



**3M** Science.  
Applied to Life.™

**3M Industrial Products for Metalworking**  
2020 Edition

# Engineered Metalworking Solutions

A worker in a blue long-sleeved shirt and grey apron is using a grinding tool on a metal pipe. The worker is wearing safety glasses, a white respirator mask, and brown leather gloves. The background shows industrial machinery and a factory setting.

# 3M innovations for every part of the metalworking industry.

For over 100 years, 3M has designed solutions specifically for the metalworking industry. Our industrial abrasives are built to withstand grinding on the toughest metal substrates, deliver fine finishes and get you through all the stages in between. In addition, 3M personal protective equipment (PPE) products are available to help ensure that your people are well protected during every step of the metalworking process, whether they are grinding, finishing or just crossing the factory floor. When combined with our selection of industrial adhesives and tapes, you and your team will be prepared for whatever challenge comes your way.

# Industrial Products for Metalworking

## 2 Right Angle Disc Systems

- 3 3M™ Depressed Center Grinding Wheels
- 4 3M™ Cubitron™ II Cut & Grind Wheels
- 5 3M™ Cut-Off Wheels
- 7 3M™ Fibre Discs
- 11 3M™ Flap Discs
- 16 Scotch-Brite™ Discs
- 21 3M™ Power Tools
- 22 Accessories

## 24 3M™ Roloc™ Systems

- 24 3M™ Roloc™ Discs
- 29 Scotch-Brite™ Roloc™ Discs
- 34 3M™ Roloc™ Disc Packs
- 35 3M™ Power Tools
- 36 Accessories

## 37 Random Orbital Systems

- 38 3M™ Cubitron™ II Discs
- 39 Scotch-Brite™ Discs
- 39 3M™ Stikit™ Discs
- 41 3M™ PSA Discs
- 42 3M™ Power Tools
- 45 Accessories

## 46 Abrasive Belt Systems

- 48 3M™ Cubitron™ II Cloth Belts
- 51 3M™ Trizact™ Cloth Belts
- 55 3M™ Belts
- 61 Scotch-Brite™ Surface Conditioning Belts
- 63 3M™ Power Tools
- 64 Accessories

## 65 Abrasive Wheel Systems

- 65 Scotch-Brite™ Convolute Wheels
- 69 Scotch-Brite™ Unitized Wheels
- 72 3M™ Flap Wheels
- 73 3M™ Power Tools
- 74 Accessories

## 76 Inline Sanding Systems

- 77 3M™ Belts and Scotch-Brite™ Belts and Brushes
- 77 3M™ Power Tools
- 78 Accessories

## 79 Hand Finishing

- 79 3M™ Abrasive Sheets
- 80 Scotch-Brite™ Hand Pads
- 82 Scotch-Brite™ Hand Pad Trial Packs
- 83 Scotch-Brite™ Rolls
- 84 3M™ Abrasive Sheets
- 86 Accessories

## 87 Specialty Abrasives

- 87 3M™ Cartridge Rolls
- 88 3M™ Square and Cross Pads
- 89 3M™ Bands
- 90 Scotch-Brite™ Specialty Abrasives
- 92 3M™ Power Tools
- 93 Accessories

## 94 Adhesives and Tapes





- 95 3M™ Aerosol Adhesives
- 96 3M™ Plastic Adhesives
- 97 3M™ Neoprene Contact Adhesives
- 98 3M™ Sealants
- 99 3M™ Scotch-Weld™ Epoxy and Acrylic Adhesives
- 101 3M™ EPX Applicators and Accessories
- 101 3M™ Scotch-Weld™ Instant Adhesives
- 102 3M™ Scotch-Weld™ Anaerobic Adhesives
- 103 3M™ VHB™ Tapes
- 103 High-Strength Bonding Tapes
- 104 Masking Made Simple
- 105 Industrial Masking Tapes
- 106 High-Strength Tapes
- 107 Scotch® Filament Tapes
- 109 Scotch® Filament Tape Dispensers
- 109 3M™ Specialty Tapes
- 111 Scotch® Box Sealing Tapes
- 112 Scotch® Box Sealing Tape Dispensers
- 113 3M™ Duct Tapes

## 114 Safety Products

- 114 3M™ Particulate Respirators
- 116 3M™ Full and Half Facepiece Reusable Respirators
- 117 3M™ Particulate Filters and Gas/Vapor Cartridges
- 118 3M™ Welding Products
- 120 Hearing Conservation
- 122 3M™ Protective Eyewear
- 124 3M™ DBI-SALA® Fall Protection
- 126 Safety Warnings

# Right Angle Disc Systems

Choose the right disc for the job.

	Depressed Center Grinding Wheels	Cut & Grind Wheels	Cut-Off Wheels	Flap Discs	Fibre Discs
					
Cutting		●	●		
Notching		●			
Gouging	●	●			
Fillet Weld Removal	●	●			
Beveling	●	●		●	●
Flame Cut Smoothing	●	●		●	●
Scale Removal	●	●		●	●
Weld Removal	●	●		●	●
Contoured Areas				●	●

**Key** ● Recommended application ● Additional application

**DO NOT USE ON TOOLS WITHOUT GUARDS.**

# 3M™ Depressed Center Grinding Wheels

## 3M™ Cubitron™ II Depressed Center Grinding Wheel – T27

- 3M precision-shaped grain for ultra fast cut and long life
- Cuts with less pressure
- Specially formulated for use on stainless and mild steel
- Cool cutting
- Available with quick change attachment
- **DO NOT USE ON TOOLS WITHOUT GUARDS**



UPC	Dia x Thk x AH	Max RPM	Min/Case
<b>T27</b>			
051115-78469-9	4" x 1/4" x 3/8"	15,300	10/20
051115-78468-2	4" x 1/4" x 5/8"	15,300	10/20
051115-78466-8	4-1/2" x 1/4" x 7/8"	13,300	10/20
051115-78467-5	5" x 1/4" x 7/8"	12,250	10/20
076308-64314-0	6" x 1/4" x 7/8"	10,200	10/20
076308-64315-7	7" x 1/4" x 7/8"	8,500	10/20
076308-64316-4	9" x 1/4" x 7/8"	6,650	10/20
<b>T27 Quick Change</b>			
076308-64320-1	4-1/2" x 1/4" x 5/8-11	13,300	10/20
076308-64317-1	5" x 1/4" x 5/8-11	12,250	10/20
076308-64318-8	6" x 1/4" x 5/8-11	10,200	10/20
076308-64319-5	7" x 1/4" x 5/8-11	8,500	10/20
051125-87153-2	9" x 1/4" x 5/8-11	6,650	10/20

## 3M™ Silver Depressed Center Grinding Wheel

- Designed for heavy grinding, beveling and weld removal
- May be used on a variety of substrates such as carbon steel and stainless steel
- 3M Precision-Shaped Grain cuts exceptionally fast, helping increase productivity
- **DO NOT USE ON TOOLS WITHOUT GUARDS**



UPC	Dia x Thk x AH	Max RPM	Min/Case
<b>T27</b>			
051125-87455-7	4" x 1/4" x 3/8"	15,300	10/20
051125-87456-4	4" x 1/4" x 5/8"	15,300	10/20
051125-87453-3	4-1/2" x 1/4" x 7/8"	13,300	10/20
051125-87454-0	5" x 1/4" x 7/8"	12,250	10/20
051125-87450-2	6" x 1/4" x 7/8"	10,200	10/20
051125-87451-9	7" x 1/4" x 7/8"	8,500	10/20
051125-87452-6	9" x 1/4" x 7/8"	6,650	10/20
<b>T27 Quick Change</b>			
051125-87397-0	4-1/2" x 1/4" x 5/8-11	13,300	10/20
051125-87446-5	5" x 1/4" x 5/8-11	12,250	10/20
051125-87447-2	6" x 1/4" x 5/8-11	10,200	10/20
051125-87448-9	7" x 1/4" x 5/8-11	8,500	10/20
051125-87449-6	9" x 1/4" x 5/8-11	6,650	10/20

## 3M™ Green Corps™ Flexible Grinding Wheel – T27

- 3M ceramic abrasive grain
- Can be used on a wide variety of metals
- Smooth running wheels produce less noise and vibration when grinding
- **DO NOT USE ON TOOLS WITHOUT GUARDS**



UPC	Dia x Thk x AH	Grade	Max RPM	Min/Case
<b>T27</b>				
051111-50440-6	4-1/2" x 1/8" x 7/8"	36	13,300	20/40
051111-50442-0	4-1/2" x 1/8" x 7/8"	46	13,300	20/40
051111-50443-7	4-1/2" x 1/8" x 7/8"	60	13,300	20/40
051111-50445-1	7" x 1/8" x 7/8"	36	8,500	20/20

## 3M™ Green Corps™ Cutting and Grinding Wheel – T27

- 3M ceramic abrasive grain
- Safe to grind outer face and cut with edge of same wheel
- **DO NOT USE ON TOOLS WITHOUT GUARDS**



UPC	Dia x Thk x AH	Grade	Max RPM	Qty/Case
<b>T27</b>				
051135-92316-0	4-1/2" x 1/8" x 7/8"	36	13,300	40
051135-92318-4	4-1/2" x 1/8" x 5/8-11 INT	36	13,300	40
051135-92317-7	7" x 1/8" x 7/8"	36	8,500	20
051135-92319-1	7" x 1/8" x 5/8-11 INT	36	8,500	20

## 3M™ General Purpose Wheel – T27

- Aluminum oxide mineral
- Durable wheel provides exceptionally long life at a value price
- Excellent, economical choice for general purpose grinding on steel
- **DO NOT USE ON TOOLS WITHOUT GUARDS**



UPC	Dia x Thk x AH	Grade	Max RPM	Qty/Case
<b>T27</b>				
051135-92312-2	4-1/2" x 1/4" x 7/8"	24	13,300	40
051135-92314-6	4-1/2" x 1/4" x 5/8-11 INT	24	13,300	40
051135-92313-9	7" x 1/4" x 7/8"	24	8,500	20
051135-92315-3	7" x 1/4" x 5/8-11 INT	24	8,500	20

## 3M™ Cubitron™ II Cut & Grind Wheels

If you're looking for a simple, effective way to boost shop productivity, new 3M™ Cubitron™ II Cut & Grind Wheels are the answer! These versatile bonded wheels are designed to be used both like a depressed center grinding wheel and as a cut-off wheel — making them ideal for cutting, grinding, gouging and more.

### 3M™ Cubitron™ II Cut & Grind Wheels – T27

- 3M precision-shaped grain for super fast cut and long life
- Versatile — can be used as both a grinding wheel and a cut-off wheel
- Optimized for use on mild steel and stainless steel — for cutting, gouging, beveling, notching and fillet weld removal
- Available with quick change attachment
- **DO NOT USE ON TOOLS WITHOUT GUARDS**



UPC	Dia x Thk x AH	Max RPM	Min/Case
<b>T27</b>			
046719-82276-8	4" x 1/8" x 3/8"	15,300	10/20
046719-82278-2	5" x 1/8" x 7/8"	12,250	10/20
046719-82279-9	4-1/2" x 1/8" x 7/8"	13,300	10/20
051141-28758-4	6" x 1/8" x 7/8"	10,200	10/20
051141-28760-7	7" x 1/8" x 7/8"	8,500	10/20
051141-28761-4	9" x 1/8" x 7/8"	6,650	10/20
<b>T27 Quick Change</b>			
051141-28762-1	4-1/2" x 1/8" x 5/8-11	13,300	10/20
051141-28763-8	5" x 1/8" x 5/8-11	12,250	10/20
051141-28764-5	6" x 1/8" x 5/8-11	10,200	10/20
051141-28765-2	7" x 1/8" x 5/8-11	8,500	10/20
051141-28766-9	9" x 1/8" x 5/8-11	6,650	10/20



# 3M™ Cut-Off Wheels

Durable and fast-cutting wheels for your toughest cutting applications. Run with 3M™ Cut-Off Wheel Tools for optimal performance. For use on all metals.

3M™ Cut-Off Wheels Selection Guide			
Product	Mineral Type	Type	Performance
3M™ Cubitron™ II	Precision-Shaped Grain	T1	Premium
		T27	Premium
3M™ Silver	Precision-Shaped Grain Blend	T1	Advanced
		T27	Advanced

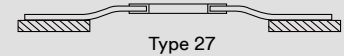
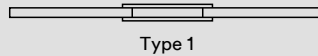

## 3M™ Cubitron™ II Cut-Off Wheel – T1

- Premium performance
- 3M precision-shaped grain for ultra-fast cool cutting action and long life
- Cuts with less pressure
- Cool cutting
- Specially formulated for use on stainless and mild steel



UPC	Dia x Thk x AH	Max RPM	Min/Case
<b>T1</b>			
051115-66513-4	3" x .035" x 1/4"	25,465	25/50
051115-66514-1	3" x .035" x 3/8"	25,465	25/50
051115-66516-5	3" x .06" x 3/8"	25,465	25/50
051115-66518-9	4" x .035" x 3/8"	19,100	25/50
051115-66520-2	4" x .06" x 3/8"	19,100	25/50
051115-66524-0	4" x .125" x 3/8"	19,100	25/50
051125-86929-4	4-1/2" x .040" x 7/8"	13,300	25/50
051115-66525-7	4-1/2" x .045" x 7/8"	13,300	25/50
051115-66526-4	5" x .045" x 7/8"	12,250	25/50
051115-66527-1	6" x .045" x 7/8"	10,200	25/50
051115-66528-8	7" x .045" x 7/8"	8,500	25/50

## 3M™ Cubitron™ II Cut-Off Wheel – T27

- Premium performance
- 3M precision-shaped grain for ultra-fast cool cutting action and long life
- Cuts with less pressure
- Specially formulated for use on stainless and mild steel
- Available with quick change attachment



UPC	Dia x Thk x AH	Max RPM	Min/Case
<b>T27</b>			
051125-86946-1	4-1/2" x .040" x 7/8"	13,300	25/50
051115-66531-8	4-1/2" x .045" x 7/8"	13,300	25/50
051115-66535-6	4-1/2" x .125" x 7/8"	13,300	25/50
051125-86945-4	5" x .040" x 7/8"	12,250	25/50
051115-66537-0	5" x .045" x 7/8"	12,250	25/50
051115-66539-4	5" x .09" x 7/8"	12,250	25/50
051115-66541-7	6" x .045" x 7/8"	10,200	25/50
051115-66543-1	7" x .09" x 7/8"	8,500	25/50
<b>T27 Quick Change</b>			
051115-66530-1	4-1/2" x .045" x 5/8-11	13,300	25/50
051115-66532-5	4-1/2" x .09" x 5/8-11	13,300	25/50
051115-66534-9	4-1/2" x .125" x 5/8-11	13,300	25/50
051115-66540-0	6" x .045" x 5/8-11	10,200	25/50
051115-66542-4	7" x .09" x 5/8-11	8,500	25/50

For safe applications using cut-off wheels, refer to ANSI B-7.1 for details. **ALWAYS** use appropriate wheel guards. Refer to ANSI B-186.1 for guarding requirements.

## 3M™ Cut-Off Wheels

### 3M™ Silver Cut-Off Wheel – T1

- Designed to quickly cut through metal pipes, tubes flat sheets and more
- Exceptional durability extends the life of the wheel for great performance value
- 3M Precision-Shaped Grain cuts exceptionally fast, helping increase productivity
- May be used on a variety of substrates such as carbon steel and stainless steel



UPC	Dia x Thk x AH	Max RPM	Min/Case
T1			
051125-87457-1	3" x .035" x 1/4	25,465	25/50
051125-87458-8	3" x .035" x 3/8	25,465	25/50
051125-87459-5	3" x .060" x 3/8	25,465	25/50
051125-87460-1	4" x .035" x 1/4	19,100	25/50
051125-87461-8	4" x .035" x 3/8	19,100	25/50
051125-87462-5	4" x .060" x 3/8	19,100	25/50
051125-87657-5	4" x 0.125" x 3/8	19,100	25/50
051125-87464-9	4-1/2" x .040" x 7/8	13,300	25/50
051125-87465-6	4-1/2" x .045" x 7/8	13,300	25/50
051125-87467-0	5" x .045" x 7/8	12,250	25/50
051125-87469-4	6" x .045" x 7/8	10,200	25/50
051125-87471-7	7" x .045" x 7/8	8,500	25/50

### 3M™ Silver Cut-Off Wheel – T27

- Designed to quickly cut through metal pipes, tubes flat sheets and more
- Exceptional durability extends the life of the wheel for great performance value
- 3M Precision-Shaped Grain cuts exceptionally fast, helping increase productivity
- May be used on a variety of substrates such as carbon steel and stainless steel



UPC	Dia x Thk x AH	Max RPM	Min/Case
T27			
051125-87466-3	4-1/2" x .045" x 7/8	13,300	25/50
051125-87659-9	4-1/2" x .090" x 7/8	13,300	25/50
051125-87468-7	5" x .045" x 7/8	12,250	10/20
051125-87470-0	6" x .045" x 7/8	10,200	10/20

For safe applications using cut-off wheels, refer to ANSI B-7.1 for details. **ALWAYS** use appropriate wheel guards. Refer to ANSI B-186.1 for guarding requirements.

## 3M™ Fibre Discs

Choose the performance level that fits your needs with a complete offering of 3M™ Fibre Discs. Get great performance at a great price with the general purpose metalworking 3M™ Fibre Disc 381C. Or, set a new standard for productivity with 3M™ Cubitron™ II 982C Discs. All of 3M's fibre discs are available in a variety of sizes.

### Selection Guide for Carbon Steel

For fast cutting when grinding and blending carbon steel.

Product	Mineral Type	Performance
3M™ Cubitron™ II Fibre Disc 982C	Precision-Shaped Grain	Premium
3M™ Fibre Disc 782C	Precision-Shaped Grain	Advanced
3M™ Fibre Disc 501C	Alumina Zirconia	Good
3M™ Fibre Disc 381C	Aluminum Oxide	Good

See digital catalog for additional product skus.

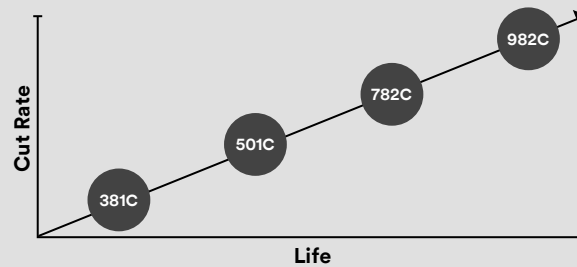

### Selection Guide for Stainless Steel or Aluminum

For fast cutting when grinding and blending stainless steel or aluminum.

Product	Mineral Type	Performance
3M™ Cubitron™ II Fibre Disc 987C	Precision-Shaped Grain	Premium
3M™ Fibre Disc 787C	Precision-Shaped Grain	Advanced
3M™ Fibre Disc 501C	Alumina Zirconia	Good

See digital catalog for additional product skus.

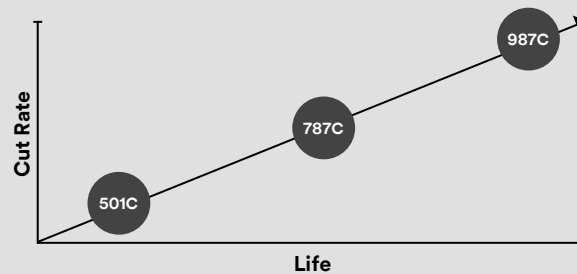

# 3M™ Fibre Discs

## 3M™ Cubitron™ II Fibre Disc 982C

- 3M precision-shaped grain, engineered with ultra-sharp, fast cutting points that wear evenly, run cool, and optimize mineral breakdown to maximize life
- Best in class for weld prep and removal on carbon steel applications

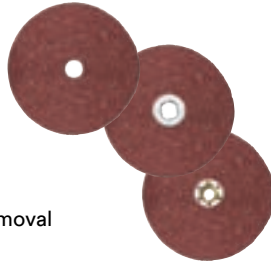

UPC	Dia x Ctr Hole	Grade	Max RPM	Min/Case
051141-27400-3	4-1/2" x 7/8"	36+	13,300	25/100
051141-27631-1	4-1/2" x 7/8"	60+	13,300	25/100
051141-27635-9	4-1/2" x 7/8"	80+	13,300	25/100
051141-27401-0	5" x 7/8"	36+	12,000	25/100
051141-27632-8	5" x 7/8"	60+	12,000	25/100
051141-27636-6	5" x 7/8"	80+	12,000	25/100
051141-27402-7	7" x 7/8"	36+	8,600	25/100
051141-27633-5	7" x 7/8"	60+	8,600	25/100
051141-27637-3	7" x 7/8"	80+	8,600	25/100
051141-27403-4	9-1/8" x 7/8"	36+	6,600	25/100
051141-27634-2	9-1/8" x 7/8"	60+	6,600	25/100
051141-27638-0	9-1/8" x 7/8"	80+	6,600	25/100

### TN Quick Change

051141-27425-6	4-1/2" x 5/8-11	36+	13,300	25/100
051141-27639-7	4-1/2" x 5/8-11	60+	13,300	25/100
051141-27642-7	4-1/2" x 5/8-11	80+	13,300	25/100
051141-27404-1	5" x 5/8-11	36+	12,000	25/100
051141-27640-3	5" x 5/8-11	60+	12,000	25/100
051141-27643-4	5" x 5/8-11	80+	12,000	25/100
051141-27405-8	7" x 5/8-11	36+	8,600	25/100
051141-27641-0	7" x 5/8-11	60+	8,600	25/100
051141-27644-1	7" x 5/8-11	80+	8,600	25/100

### GL Quick Change

051141-27406-5	5" x 5/8-11	36+	12,000	25/100
051141-27724-0	5" x 5/8-11	60+	12,000	25/100
051141-27726-4	5" x 5/8-11	80+	12,000	25/100
051141-27407-2	7" x 5/8-11	36+	8,600	25/100
051141-27725-7	7" x 5/8-11	60+	8,600	25/100
051141-27727-1	7" x 5/8-11	80+	8,600	25/100

## 3M™ Cubitron™ II Fibre Disc 987C

- 3M precision-shaped grain, engineered with ultra-sharp, fast cutting points that wear evenly, run cool, and optimize mineral breakdown to maximize life
- Best in class for weld prep and removal on heat sensitive alloys such as stainless steel

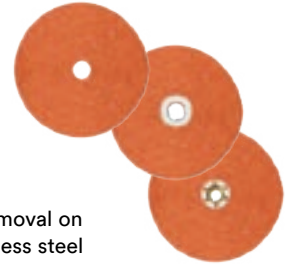

UPC	Dia x Ctr Hole	Grade	Max RPM	Min/Case
051141-27447-8	4-1/2" x 7/8"	36+	13,300	25/100
051141-27653-3	4-1/2" x 7/8"	60+	13,300	25/100
051141-27657-1	4-1/2" x 7/8"	80+	13,300	25/100
051141-27448-5	5" x 7/8"	36+	12,000	25/100
051141-27654-0	5" x 7/8"	60+	12,000	25/100
051141-27658-8	5" x 7/8"	80+	12,000	25/100
051141-27449-2	7" x 7/8"	36+	8,600	25/100
051141-27655-7	7" x 7/8"	60+	8,600	25/100
051141-27659-5	7" x 7/8"	80+	8,600	25/100
051141-27450-8	9-1/8" x 7/8"	36+	6,600	25/100
051141-27656-4	9-1/8" x 7/8"	60+	6,600	25/100
051141-27660-1	9-1/8" x 7/8"	80+	6,600	25/100

### TN Quick Change

051141-27469-0	4-1/2"	36+	13,300	25/100
051141-27661-8	4-1/2"	60+	13,300	25/100
051141-27664-9	4-1/2"	80+	13,300	25/100
051141-27467-6	5"	36+	12,000	25/100
051141-27662-5	5"	60+	12,000	25/100
051141-27665-6	5"	80+	12,000	25/100
051141-27468-3	7"	36+	8,600	25/100
051141-27663-2	7"	60+	8,600	25/100
051141-27666-3	7"	80+	8,600	25/100

### GL Quick Change

051141-27728-8	5"	36+	12,000	25/100
051141-27732-5	5"	80+	12,000	25/100
051141-27729-5	7"	36+	8,600	25/100
051141-27731-8	7"	60+	8,600	25/100
051141-27733-2	7"	80+	8,600	25/100

## 3M™ Fibre Discs Outlast Conventional Ceramic Discs

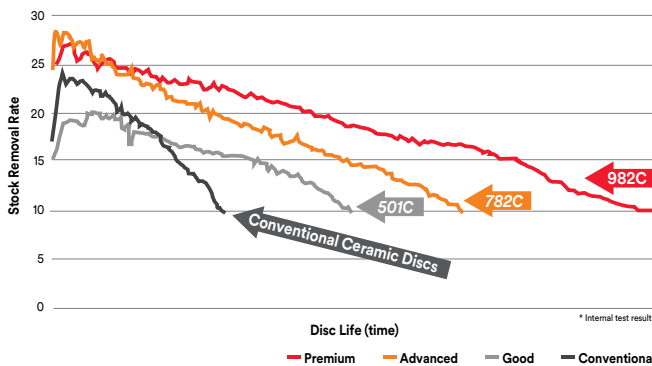

### What's the difference between 3M™ Cubitron™ II Fibre Discs and 3M™ Fibre Discs with Precision-Shaped Grain?

3M™ Cubitron™ II Fibre Discs provide a fast cut and very long life, making them an ideal choice for heavy volume production applications.

If your customer still wants a very fast cut but is price sensitive, or doesn't need the extreme long life of a 3M™ Cubitron™ II Disc, 3M™ Fibre Discs 782C is an ideal alternative that outlasts conventional ceramic discs.\*

## 3M™ Fibre Discs

### 3M™ Fibre Disc 782C for Carbon Steel

- Ideal choice for carbon steel
- Offer a faster cut and longer life than alumina zirconia (AZ) and conventional ceramic abrasives
- These discs also require less grinding pressure for easier operation

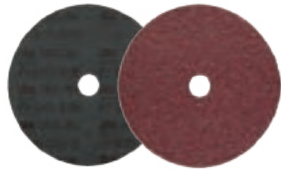

UPC	Diameter*	Grade	Max RPM	Qty/Case
076308-89589-1	4-1/2" x 7/8"	36+	13,300	100
076308-89598-3	4-1/2" x 7/8"	60+	13,300	100
076308-89607-2	4-1/2" x 7/8"	80+	13,300	100
076308-89590-7	5" x 7/8"	36+	12,000	100
076308-89599-0	5" x 7/8"	60+	12,000	100
076308-89608-9	5" x 7/8"	80+	12,000	100
076308-89591-4	7" x 7/8"	36+	8,600	100
076308-89600-3	7" x 7/8"	60+	8,600	100
076308-89609-6	7" x 7/8"	80+	8,600	100
076308-89592-1	9-1/8" x 7/8"	36+	6,600	100
076308-89601-0	9-1/8" x 7/8"	60+	6,600	100
076308-89610-2	9-1/8" x 7/8"	80+	6,600	100

#### TN Quick Change

076308-89595-2	4-1/2" x 5/8-11	36+	13,300	100
076308-89604-1	4-1/2" x 5/8-11	60+	13,300	100
076308-89613-3	4-1/2" x 5/8-11	80+	13,300	100
076308-89596-9	5" x 5/8-11	36+	12,000	100
076308-89605-8	5" x 5/8-11	60+	12,000	100
076308-89614-0	5" x 5/8-11	80+	12,000	100
076308-89597-6	7" x 5/8-11	36+	8,600	100
076308-89606-5	7" x 5/8-11	60+	8,600	100
076308-89615-7	7" x 5/8-11	80+	8,600	100

\*Other sizes available upon request.

### Tech tip

#### Weld Blending Mild Steel for Paint Prep

**Step 1** Fibre Disc 982C Grade 36+

**Step 2** Scotch-Brite™ Light Grinding and Blending Disc SD on black ribbed pad

**Step 3** Apply 3 mil paint

**Results** Increase productivity; reduce abrasive cost

### 3M™ Fibre Disc 787C for Stainless Steel Non-Ferrous Metals

- Optimized for stainless steel and non-ferrous metals like aluminum and titanium
- Cuts cooler, faster and lasts longer than conventional ceramic discs in applications like weld removal, beveling, edge chamfering and more



- Key Product Highlights:
  - Made with 3M Precision-Shaped Grain, for outstanding speed and long life
  - Great for grinding, weld removal, beveling and edge chamfering
  - Cuts cooler, faster and longer than alumina zirconia (AZ) and conventional ceramic abrasives

UPC	Diameter*	Grade	Max RPM	Qty/Case
076308-89627-0	4-1/2" x 7/8"	36+	13,300	100
076308-89636-2	4-1/2" x 7/8"	60+	13,300	100
076308-89645-4	4-1/2" x 7/8"	80+	13,300	100
076308-89654-6	4-1/2" x 7/8"	120+	13,300	100
076308-89628-7	5" x 7/8"	36+	12,000	100
076308-89637-9	5" x 7/8"	60+	12,000	100
076308-89646-1	5" x 7/8"	80+	12,000	100
076308-89655-3	5" x 7/8"	120+	12,000	100
076308-89629-4	7" x 7/8"	36+	8,600	100
076308-89638-6	7" x 7/8"	60+	8,600	100
076308-89647-8	7" x 7/8"	80+	8,600	100
076308-89656-0	7" x 7/8"	120+	8,600	100
076308-89630-0	9-1/8" x 7/8"	36+	6,600	100
076308-89639-3	9-1/8" x 7/8"	60+	6,600	100
076308-89648-5	9-1/8" x 7/8"	80+	6,600	100
076308-89657-7	9-1/8" x 7/8"	120+	6,600	100

#### TN Quick Change

076308-89633-1	4-1/2" x 5/8-11	36+	13,000	100
076308-89642-3	4-1/2" x 5/8-11	60+	13,000	100
076308-89651-5	4-1/2" x 5/8-11	80+	13,000	100
076308-89658-4	4-1/2" x 5/8-11	120+	13,000	100
076308-89634-8	5" x 5/8-11	36+	12,000	100
076308-89643-0	5" x 5/8-11	60+	12,000	100
076308-89652-2	5" x 5/8-11	80+	12,000	100
076308-89659-1	5" x 5/8-11	120+	12,000	100
076308-89635-5	7" x 5/8-11	36+	8,600	100
076308-89644-7	7" x 5/8-11	60+	8,600	100
076308-89653-9	7" x 5/8-11	80+	8,600	100
076308-89660-7	7" x 5/8-11	120+	8,600	100

\*Other sizes available upon request.

# 3M™ Fibre Discs

## 3M™ Fibre Discs 381C

- General purpose disc for weld removal, grinding and blending
- Resin bond aluminum oxide provides durability and aggressive stock removal



UPC	Dia x Ctr Hole	Grade	Max RPM	Min/Case
051144-77595-8	4-1/2" x 7/8"	24	13,300	25
051144-77596-5	4-1/2" x 7/8"	36	13,300	25
051144-77597-2	4-1/2" x 7/8"	50	13,300	25
051144-77598-9	4-1/2" x 7/8"	60	13,300	25
051144-77599-6	4-1/2" x 7/8"	80	13,300	25
051144-77600-9	4-1/2" x 7/8"	100	13,300	25
051144-77601-6	4-1/2" x 7/8"	120	13,300	25
051144-81369-8	5" x 7/8"	24	12,000	25
051144-81372-8	5" x 7/8"	36	12,000	25
051144-81375-9	5" x 7/8"	50	12,000	25
051144-01727-0	5" x 7/8"	60	12,000	25
051144-20054-2	5" x 7/8"	80	12,000	25
051144-20053-5	5" x 7/8"	100	12,000	25
051144-20052-8	5" x 7/8"	120	12,000	25
051144-01745-4	7" x 7/8"	16	8,600	25
051144-81370-4	7" x 7/8"	24	8,600	25
051144-81373-5	7" x 7/8"	36	8,600	25
051144-81376-6	7" x 7/8"	50	8,600	25
051144-01741-6	7" x 7/8"	60	8,600	25
051144-01740-9	7" x 7/8"	80	8,600	25
051144-01739-3	7" x 7/8"	100	8,600	25
051144-01738-6	7" x 7/8"	120	8,600	25
051144-01762-1	9-1/8" x 7/8"	80	6,600	25
051144-01761-4†	9-1/8" x 7/8"	100	6,600	25
051144-01760-7†	9-1/8" x 7/8"	120	6,600	25

†Made-to-Order

## 3M™ Fibre Discs 501C

- Versatile disc for use on a wide variety of metals
- Aluminum zirconia provides a good option for stainless, aluminum and mild steel applications



UPC	Dia x Ctr Hole	Grade	Max RPM	Min/Case
051111-50409-3	4-1/2" x 7/8"	24	13,300	25/100
051111-50413-0	4-1/2" x 7/8"	36	13,300	25/100
051111-50414-7	4-1/2" x 7/8"	50	13,300	25/100
051111-50415-4	4-1/2" x 7/8"	60	13,300	25/100
051111-50416-1	4-1/2" x 7/8"	80	13,300	25/100
051111-50417-8	4-1/2" x 7/8"	100	13,300	25/100
051111-50419-2	4-1/2" x 7/8"	120	13,300	25/100
051111-50410-9	5" x 7/8"	24	12,000	25/100
051111-50412-3	5" x 7/8"	36	12,000	25/100
051111-50420-8	5" x 7/8"	50	12,000	25/100
051111-50421-5	5" x 7/8"	60	12,000	25/100
051111-50422-2	5" x 7/8"	80	12,000	25/100
051111-50423-9	5" x 7/8"	100	12,000	25/100
051111-50424-6	5" x 7/8"	120	12,000	25/100
051111-50411-6	7" x 7/8"	24	8,600	25/100
051111-50426-0	7" x 7/8"	36	8,600	25/100
051111-50425-3	7" x 7/8"	50	8,600	25/100
051111-50427-7	7" x 7/8"	60	8,600	25/100
051111-50428-4	7" x 7/8"	80	8,600	25/100
051111-50430-7†	7" x 7/8"	120	8,600	25/100
051111-50432-1†	9-1/8" x 7/8"	24	6,600	25/100
051111-50434-5†	9-1/8" x 7/8"	50	6,600	25/100

†Made-to-Order

### Tech tip

Use 3M™ Disc Pad Face Plates – Red Ribbed to optimize product life of 3M™ Cubitron™ II Fibre Discs – grade 36+.

Choose from a range of diameters: 4-1/2" (28443), 5" (81732), 7" (80514), 9" (81728).

Note: See 3M™ Disc Pad Face Plate Accessories on page 23 for more information.



# 3M™ Flap Discs

3M™ Flap Discs offer an unbeatable system for grinding and blending in one easy step. The construction wears away, exposing fresh mineral to extend disc life and provide consistent cut rates. Great for weld grinding, blending, deburring, rust removal, surface prep and edge grinding on all types of metals. Available in both T29 or T27 constructions with or without the 5/8–11 hub.

3M™ Flap Disc Selection Guide				4-1/2" x 7/8"		4-1/2" x 5/8-11		7" x 7/8"		7" x 5/8-11	
Product	Mineral Type	Type of Backing	Performance	T27	T29	T27	T29	T27	T29	T27	T29
3M™ Cubitron™ II Flap Disc 967A	Precision-Shaped Grain	Cloth	Premium	●	●	●	●	●	●	●	●
3M™ Cubitron™ II Flap Disc 969F	Precision-Shaped Grain	Polyester	Premium	●	●	●	●	●	●	●	●
3M™ Flap Disc 769F	Precision-Shaped Grain	Polyester	Advanced	●	●	●	●	●	●	●	●
3M™ Flap Disc 577F	Alumina Zirconia	Polyester Cloth	Good	●	●	●	●	●	●	●	●

## Performance Under Pressure: Choose the right disc for the job

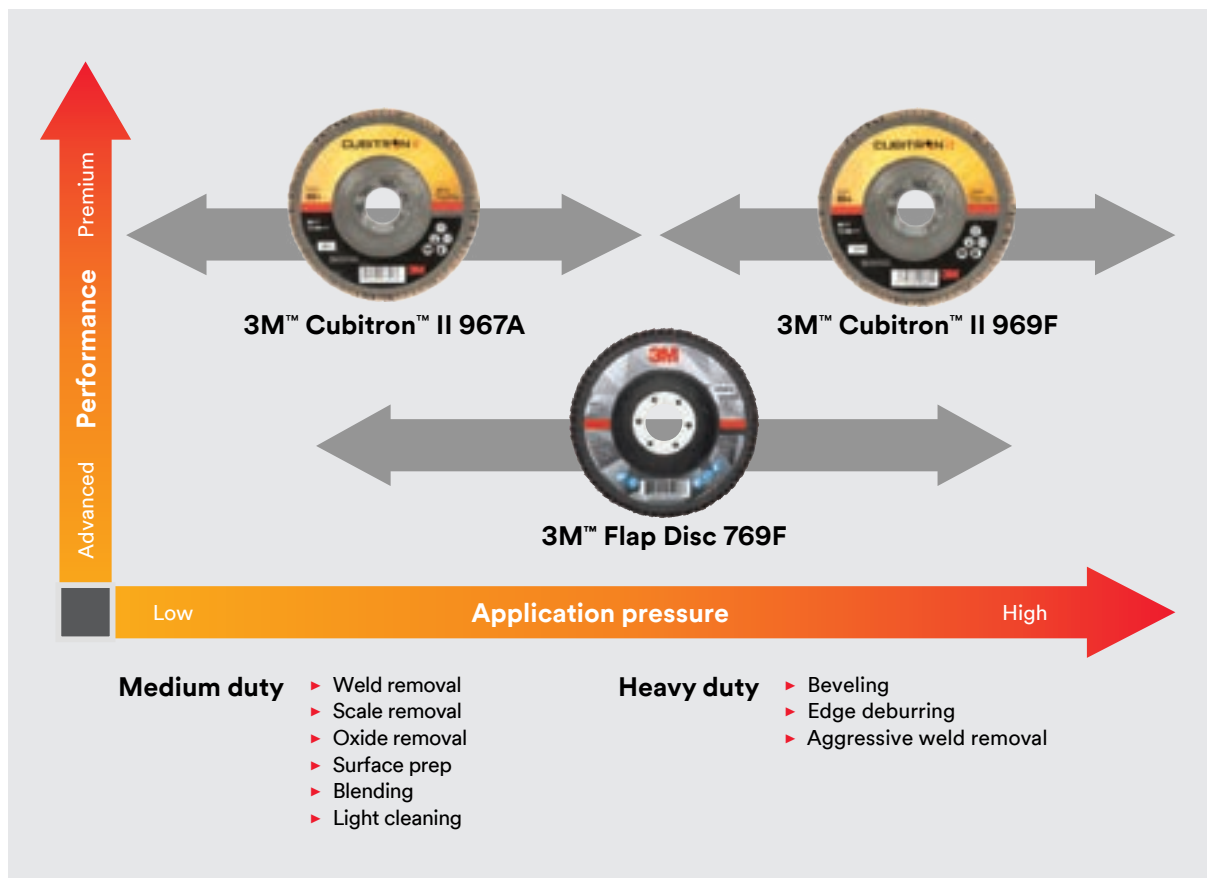

## 3M™ Flap Discs

### 3M™ Cubitron™ II Flap Discs 967A

- Made with revolutionary 3M precision-shaped grain
- Grinds and blends in a single step
- Flexible to follow curves and contours
- Long-life and consistency at any grinding pressure
- Constructed with a poly-cotton backing that exposes fresh mineral as it wears, for a fast, forgiving cut

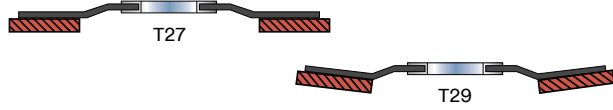

UPC	Dia x Ctr Hole	Grade	Max RPM	Qty/Case
<b>T27</b>				
051141-55605-5	4-1/2" x 7/8"	40+	13,300	10
051141-55606-2	4-1/2" x 7/8"	60+	13,300	10
051141-55607-9	4-1/2" x 7/8"	80+	13,300	10
051141-55635-2	4-1/2" x 7/8" Giant	40+	13,300	10
051141-55636-9	4-1/2" x 7/8" Giant	60+	13,300	10
051141-55637-6	4-1/2" x 7/8" Giant	80+	13,300	10
051125-86715-3	5" x 7/8"	40+	12,000	10
051125-86718-4	5" x 7/8"	60+	12,000	10
051125-86719-1	5" x 7/8"	80+	12,000	10
051141-55611-6	7" x 7/8"	40+	8,600	5
051141-55612-3	7" x 7/8"	60+	8,600	5
051141-55613-0	7" x 7/8"	80+	8,600	5
051141-55641-3	7" x 7/8" Giant	40+	8,600	5
051141-55642-0	7" x 7/8" Giant	60+	8,600	5
051141-55643-7	7" x 7/8" Giant	80+	8,600	5
<b>T27 Quick Change</b>				
051141-55602-4	4-1/2" x 5/8-11	40+	13,300	10
051141-55603-1	4-1/2" x 5/8-11	60+	13,300	10
051141-55604-8	4-1/2" x 5/8-11	80+	13,300	10
051141-55632-1	4-1/2" x 5/8-11 Giant	40+	13,300	10
051141-55633-8	4-1/2" x 5/8-11 Giant	60+	13,300	10
051141-55634-5	4-1/2" x 5/8-11 Giant	80+	13,300	10
051141-55608-6	7" x 5/8-11	40+	8,600	5
051141-55609-3	7" x 5/8-11	60+	8,600	5
051141-55610-9	7" x 5/8-11	80+	8,600	5
051141-55638-3	7" x 5/8-11 Giant	40+	8,600	5
051141-55639-0	7" x 5/8-11 Giant	60+	8,600	5
051141-55640-6	7" x 5/8-11 Giant	80+	8,600	5

UPC	Dia x Ctr Hole	Grade	Max RPM	Qty/Case
<b>T29</b>				
051141-55617-8	4" x 5/8	40+	13,300	10
051141-55618-5	4" x 5/8	60+	13,300	10
051141-55619-2	4" x 5/8	80+	13,300	10
051141-55623-9	4-1/2" x 7/8"	40+	13,300	10
051141-55624-6	4-1/2" x 7/8"	60+	13,300	10
051141-55625-3	4-1/2" x 7/8"	80+	13,300	10
051141-55647-5	4-1/2" x 7/8" Giant	40+	13,300	10
051141-55648-2	4-1/2" x 7/8" Giant	60+	13,300	10
051141-55649-9	4-1/2" x 7/8" Giant	80+	13,300	10
051125-86716-0	5" x 7/8	40+	12,000	10
051125-86717-7	5" x 7/8	60+	12,000	10
051125-86720-7	5" x 7/8	80+	12,000	10
051141-55629-1	7" x 7/8"	40+	8,600	5
051141-55630-7	7" x 7/8"	60+	8,600	5
051141-55631-4	7" x 7/8"	80+	8,600	5
051141-55653-6	7" x 7/8" Giant	40+	8,600	5
051141-55654-3	7" x 7/8" Giant	60+	8,600	5
051141-55655-0	7" x 7/8" Giant	80+	8,600	5
<b>T29 Quick Change</b>				
051141-55614-7	4" x 3/8-24	40+	13,300	10
051141-55615-4	4" x 3/8-24	60+	13,300	10
051141-55616-1	4" x 3/8-24	80+	13,300	10
051141-55620-8	4-1/2" x 5/8-11	40+	13,300	10
051141-55621-5	4-1/2" x 5/8-11	60+	13,300	10
051141-55622-2	4-1/2" x 5/8-11	80+	13,300	10
051141-55644-4	4-1/2" x 5/8-11 Giant	40+	13,300	10
051141-55645-1	4-1/2" x 5/8-11 Giant	60+	13,300	10
051141-55646-8	4-1/2" x 5/8-11 Giant	80+	13,300	10
051141-54180-8	5" x 5/8-11	40+	12,000	10
051141-54181-5	5" x 5/8-11	60+	12,000	10
051141-55626-0	7" x 5/8-11	40+	8,600	5
051141-55627-7	7" x 5/8-11	60+	8,600	5
051141-55628-4	7" x 5/8-11	80+	8,600	5
051141-55650-5	7" x 5/8-11 Giant	40+	8,600	5
051141-55651-2	7" x 5/8-11 Giant	60+	8,600	5
051141-55652-9	7" x 5/8-11 Giant	80+	8,600	5

# 3M™ Flap Discs

## 3M™ Cubitron™ II Flap Discs 969F

- Features tough polyester backing to hold up under demanding applications like grinding, edge deburring and beveling
- Flap construction contains more abrasive material, for longer life
- For medium duty applications try 3M™ Cubitron™ II Flap Disc 967A

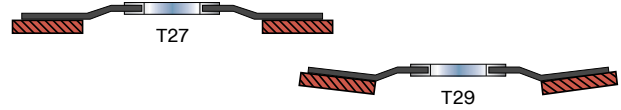

UPC	Dia x Ctr Hole	Grade	Max RPM	Qty/Case
<b>T27</b>				
076308-64376-8	4-1/2" x 7/8"	40+	13,300	10
076308-64377-5	4-1/2" x 7/8"	60+	13,300	10
076308-64378-2	4-1/2" x 7/8"	80+	13,300	10
076308-64406-2	4-1/2" x 7/8" Giant	40+	13,300	10
076308-64407-9	4-1/2" x 7/8" Giant	60+	13,300	10
076308-64408-6	4-1/2" x 7/8" Giant	80+	13,300	10
076308-89844-1	5" x 7/8"	40+	12,000	10
076308-89847-2	5" x 7/8"	60+	12,000	10
076308-89848-9	5" x 7/8"	80+	12,000	10
076308-64382-9	7" x 7/8"	40+	8,600	5
076308-64383-6	7" x 7/8"	60+	8,600	5
076308-64384-3	7" x 7/8"	80+	8,600	5
076308-64412-3	7" x 7/8" Giant	40+	8,600	5
076308-64413-0	7" x 7/8" Giant	60+	8,600	5
076308-64414-7	7" x 7/8" Giant	80+	8,600	5
<b>T27 Quick Change</b>				
076308-64373-7	4-1/2" x 5/8-11	40+	13,300	10
076308-64374-4	4-1/2" x 5/8-11	60+	13,300	10
076308-64375-1	4-1/2" x 5/8-11	80+	13,300	10
076308-64403-1	4-1/2" x 5/8-11 Giant	40+	13,300	10
076308-64404-8	4-1/2" x 5/8-11 Giant	60+	13,300	10
076308-64405-5	4-1/2" x 5/8-11 Giant	80+	13,300	10
076308-64367-6	5 in x 5/8-11	40+	12,000	10
076308-64370-6	5 in x 5/8-11	60+	12,000	10
076308-64371-3	5 in x 5/8-11	80+	12,000	10
076308-64379-9	7" x 5/8-11	40+	8,600	5
076308-64380-5	7" x 5/8-11	60+	8,600	5
076308-64381-2	7" x 5/8-11	80+	8,600	5
076308-64409-3	7" x 5/8-11 Giant	40+	8,600	5
076308-64410-9	7" x 5/8-11 Giant	60+	8,600	5
076308-64411-6	7" x 5/8-11 Giant	80+	8,600	5

UPC	Dia x Ctr Hole	Grade	Max RPM	Qty/Case
<b>T29</b>				
076308-64385-0	4" x 3/8-24	40+	15,000	10
076308-64386-7	4" x 3/8-24	60+	15,000	10
076308-64387-4	4" x 3/8-24	80+	15,000	10
076308-64388-1	4" x 5/8"	40+	15,000	10
076308-64389-8	4" x 5/8"	60+	15,000	10
076308-64390-4	4" x 5/8"	80+	15,000	10
076308-64394-2	4-1/2" x 7/8"	40+	13,300	10
076308-64395-9	4-1/2" x 7/8"	60+	13,300	10
076308-64396-6	4-1/2" x 7/8"	80+	13,300	10
076308-64418-5	4-1/2" x 7/8" Giant	40+	13,300	10
076308-64419-2	4-1/2" x 7/8" Giant	60+	13,300	10
076308-64420-8	4-1/2" x 7/8" Giant	80+	13,300	10
076308-89845-8	5" x 7/8"	40+	12,000	10
076308-89846-5	5" x 7/8"	60+	12,000	10
076308-89849-6	5" x 7/8"	80+	12,000	10
076308-64400-0	7" x 7/8"	40+	8,600	5
076308-64401-7	7" x 7/8"	60+	8,600	5
076308-64402-4	7" x 7/8"	80+	8,600	5
076308-64424-6	7" x 7/8" Giant	40+	8,600	5
076308-64425-3	7" x 7/8" Giant	60+	8,600	5
076308-64426-0	7" x 7/8" Giant	80+	8,600	5
<b>T29 Quick Change</b>				
076308-64391-1	4-1/2" x 5/8-11	40+	13,300	10
076308-64392-8	4-1/2" x 5/8-11	60+	13,300	10
076308-64393-5	4-1/2" x 5/8-11	80+	13,300	10
076308-64415-4	4-1/2" x 5/8-11 Giant	40+	13,300	10
076308-64416-1	4-1/2" x 5/8-11 Giant	60+	13,300	10
076308-64417-8	4-1/2" x 5/8-11 Giant	80+	13,300	10
076308-64368-3	5 in x 5/8-11	40+	12,000	10
076308-64369-0	5 in x 5/8-11	60+	12,000	10
076308-64372-0	5 in x 5/8-11	80+	12,000	10
076308-64397-3	7" x 5/8-11	40+	8,600	10
076308-64398-0	7" x 5/8-11	60+	8,600	10
076308-64399-7	7" x 5/8-11	80+	8,600	10
076308-64421-5	7" x 5/8-11 Giant	40+	8,600	5
076308-64422-2	7" x 5/8-11 Giant	60+	8,600	5
076308-64423-9	7" x 5/8-11 Giant	80+	8,600	5

### Tech tip

Flap discs typically provide a finish one grade finer than they are graded.

## 3M™ Flap Discs

### 3M™ Flap Discs 769F

- Fast, consistent cut and long life
- Ideal for a range of medium- and heavy-duty applications
- Smooth “feel” for operator comfort and ease of use
- Durable polyester backing
- Now available with a new, lightweight and rugged plastic Quick Change hub attachment

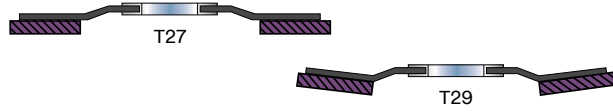

UPC	Dia x Ctr Hole	Grade	Max RPM	Qty/Case
<b>T27</b>				
638060-05903-6	4.5" x 7/8"	40+	13,300	10
638060-05904-3	4.5" x 7/8"	60+	13,300	10
638060-05905-0	4.5" x 7/8"	80+	13,300	10
638060-05924-1	4.5" x 7/8"	120+	13,300	10
638060-05915-9	5" x 7/8"	40+	12,000	10
638060-05918-0	5" x 7/8"	60+	12,000	10
638060-05919-7	5" x 7/8"	80+	12,000	10
638060-05928-9	5" x 7/8"	120+	12,000	10
638060-05909-8	7" x 7/8"	40+	8,600	5
638060-05910-4	7" x 7/8"	60+	8,600	5
638060-05911-1	7" x 7/8"	80+	8,600	5
638060-05926-5	7" x 7/8"	120+	8,600	5
<b>T27 Quick Change</b>				
638060-05933-3	4.5" x 5/8-11	40+	13,300	10
638060-05934-0	4.5" x 5/8-11	60+	13,300	10
638060-05935-7	4.5" x 5/8-11	80+	13,300	10
638060-05936-4	4.5" x 5/8-11	120+	13,300	10
638060-05946-3	5" x 5/8-11	40+	12,000	10
638060-05949-4	5" x 5/8-11	60+	12,000	10
638060-05950-0	5" x 5/8-11	80+	12,000	10
638060-05940-1	7" x 5/8-11	40+	8,600	5
638060-05941-8	7" x 5/8-11	60+	8,600	5
638060-05942-5	7" x 5/8-11	80+	8,600	5

UPC	Dia x Ctr Hole	Grade	Max RPM	Qty/Case
<b>T29</b>				
638060-05906-7	4.5" x 7/8"	40+	13,300	10
638060-05907-4	4.5" x 7/8"	60+	13,300	10
638060-05908-1	4.5" x 7/8"	80+	13,300	10
638060-05925-8	4.5" x 7/8"	120+	13,300	10
638060-05916-6	5" x 7/8"	40+	12,000	10
638060-05917-3	5" x 7/8"	60+	12,000	10
638060-05920-3	5" x 7/8"	80+	12,000	10
638060-05929-6	5" x 7/8"	120+	12,000	10
638060-05912-8	7" x 7/8"	40+	8,600	5
638060-05913-5	7" x 7/8"	60+	8,600	5
638060-05914-2	7" x 7/8"	80+	8,600	5
638060-05927-2	7" x 7/8"	120+	8,600	5
<b>T29 Quick Change</b>				
638060-05937-1	4.5" x 5/8-11	40+	13,300	10
638060-05938-8	4.5" x 5/8-11	60+	13,300	10
638060-05939-5	4.5" x 5/8-11	80+	13,300	10
638060-05947-0	5" x 5/8-11	40+	12,000	10
638060-05948-7	5" x 5/8-11	60+	12,000	10
638060-05951-7	5" x 5/8-11	80+	12,000	10
638060-05943-2	7" x 5/8-11	40+	8,600	10
638060-05944-9	7" x 5/8-11	60+	8,600	10
638060-05945 6	7" x 5/8-11	80+	8,600	10

### Tech tip

For even faster cut and longer life, try 3M™ Cubitron™ II Flap Discs 967A and 969F.

### A word about wear.

The life and cut of a flap disc is determined by how quickly the backing wears away to expose new mineral. If it wears too quickly, it can significantly shorten the disc life. But if it doesn't wear properly, the disc might stop cutting altogether. The backing in 3M™ Flap Disc 769F is designed to wear just the right amount to provide consistent cut over a wide range of medium- and heavy-duty applications. The backing combined with the power of 3M Precision-Shaped Grain, helps 3M™ Flap Disc 769F outperform competition — at a value price!



## 3M™ Flap Discs

### 3M™ Flap Discs 577F

- Versatile alumina zirconia mineral works on a variety of metals and applications
- Durable YF wt polyester backing designed for long life on the most heavy duty grinding applications
- Giant flap disc is packed with 25% more abrasive material than standard flap disc – delivers longer life and fewer disc changes

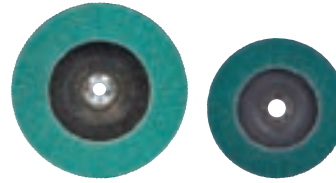

UPC	Dia x Ctr Hole	Grade	Max RPM	Qty/ Case
<b>T27</b>				
051141-30955-2	4-1/2" x 7/8"	36	13,300	10
051141-30956-9	4-1/2" x 7/8"	40	13,300	10
051141-30957-6	4-1/2" x 7/8"	60	13,300	10
051141-30958-3	4-1/2" x 7/8"	80	13,300	10
051141-30971-2	4-1/2" x 7/8" Giant	36	13,300	10
051141-30972-9	4-1/2" x 7/8" Giant	40	13,300	10
051141-30973-6	4-1/2" x 7/8" Giant	60	13,300	10
051141-30974-3	4-1/2" x 7/8" Giant	80	13,300	10
051141-30959-0	7" x 7/8"	36	8,600	5
051141-30960-6	7" x 7/8"	40	8,600	5
051141-30961-3	7" x 7/8"	60	8,600	5
051141-30975-0	7" x 7/8" Giant	36	8,600	5
051141-30976-7	7" x 7/8" Giant	40	8,600	5
051141-30977-4	7" x 7/8" Giant	60	8,600	5
<b>T27 Quick Change</b>				
051141-30951-4	4-1/2" x 5/8-11	36	13,300	10
051141-30952-1	4-1/2" x 5/8-11	40	13,300	10
051141-30953-8	4-1/2" x 5/8-11	60	13,300	10
051141-30954-5	4-1/2" x 5/8-11	80	13,300	10
051141-30967-5	4-1/2" x 5/8-11 Giant	36	13,300	10
051141-30968-2	4-1/2" x 5/8-11 Giant	40	13,300	10
051141-30969-9	4-1/2" x 5/8-11 Giant	60	13,300	10
051141-30970-5	4-1/2" x 5/8-11 Giant	80	13,300	10
051141-30963-7	7" x 5/8-11	36	8,600	5
051141-30964-4	7" x 5/8-11	40	8,600	5
051141-30965-1	7" x 5/8-11	60	8,600	5
051141-30966-8	7" x 5/8-11	80	8,600	5
051141-30979-8	7" x 5/8-11 Giant	36	8,600	5
051141-30980-4	7" x 5/8-11 Giant	40	8,600	5
051141-30981-1	7" x 5/8-11 Giant	60	8,600	5

UPC	Dia x Ctr Hole	Grade	Max RPM	Qty/ Case
<b>T29</b>				
051141-30987-3	4-1/2" x 7/8"	36	13,300	10
051141-30988-0	4-1/2" x 7/8"	40	13,300	10
051141-30989-7	4-1/2" x 7/8"	60	13,300	10
051141-30990-3	4-1/2" x 7/8"	80	13,300	10
051141-31003-9	4-1/2" x 7/8" Giant	36	13,300	10
051141-31004-6	4-1/2" x 7/8" Giant	40	13,300	10
051141-31005-3	4-1/2" x 7/8" Giant	60	13,300	10
051141-31006-0	4-1/2" x 7/8" Giant	80	13,300	10
051141-30995-8	7" x 7/8"	36	8,600	5
051141-30996-5	7" x 7/8"	40	8,600	5
051141-30997-2	7" x 7/8"	60	8,600	5
051141-30998-9	7" x 7/8"	80	8,600	5
051141-31007-7	7" x 7/8" Giant	36	8,600	5
051141-31008-4	7" x 7/8" Giant	40	8,600	5
<b>T29 Quick Change</b>				
051141-30983-5	4-1/2" x 5/8-11	36	13,300	10
051141-30984-2	4-1/2" x 5/8-11	40	13,300	10
051141-30985-9	4-1/2" x 5/8-11	60	13,300	10
051141-30986-6	4-1/2" x 5/8-11	80	13,300	10
051141-30999-6	4-1/2" x 5/8-11 Giant	36	13,300	10
051141-31000-8	4-1/2" x 5/8-11 Giant	40	13,300	10
051141-31001-5	4-1/2" x 5/8-11 Giant	60	13,300	10
051141-31002-2	4-1/2" x 5/8-11 Giant	80	13,300	10
051141-30991-0	7" x 5/8-11	36	8,600	5
051141-30992-7	7" x 5/8-11	40	8,600	5
051141-30993-4	7" x 5/8-11	60	8,600	5
051141-30994-1	7" x 5/8-11	80	8,600	5
051141-31011-4	7" x 5/8-11 Giant	36	8,600	5
051141-31012-1	7" x 5/8-11 Giant	40	8,600	5

**More material.  
Longer life.**

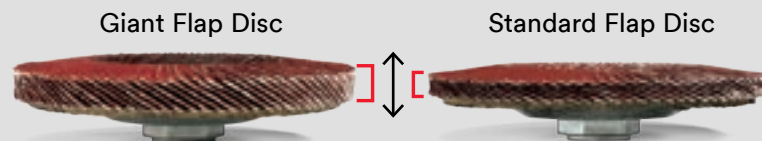

**Need more cutting power? Go GIANT!**

Our Giant flap discs are 25% thicker, for an aggressive cut with added durability and longer life.

# Scotch-Brite™ Discs

Make tough jobs easier. Scotch-Brite™ Discs can help you achieve a burr-free, paintable finish in fewer steps without damaging the base material. The non-woven, open web and durable construction is designed to resist loading and greatly increase the life of the disc. As a result, you will not have to change it as often. However, when you do change your disc, the Roloc™ attachment or Hook-and-Loop attachment makes it fast and easy.



## Choose the Right Disc for the Job Scotch-Brite™ Surface Conditioning Disc Guide

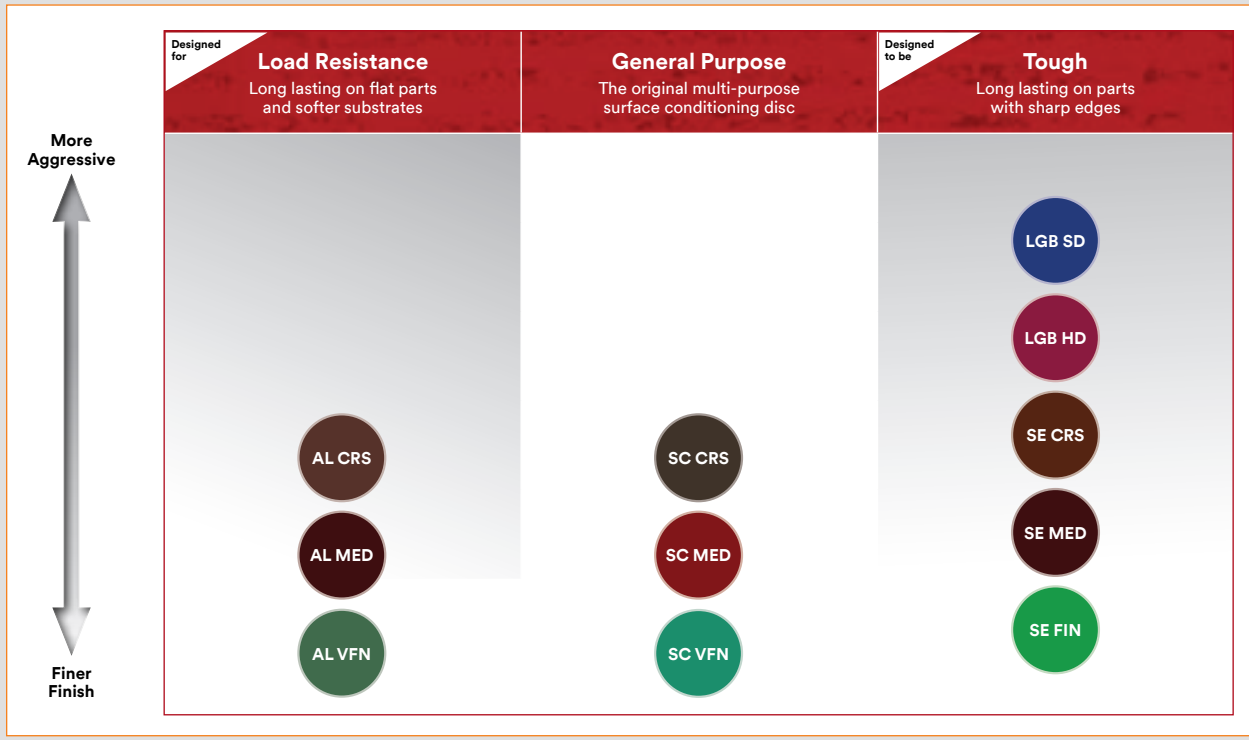

## Scotch-Brite™ Discs: Clean and Strip

### Scotch-Brite™ Clean and Strip XT Pro Discs

- Quickly removes rust, paint, mill scale and coatings from metal
- High-strength fiber resists chunking and performs well on edges
- High conformability provides a larger contact patch for faster removal rates
- Silicon carbide mineral cuts aggressively and leaves a fine finish



UPC	Dia x AH	Grade	Max RPM	Min/Case
<b>T27</b>				
638060-05586-1	4-1/2" x 7/8"	S XCS	13,300	10
638060-21661-3	6" x 1/2"	S XCS	4,000	15
638060-29938-8	7" x 3-1/8"	S XCS	3,600	15
638060-05587-8	7" x 7/8"	S XCS	8,600	5
<b>T27 Quick Change</b>				
638060-05574-8	4-1/2" x 5/8-11	S XCS	13,300	10
638060-29931-9	5" x 5/8-11	S XCS	12,000	10
076308-45481-4	7" x 5/8-11	S XCS	8,600	5
<b>TN Quick Change</b>				
638060-05588-5	4-1/2" x 5/8-11	S XCS	13,300	10
638060-05589-2	7" x 5/8-11	S XCS	8,600	5
<b>Roloc™ TR</b>				
638060-21538-8	2" x NH	S XCS	18,000	10/60
638060-21540-1	3" x NH	S XCS	15,000	10
638060-21541-8	3" x NH	S XCS	15,000	10/40
638060-21542-5	4" x NH	S XCS	11,000	10/40

### Scotch-Brite™ Clean and Strip XT Pro Extra Cut Discs

- Quickly removes heavy rust, thick paint, corrosion and cleans welds
- Aluminum oxide mineral aggressively removes top layer and cleans to the bare metal underneath
- High conformability provides a larger contact patch for faster removal rates
- High-strength fiber resists chunking and performs well on edges



UPC	Dia x AH	Grade	Max RPM	Min/Case
<b>T27</b>				
638060-21665-1	4" x 1/4"	A XCS	9,000	25
638060-21032-1	4-1/2" x 7/8"	A XCS	13,300	10
638060-21664-4	6" x 1/2"	A XCS	4,000	15
638060-29940-1	7" x 3-1/8"	A XCS	3,600	15
638060-21036-9	7" x 7/8"	A XCS	8,600	5
<b>T27 Quick Change</b>				
638060-21050-5	4-1/2" x 5/8-11	A XCS	13,300	10
638060-29936-4	5" x 5/8-11	A XCS	12,000	10
638060-21055-0	7" x 5/8-11	A XCS	8,600	5
<b>TN Quick Change</b>				
638060-21037-6	4-1/2" x 5/8-11	A XCS	13,300	10
638060-21039-0	7" x 5/8-11	A XCS	8,600	5
<b>Roloc™ TR</b>				
638060-21543-2	2" x NH	A XCS	18,000	10/60
638060-21544-9	3" x NH	A XCS	15,000	10
638060-21545-6	3" x NH	A XCS	15,000	10/40
638060-21546-3	4" x NH	A XCS	11,000	10/40

## Scotch-Brite™ Discs: Hook-and-Loop

### Scotch-Brite™ SC Surface Conditioning Discs: Hook-and-Loop

- Aluminum oxide
- Great general purpose surface conditioning disc
- For finishing, cleaning, and light deburring
- Attach and remove easily to 3M™ Hook-and-Loop Backup Pads
- Use with right angle and random orbital tools

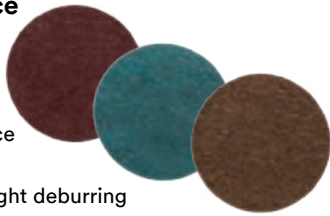

UPC	Dia x Ctr Hole	Grade	Color	Max RPM	Min/Case
<b>Hook-and-Loop</b>					
048011-04118-6	1-1/2"	A CRS	Brown	25,000	200
048011-04122-3	1-1/2"	A MED	Maroon	25,000	200
048011-04275-6	1-1/2"	A VFN	Blue	25,000	200
048011-07458-0	2"	A CRS	Brown	23,000	50/200
048011-07459-7	2"	A MED	Maroon	23,000	50/200
048011-04276-3	2"	A VFN	Blue	23,000	50/200
048011-04127-8†	2"	S SFN	Gray	23,000	50/200
048011-04120-9	3"	A CRS	Brown	20,000	25/100
048011-04124-7	3"	A MED	Maroon	20,000	100
048011-04277-0	3"	A VFN	Blue	20,000	100
048011-04128-5	3"	S SFN	Gray	20,000	100
048011-93148-7	3-1/2"	A MED	Maroon	13,000	100
048011-07450-4	4"	A CRS	Brown	13,000	100
048011-07451-1	4"	A MED	Maroon	13,000	25/100
048011-04278-7	4"	A VFN	Blue	13,000	100
048011-04129-2	4"	S SFN	Gray	13,000	100
048011-14101-5	4-1/2"	A CRS	Brown	13,000	50
048011-27671-7	4-1/2"	A CRS	Brown	13,000	10
048011-27672-4	4-1/2"	A MED	Maroon	13,000	10
048011-14100-8	4-1/2"	A MED	Maroon	13,000	50
048011-27673-1	4-1/2"	A VFN	Blue	13,000	10
048011-14099-5	4-1/2"	A VFN	Blue	13,000	50
048011-14102-2	4-1/2"	S SFN	Gray	13,000	50
048011-27674-8	5"	A CRS	Brown	10,000	10
048011-00750-2	5"	A CRS	Brown	10,000	50
048011-27675-5	5"	A MED	Maroon	10,000	10
048011-00643-7	5"	A MED	Maroon	10,000	50
048011-27676-2	5"	A VFN	Blue	10,000	10
048011-04303-6	5"	A VFN	Blue	10,000	50
048011-00647-5	5"	S SFN	Gray	10,000	50
048011-03927-5	6"	A CRS	Brown	8,000	50
048011-03928-2	6"	A MED	Maroon	8,000	50
048011-04304-3	6"	A VFN	Blue	8,000	50
048011-27677-9	7"	A CRS	Brown	6,000	10
048011-00751-9	7"	A CRS	Brown	6,000	25
048011-27678-6	7"	A MED	Maroon	6,000	10
048011-00645-1	7"	A MED	Maroon	6,000	25
048011-27679-3	7"	A VFN	Blue	6,000	10
048011-04305-0	7"	A VFN	Blue	6,000	25
048011-00648-2	7"	S SFN	Gray	6,000	25

†Made-to-Order

### Scotch-Brite™ SC Surface Conditioning Discs: Hook-and-Loop (cont)

UPC	Dia x Ctr Hole	Grade	Color	Max RPM	Min/Case
<b>Hook-and-Loop</b>					
048011-00752-6	8"	A CRS	Brown	6,000	25
048011-00670-3	8"	A MED	Maroon	6,000	25
048011-04306-7	8"	A VFN	Blue	6,000	25
048011-00649-9†	8"	S SFN	Gray	6,000	25
048011-93147-0	14"	A MED	Maroon	2,000	15
048011-93132-6	18"	A CRS	Brown	1,600	10
048011-16558-5	27"	A CRS	Brown	1,000	2
048011-16559-2	27"	A MED	Maroon	1,000	2
048011-16918-7	27"	A VFN	Blue	1,000	2
048011-05667-8	36"	A VFN	Blue	800	2
048011-13325-6†	48"	A CRS	Brown	600	2
048011-13100-9†	48"	A MED	Maroon	600	2
048011-13099-6†	48"	A VFN	Blue	600	2
048011-18385-5†	48"	S SFN	Gray	600	2
<b>TN Quick Change</b>					
048011-24244-6	4-1/2"	A CRS	Brown	13,000	50
048011-24247-7	4-1/2"	A MED	Maroon	13,000	50
048011-24250-7	4-1/2"	A VFN	Blue	12,000	50
048011-18000-7	5"	A VFN	Blue	9,500	50
048011-18001-4	5"	A MED	Maroon	9,500	50
048011-18002-1	5"	A CRS	Brown	9,500	50
048011-24254-5	5"	S SFN	Gray	9,500	50
048011-24246-0	7"	A CRS	Brown	7,000	25
048011-24249-1	7"	A MED	Maroon	7,000	25
048011-24252-1	7"	A VFN	Blue	7,000	25
<b>Center Hole</b>					
048011-18015-1	4" x 7/8"	A CRS	Brown	13,000	100
048011-60215-8	4-1/2" x 7/8"	A CRS	Brown	13,300	50
048011-93146-3	4-1/2" x 7/8"	A MED	Maroon	13,300	50
048011-16047-4	5" x 7/8"	A CRS	Brown	12,000	50
048011-00644-4	5" x 7/8"	A MED	Maroon	12,000	50
048011-18618-4	5" x 7/8"	A VFN	Blue	12,000	50
048011-18626-9	7" x 7/8"	A CRS	Brown	8,600	25
048011-18624-5	7" x 7/8"	A VFN	Blue	8,600	25
048011-93150-0	7-1/2" x 7/8"	A MED	Maroon	6,000	25
048011-93144-9	7-1/2" x 7/8"	A VFN	Blue	6,000	25
048011-93145-6	44" x 3"	A MED	Maroon	600	2
048011-93141-8	44" x 3"	A VFN	Blue	600	2

†Made-to-Order

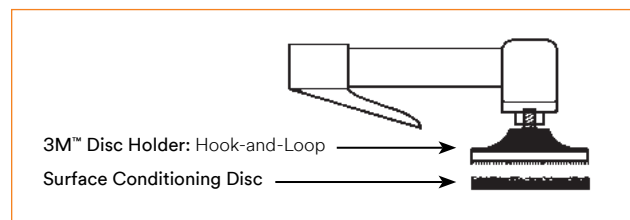

# Scotch-Brite™ Discs: Hook-and-Loop and Center Hole

## Scotch-Brite™ AL Surface Conditioning Discs

- Great for aluminum and other soft metal finishing
- Loading resistant and longer life
- Faster blending and finishing
- Better edge retention

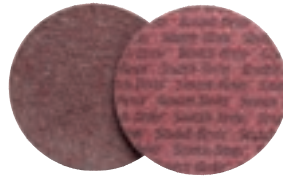

UPC	Dia	Grade	Color	Max RPM	Qty/Case
051141-54219-5	4-1/2"	A CRS	Brown	9,600	50
051141-54218-8	4-1/2"	A MED	Maroon	9,600	50
051141-54217-1	4-1/2"	A VFN	Blue	9,600	50
051141-54212-6	5"	A CRS	Brown	8,500	50
051141-54215-7	5"	A MED	Maroon	8,500	50
051141-54213-3	5"	A VFN	Blue	8,500	50
051141-54204-1	7"	A CRS	Brown	6,000	25
051141-54211-9	7"	A MED	Maroon	6,000	25
051141-54214-0	7"	A VFN	Blue	6,000	25

## Scotch-Brite™ SE Surface Conditioning Discs: Hook-and-Loop

- High cutting surface conditioning disc great for edge deburring applications



UPC	Diameter	Grade	Max RPM	Qty/Case
048011-18021-2	4"	A CRS	13,000	100
048011-18475-3†	4"	A MED	13,000	100
048011-18079-3	4-1/2"	A CRS	13,000	50
048011-18476-0	4-1/2"	A MED	13,000	50
048011-18080-9	5"	A CRS	10,000	50
048011-18919-2†	5"	A MED	10,000	50
048011-17866-0	7"	A CRS	6,000	25
048011-18477-7	7"	A MED	6,000	25
048011-30003-0†	7"	A FIN	6,000	25
048011-17239-2	8"	A CRS	6,000	25
048011-93348-1†	48"	A CRS	600	2

†Made-to-Order

## Scotch-Brite™ Light Grinding and Blending (LGB) Disc: Hook-and-Loop and Center Hole

- Durable, non-woven 3M ceramic aluminum oxide blend abrasive grain product used for light grinding applications providing burr-free finish
- For use with the 3M™ Center Pin Backup Pad or 3M™ Fibre Disc Hubs, Face Plates and Retainer Nuts
- Super Duty = Blue; Heavy Duty = Maroon



UPC	Dia x Ctr Hole	Grade	Max RPM	Min/Case
<b>Hook-and-Loop</b>				
048011-60335-3	4-1/2"	A CRS HD	10,000	50
048011-60342-1	5"	A CRS HD	10,000	50
048011-60345-2	7"	A CRS HD	6,000	25
<b>Center Hole</b>				
048011-60363-6	4-1/2"	A CRS SD	10,000	50
048011-60333-9†	4-1/2" x 7/8"	A CRS SD	10,000	50
048011-60332-2†	4-1/2" x 7/8"	A CRS HD	10,000	50
048011-60343-8	5"	A CRS SD	10,000	50
048011-60341-4	5" x 7/8"	A CRS SD	10,000	50
048011-60336-0	5" x 7/8"	A CRS HD	10,000	50
048011-60346-9	7"	A CRS SD	6,000	25
048011-60344-5	7" x 7/8"	A CRS SD	6,000	25
048011-60347-6	7" x 7/8"	A CRS HD	6,000	25

†Made-to-Order

## Scotch-Brite™ Light Grinding and Blending (LGB) Disc TN Quick Change

- 3M ceramic abrasive grain
- Aggressive, long life, consistent finish
- Resistant to edge wear
- Super Duty: Blue
- Heavy Duty: Maroon

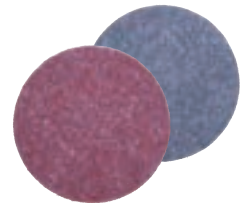

UPC	Dia x AH	Grade	Max RPM	Qty/Case
<b>TN Quick Change</b>				
048011-60349-0	4-1/2" x 5/8-11*	A CRS SD	13,000	50
048011-60348-3	4-1/2" x 5/8-11*	A CRS HD	13,000	50
048011-60351-3	5" x 5/8-11*	A CRS SD	12,000	50
048011-60350-6	5" x 5/8-11*	A CRS HD	12,000	50
048011-60353-7	7" x 5/8-11*	A CRS SD	8,600	25
048011-60352-0	7" x 5/8-11*	A CRS HD	8,600	25

# Right Angle Disc Systems

## Scotch-Brite™ Discs

### Scotch-Brite™ Coating Removal Discs: Hook-and-Loop

- Extra coarse grade silicon carbide
- Made for right-angle tools from aggressive Clean & Strip web
- Non-loading design ideal for removing rust and coatings
- Mount on Hook-and-Loop Disc Pad Holders



UPC	Diameter	Grade	Max RPM	Min/Case
<b>Hook-and-Loop</b>				
048011-18424-1	4-1/2"	S XCS	12,000	5/20
048011-18482-1*	4-1/2"	S XCS	12,000	40
048011-18355-8	5"	S XCS	10,000	5/20
048011-18483-8*	5"	S XCS	10,000	40
048011-18358-9	7"	S XCS	6,000	2/10
048011-18485-2*	7"	S XCS	6,000	20

\*Bulk

### Scotch-Brite™ Clean and Finish Discs: Hook-and-Loop

- Flexible web for finishing, blending and polishing
- Conformability allows access to hard-to-reach areas



UPC	Diameter	Grade	Max RPM	Qty/Case
048011-16001-6	5"	A VFN	5,000	100
048011-00661-1	6"	A VFN	4,000	100
048011-30037-5	11-1/4"	A VFN	1,900	25

### Scotch-Brite™ HS Blend & Finish Discs

- Flexible and aggressive
- Tackles weld burn and refinement, light deburring and rust removal
- Produces a beautifully blended, burr-free finish



UPC	Dia x Ctr Hole	Grade	Max RPM	Qty/Case
048011-64145-4	6" x 1/2"	A MED	4,000	100
048011-64169-0	8" x 1/2"	A MED	3,000	50
048011-64183-6	12" x 1-1/4"	A MED	1,900	25

### Scotch-Brite™ EXL Unitized Discs

- High performance and durability for deburring and finishing applications
- A layered, durable unitized disc construction



UPC	Dia x Ctr Hole	Grade	Max RPM	Qty/Case
<b>T27</b>				
048011-29201-4	4-1/2" x 7/8"	2S FIN	11,000	5
048011-27689-2	4-1/2" x 7/8"	6S FIN	13,300	5
048011-29200-7	4-1/2" x 7/8"	8A CRS	13,300	5

### Scotch-Brite™ Deburr & Finish PRO Unitized Disc

- High performance and durability for deburring and finishing applications
- A layered, durable unitized disc construction



UPC	Dia x Ctr Hole	Grade	Density	Max RPM	Qty/Case
<b>T27</b>					
076308-77122-5	4-1/2" x 7/8"	MED+	6C	12,100	5
076308-77200-0	4-1/2" x 7/8"	CRS+	8C	12,100	5

### Scotch-Brite™ Bristle Discs

- Easily remove paint, stains, adhesives, weld burn, rust and other surface contaminants from large areas

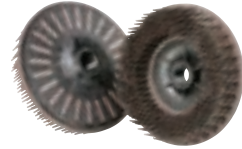

UPC	Diameter x AH	Grade	Color	Max RPM	Qty/Case
048011-33054-9	4-1/2" x 5/8-11 INT	36	Brown	12,000	10
048011-24241-5	4-1/2" x 5/8-11 INT	50	Green	12,000	10
048011-24242-2	4-1/2" x 5/8-11 INT	80	Yellow	12,000	10
048011-24243-9	4-1/2" x 5/8-11 INT	120	White	12,000	10

## 3M™ Power Tools: Right Angle Disc Systems

### 3M™ Disc Sanders

- 3M™ Gripping Material for reduced vibration and a secure grip with less effort
- Easy-handling, compact design for less vibration



UPC	Model	Tool Diameter Inch (mm)	Motor HP (W)	Max RPM	Air Flow Rate SCFM (LPM)	Noise Level dBA (power)	Weight Pound (kg)	Length Inch (mm)	Height Inch (mm)	Air Inlet Thread	Collet Size
051141-28408-8	28408	4-5 (100-127)	1 (744)	12,000	37 (1,048)	84 (95)	3.1 (1.4)	8 (210)	4 (107)	3/8" NPT	1/4"
051141-28825-3	28825	4-1/2-5 (114.3-127)	1.5 (1,120)	12,000	40 (1,133)	90 (82)	4.9 (2.2)	11 (279)	4 (102)	1/2" NPT	1/4"

### 3M™ Grinders – T27

- Heavy duty gear heads for added durability under high force applications
- 3M™ Gripping Material for reduced vibration and a secure grip with less effort
- Repositionable steel guards for better visibility



UPC	Model	Tool Dia Inch (mm)	Motor HP (W)	Max RPM	Air Flow Rate SCFM (LPM)	Noise Level dBA (power)	Weight Pound (kg)	Length Inch (mm)	Height Inch (mm)	Air Inlet Thread	Thread Size
051141-28403-3	28403	4 (100)	1 (744)	12,000	37 (1,048)	86 (98)	3.5 (1.6)	9 (216)	5 (114)	3/8" NPT	3/8-24 EXT
051141-28405-7	28405	4-1/2 (114.3)	1 (744)	12,000	37 (1,048)	85 (99)	3.7 (1.7)	9 (216)	5 (119)	3/8" NPT	5/8-11 EXT
051141-28824-6	28824	4-1/2-5 (114.3-127)	1.5 (1,120)	12,000	40 (1,133)	84 (92)	5.3 (2.4)	11 (279)	4 (105)	1/2" NPT	5/8-11 EXT

### 3M™ Cut-Off Wheel Tools

- Easily cuts through everything from standard rebar to oversized bolts
- Exclusive 3M™ Gripping Material for added comfort
- Model 28826 provides greater versatility and control with right angle head and easily repositionable guard



UPC	Model	Tool Dia Inch (mm)	Motor HP (W)	Max RPM	Air Flow Rate SCFM (LPM)	Noise Level dBA (power)	Weight Pound (kg)	Length Inch (mm)	Height Inch (mm)	Air Inlet Thread
051141-20233-4	20233	3 (76)	1 (744)	25,000	37 (1,048)	91 (102)	2.6 (1.2)	8 (197)	3 (76)	3/8" NPT
051141-28771-3	28771	4 (100)	1 (744)	19,000	37 (1,048)	90 (102)	2.7 (1.2)	8 (197)	3 (83)	3/8" NPT
051141-28826-0	28826	4-1/2-5 (115-125)	1.5 (1,120)	12,000	40 (1,133)	84 (92)	5.5 (2.5)	11 (279)	4 (111)	1/2" NPT

# Accessories: Right Angle Disc Systems

Product	UPC	For Use With	Size (Inch)/Description	Max RPM	Qty/Case
<b>Flap Disc Adapter Nut</b>					
	051144-88765-1	Secures 4-1/2" diameter flap discs to right angle tool with a 5/8-11 threaded shaft	5/8-11 Thread	N/A	1 Pair/ 5 Pairs
<b>Flap Disc/Grinding Wheel Adapter Kit</b>					
	051144-88769-9	Mounting kit for 6" and larger flap discs/grinding wheels	4 Diameter; 5/8-11 Thread	N/A	1
<b>3M™ Hook-and-Loop Disc Pad Holders</b>					
	051141-20245-7	Scotch-Brite™ Light Grinding and Blending Disc Accessories	7 x 7/8 Center Post; 5/8-11 INT	8,500	1
922/923 	048011-07494-8	Scotch-Brite™ Surface Conditioning Discs	2 (1/4" shank); Cat. 922	23,000	10
	048011-04132-2	Scotch-Brite™ Surface Conditioning Discs	3 (1/4" shank); Cat. 923	20,000	10
924 	048011-07492-4	Scotch-Brite™ Surface Conditioning Discs	4 (1/4 shank); Cat. 924	13,000	5
914 	048011-05674-6	Scotch-Brite™ Surface Conditioning Discs	4 x 1/8 x 3/8; 5/8-11 INT; Cat. 914	13,000	1
9145/915 	048011-14111-4	Scotch-Brite™ Surface Conditioning Discs	4-1/2 x 5/8-11 INT; Cat. 9145	13,000	1
	048011-05680-7	Scotch-Brite™ Surface Conditioning Discs	5 x 5/8-11 INT; Cat. 915	13,000	1
917 	048011-09450-2	Scotch-Brite™ Surface Conditioning Discs	7" x 5/8-11 INT; Cat. 917	6,000	1
947TH 	051141-20279-2	Scotch-Brite™ Surface Conditioning Discs	7 x 1 x 5/8-11 INT; Cat. 947TH	6,000	1
918 	048011-09451-9	Scotch-Brite™ Surface Conditioning Discs	8 x 5/16 x 3/8; 5/8-11 INT; Cat. 918	6,000	1
28892/28891/ 28890 	051141-28892-5	Scotch-Brite™ Surface Conditioning Discs with 7/8" diameter center holes	4" x 7/8" CP; 5/8-11 INT	15,000	10
	051141-28891-8	Scotch-Brite™ Surface Conditioning Discs with 7/8" diameter center holes	4-1/2" x 7/8" CP; 5/8-11 INT	12,000	10
	051141-28890-1	Scotch-Brite™ Surface Conditioning Discs with 7/8" diameter center holes	5" x 7/8" CP; 5/8-11 INT	12,000	10
<b>3M™ Hookit™ Disc Pad</b>					
	051144-85096-9	Scotch-Brite™ Coating Removal Discs	5 x 5/8 x 5/8-11 INT	12,000	5
	051144-85105-8	Scotch-Brite™ Coating Removal Discs	5 x 3/4 x 5/8-11 INT	12,000	5
	051144-13627-8	Scotch-Brite™ Coating Removal Discs	7 x 1 x 5/8-11 INT	6,000	1
<b>3M Stikit™ Disc Pads</b>					
	051144-05579-1	3M™ Stikit™ Discs	8 x 5/8-11 INT	3,000	1
	051111-55813-3	3M™ Stikit™ Discs	5 x 1/2 x 5/8-11 INT	12,000	5
<b>3M™ Disc Pad Hub</b>					
	051141-28442-2	Short shaft tools (for tools with 3/8-24 INT spool)	2-1/2 Diameter; 3/8-24 metal insert	N/A	10
	051144-45205-7	3M™ Disc Pad Face Plates (all sizes)	2-1/2 Diameter; 5/8-11 metal insert	N/A	10
	051144-88743-9	3M™ Disc Pad Face Plates (short shaft electric grinders)	2-1/2 Diameter; 5/8-11 metal insert	N/A	10
	051144-11824-3	3M™ Disc Pad Face Plates (all sizes; GL quick change)	2-1/2 Diameter; 5/8-11 metal insert	N/A	1
	051144-11823-6	3M™ Disc Pad Face Plates (7"-9"; GL quick change)	4-1/2 Diameter; 5/8-11 metal insert	N/A	1
	051144-45190-6	3M™ Disc Pad Face Plates (7"-9"; GL quick change)	4-1/2 Diameter; 5/8-11 metal insert	N/A	10

\*CP = CenterPost, for use with 7/8" center hole Scotch-Brite™ Discs

Chart continued on next page

## Accessories: Right Angle Disc Systems

Product	UPC	For Use With	Size/Description	Max RPM	Qty/Case
<b>3M™ Low Profile Disc Pad Hub</b>					
	051141-28476-7	3M™ Disc Pad Face Plates (all sizes, tool shaft length 5/8" or more)	2-1/2" Diameter; 5/8–11 metal insert	N/A	10
<b>3M™ Disc Pad Face Plates</b>					
	051144-13325-3	Fibre Discs	4-1/2" Diameter; Smooth; Medium – Gray	13,300	10
	051144-14270-5	Fibre Discs	4-1/2" Diameter; Smooth; Hard – Black	13,300	10
	051141-28443-9	Fibre Discs	4-1/2" Diameter; Ribbed; Extra Hard – Red	13,300	10
	051144-81734-4	Fibre Discs	5" Diameter; Ribbed; Medium – Gray	12,000	10
	051144-81733-7	Fibre Discs	5" Diameter; Ribbed; Hard – Black	12,000	10
	051144-81732-0	Fibre Discs	5" Diameter; Ribbed; Extra Hard – Red	12,000	10
	051144-80516-7	Fibre Discs	7" Diameter; Ribbed; Medium – Gray	8,600	10
	051144-80515-0	Fibre Discs	7" Diameter; Ribbed; Hard – Black	8,600	10
	051144-80514-3	Fibre Discs	7" Diameter; Ribbed; Extra Hard – Red	8,600	10
	051144-81729-0	Fibre Discs	9" Diameter; Ribbed; Hard – Black	6,600	10
051144-81728-3	Fibre Discs	9" Diameter; Ribbed; Extra Hard – Red	6,600	10	
<b>3M™ TN Quick Change Disc Backup Pad</b>					
	051111-56573-5	4-1/2" TN Discs	4-1/2" x 5/8–11 INT	13,300	5
<b>3M™ Disc Retainer Nuts</b>					
	051111-51047-6	3M™ Disc Pad Face Plates and Disc Pad Hubs	5/16" Depth; 5/8–11 Thread	N/A	10
	051144-05620-0		5/8" Depth; 5/8–11 Thread	N/A	10
	051144-05622-4		3/8" Depth; 5/8–11 Thread	N/A	10
	051144-05621-7		1/2"; Depth; 5/8–11 Thread	N/A	10
<b>3M™ Disc Holder Adapter 9</b>					
	048011-22971-3	Converts grinders with M10–1.25, M10–1.5 or 3/8–24 EXT threaded shaft to a 5/8–11 EXT threaded shaft	M10–1.25 INT	N/A	10
	048011-22972-0		M10–1.50 INT	N/A	10
	048011-22970-6		3/8–24 INT	N/A	10
<b>For Bonded Wheels and Cut-Off Wheels</b>					
<b>Grinding Wheel Adapter Nut</b>					
	051144-88765-1	Secures 4-1/2" diameter grinding wheels to right angle tool with a 5/8–11 threaded shaft	5/8–11 Thread	N/A	1 Pair/ 5 Pairs
<b>Flap Disc/Grinding Wheel Adapter Kit</b>					
	051144-88769-9	Mounting kit for 6" and larger flap discs/grinding wheels	4" Diameter; 5/8–11 Thread	N/A	1
<b>3M™ Green Corps™ Flexible Grinding Disc</b>					
	051111-51046-9	Holder for 4-1/2" x 7/8" center hole flexible grinding wheel	3-3/8" Diameter; 7/8" Center Hole; Clear	N/A	5/100
	051111-51045-2	Holder for 7" x 7/8" center hole flexible grinding wheel	4-5/8" Diameter; 7/8" Center Hole; Clear	N/A	5/100
<b>Flange Nut</b>					
	051141-28739-3	4" grinder with 3/8–24 thread; 4" x 1/4" x 5/8" center hole Depressed Center Grinding Wheels and Unitized Wheels	1" x 5/8" x 3/8"; 3/8–24 INT	N/A	1 set/bag, 5 sets/case
	051141-28740-9	4-1/2" grinder with 5/8–11 thread; 4" x 1/4" x 5/8" center hole Depressed Center Grinding Wheels and Unitized Wheels	1" x 5/8"; 5/8–11 INT	N/A	1 set/bag, 5 sets/case

# 3M™ Roloc™ Systems

## 3M™ Roloc™ Discs

3M™ Roloc™ Discs provide a fast, efficient method for grinding, blending, leveling and finishing on all types of metal. They lock securely in place with just a half twist... another half twist and they're off. Each disc is color coded by grade. (This does not include 3M™ Roloc™ TSM products.)

### 3M™ Roloc™ Cloth Disc Selection Guide



Product	Mineral Type	Features	Metal Type	Perform.	Grinding	Light Grinding	Blending	Deburring
984F	Precision-Shaped Grain	Durable 2-ply backing; Grinding aid; Fastest cutting	All Metals	Premium	●	●	●	●
947A	Precision-Shaped Grain	Durable 2-ply backing; Grinding aid	Stainless Steel and Aluminum	Premium	●	●	●	●
361F	Aluminum Oxide	Durable YF wt Polyester backing; General purpose grinding, light grinding, blending and deburring on all metals	All Metals	Good	●	●	●	●

### 3M™ Roloc™ Fibre Disc Selection Guide

Product	Mineral Type	Features	Metal Type	Perform.	Grinding	Light Grinding	Blending	Deburring
982C	Precision-Shaped Grain	Fastest cutting; Longest life	Carbon Steel	Premium	●	●		●
987C	Precision-Shaped Grain	Best in class performance; Grinding aid	Stainless Steel	Premium	●	●		●
787C	Precision-Shaped Grain	Grinding aid	Stainless Steel and Aluminum	Advanced	●	●		●
782C	Precision-Shaped Grain	Performance and value	Carbon Steel	Advanced	●	●		●

# 3M™ Roloc™ Discs

## 3M™ Roloc™ Attachment System Guide

Product ID	Attachment Type			Diameter	Attachment Type		
	TR	TSM	TS		TR	TSM	TS
361F	●	●		1"	●	●	●
777F	●	●	●	1-1/2"	●	●	●
947A	●	●		2"	●	●	●
984F	●	●		3"	●	●	●
782C	●	●		4"	●		●
787C	●	●		TR (Plastic Button) 			
982C	●	●		TSM (Metal Button) 			
987C	●	●		TS (Plastic Button) 			

## 3M™ Roloc™ Disc Button Color/Grade Chart

- 24/Black
- 80/Yellow
- 150/Black
- 36/Brown
- 100/Blue
- 180/Brown
- 50/Green
- 120/White
- 240/Green
- 60/Orange



## Optimum Tool Speeds to Maximize 3M™ Roloc™ Disc Cut Rates and Life

Disc Size	Material			
	Stainless	Aluminum	Steel	Titanium
1-1/2"	20,000 RPM	30,000 RPM	30,000 RPM	9,000 RPM
2"	15,000 RPM	20,000 RPM	20,000 RPM	7,000 RPM
3"	10,000 RPM	15,000 RPM	15,000 RPM	4,500 RPM
4"	8,000 RPM	9,000 RPM	9,000 RPM	3,000 RPM

## 3M™ Cubitron™ II Roloc™ Fibre Disc 982C ■

- Made with revolutionary 3M precision-shaped grain technology
- Provides long life and fast cut
- Rigid fiber backing enables fast, more aggressive cutting
- Optimized for use on carbon steel



UPC	Diameter	Grade	Min/Case
<b>Roloc™ TR (Plastic Button)</b> 			
051115-66778-7	2"	36+	50/200
051115-66783-1	2"	60+	50/200
051115-66788-6	2"	80+	50/200
051115-66779-4	3"	36+	50/200
051115-66784-8	3"	60+	50/200
051115-66789-3	3"	80+	50/200
051115-66780-0	4"	36+	25/100
051115-66785-5	4"	60+	25/100
051115-66790-9	4"	80+	25/100
<b>Roloc™ TSM (Metal Button)</b> 			
051115-66781-7	2"	36+	50/200
051115-66786-2	2"	60+	50/200
051115-66791-6	2"	80+	50/200
051115-66782-4	3"	36+	50/200
051115-66787-9	3"	60+	50/200
051115-66792-3	3"	80+	50/200
<b>Roloc™ TS (Plastic Button)</b> 			
051125-86755-9	4"	36+	25/100
051125-86760-3	4"	60+	25/100
051125-86761-0	4"	80+	25/100

■ Mild Steel ■ Stainless Steel

## 3M Precision-Shaped Grain

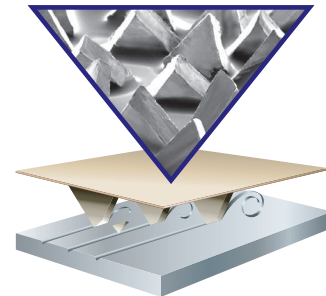

3M precision-shaped grain uses 3M microreplication technology to form sharp peaks that easily “slice” through metal — cutting cooler, faster and lasting longer than conventional abrasive grain.

**3M**  
**CUBITRON™ II**  
 Industrial Abrasives

# 3M™ Roloc™ Discs

## 3M™ Cubitron™ II Fibre Disc 987C ■

- 3M precision-shaped grain, engineered with ultra-sharp, fast cutting points that wear evenly, run cool, and optimize mineral breakdown to maximize life
- Best in class for weld prep and removal on heat sensitive alloys such as stainless steel



UPC	Size	Grade	Qty
<b>Roloc™ TR (Plastic Button)</b>			
051125-94952-1	2"	36+	50/200
051125-94957-6	2"	60+	50/200
051125-94962-0	2"	80+	50/200
051125-94953-8	3"	36+	50/200
051125-94958-3	3"	60+	50/200
051125-94963-7	3"	80+	50/200
051125-94954-5	4"	36+	25/100
051125-94959-0	4"	60+	25/100
051125-94964-4	4"	80+	25/100
<b>Roloc™ TSM (Metal Button)</b>			
051125-94955-2	2"	36+	50/200
051125-94960-6	2"	60+	50/200
051125-94965-1	2"	80+	50/200
051125-94956-9	3"	36+	50/200
051125-94961-3	3"	60+	50/200
051125-94966-8	3"	80+	50/200
<b>Roloc™ TS (Plastic Button)</b>			
051125-87217-1	4"	36+	25/100
051125-87218-8	4"	60+	25/100
051125-87219-5	4"	80+	25/100

## 3M™ Cubitron™ II Roloc™ Durable Edge Disc 947A ■■

- Features 3M precision-shaped grain
- Great for deburring, blending, cleaning, and finishing applications
- Loading resistant resulting resistant resulting in a faster cut and longer lasting
- Quick-change capability



UPC	Diameter	Grade	Max RPM	Min/Case
<b>Roloc™ TR (Plastic Button)</b>				
051141-54239-3	1-1/2"	40+	30,000	50/200
051141-54255-3	1-1/2"	80+	30,000	50/200
051141-54247-8	1-1/2"	60+	30,000	50/200
051141-54263-8	1-1/2"	120+	30,000	50/200
051141-54240-9	2"	40+	25,000	50/200
051141-54248-5	2"	60+	25,000	50/200
051141-54256-0	2"	80+	25,000	50/200
051141-54264-5	2"	120+	25,000	50/200
051141-54241-6	3"	40+	20,000	50/200
051141-54249-2	3"	60+	20,000	50/200
051141-54257-7	3"	80+	20,000	50/200
051141-54265-2	3"	120+	20,000	50/200

■ Mild Steel ■ Stainless Steel

## 3M™ Cubitron™ II Roloc™ Durable Edge Disc 947A (cont)

UPC	Diameter	Grade	Max RPM	Min/Case
<b>Roloc™ TR (Plastic Button)</b>				
051141-54242-3	4"	40+	12,000	25/100
051141-54250-8	4"	60+	12,000	25/100
051141-54258-4	4"	80+	12,000	25/100
051141-54266-9	4"	120+	12,000	25/100
<b>Roloc™ TSM (Metal Button)</b>				
051141-54243-0	1-1/2"	40+	30,000	50/200
051141-54251-5	1-1/2"	60+	30,000	50/200
051141-54259-1	1-1/2"	80+	30,000	50/200
051141-54267-6	1-1/2"	120+	30,000	50/200
051141-54244-7	2"	40+	25,000	50/200
051141-54252-2	2"	60+	25,000	50/200
051141-54260-7	2"	80+	25,000	50/200
051141-54268-3	2"	120+	25,000	50/200
051141-54245-4	3"	40+	20,000	50/200
051141-54253-9	3"	60+	20,000	50/200
051141-54261-4	3"	80+	20,000	50/200
051141-54269-0	3"	120+	20,000	50/200
051141-54246-1	4"	40+	12,000	25/100
051141-54254-6	4"	60+	12,000	25/100
051141-54262-1	4"	80+	12,000	25/100
051141-54270-6	4"	120+	12,000	25/100

## 3M™ Cubitron™ II Roloc™ Durable Edge Disc 984F ■■

- Made with revolutionary 3M precision-shaped grain technology
- Features a durable edge backing and a grinding aid
- For grinding, blending and deburring of light to medium pressure applications for virtually all metal types



UPC	Diameter	Grade	Max RPM	Min/Case
<b>Roloc™ TR (Plastic Button)</b>				
051141-27700-4	1-1/2"	36+	30,000	50/200
051141-27708-0	1-1/2"	60+	30,000	50/200
051141-27716-5	1-1/2"	80+	30,000	50/200
051141-27701-1	2"	36+	25,000	50/200
051141-27709-7	2"	60+	25,000	50/200
051141-27717-2	2"	80+	25,000	50/200
051141-27702-8	3"	36+	20,000	50/200
051141-27710-3	3"	60+	20,000	50/200
051141-28218-3†	3"	80+	20,000	50/200
051141-27703-5	4"	36+	12,000	25/100
051141-27711-0	4"	60+	12,000	25/100
051141-27719-6	4"	80+	12,000	25/100
<b>Roloc™ TSM (Metal Button)</b>				
051141-27704-2	1-1/2"	36+	30,000	50/200
051141-27712-7	1-1/2"	60+	30,000	50/200
051141-27720-2	1-1/2"	80+	30,000	50/200
051141-27705-9	2"	36+	25,000	50/200
051141-27713-4	2"	60+	25,000	50/200
051141-27721-9	2"	80+	25,000	50/200

# 3M™ Roloc™ Discs

## 3M™ Cubitron™ II Roloc™ Durable Edge Disc 984F (cont)



UPC	Diameter	Grade	Max RPM	Min/Case
<b>Roloc™ TSM (Metal Button)</b> 				
051141-27706-6	3"	36+	20,000	50/200
051141-27714-1	3"	60+	20,000	50/200
051141-27707-3	4"	36+	12,000	25/100
051141-27715-8	4"	60+	12,000	25/100
051141-27723-3	4"	80+	12,000	25/100

†Made-to-Order

## 3M™ Fibre Disc 782C ■ for Carbon Steel

- Ideal choice for carbon steel
- Offer a faster cut and longer life than alumina zirconia (AZ) and conventional ceramic abrasives
- These discs require less grinding pressure for easier operation



UPC	Diameter	Grade	Qty/Case
<b>Roloc™ TR (Plastic Button)</b> 			
076308-89665-2	2"	36+	50/200
076308-89670-6	2"	60+	50/200
076308-89675-1	2"	80+	50/200
076308-89666-9	3"	36+	50/200
076308-89671-3	3"	60+	50/200
076308-89676-8	3"	80+	50/200
076308-89667-6	4"	36+	25/100
076308-89672-0	4"	60+	25/100
076308-89677-5	4"	80+	25/100
<b>Roloc™ TS (Plastic Button)</b> 			
076308-89685-0	4"	36+	25/100
076308-89686-7	4"	60+	25/100
076308-89687-4	4"	80+	25/100

## 3M™ Fibre Disc 787C ■ for stainless steel non-ferrous metals



- Optimized for stainless steel and non-ferrous metals like aluminum and titanium
- Cuts cooler, faster and lasts longer than alumina zirconia (AZ) and conventional ceramic discs in applications like weld removal, beveling, edge chamfering and more
- Made with 3M Precision-Shaped Grain, for outstanding speed and long life
- Great for grinding, weld removal, beveling and edge chamfering



UPC	Size	Grade	Qty
<b>Roloc™ TR (Plastic Button)</b> 			
076308-89689-8	2"	36+	50/200
076308-89694-2	2"	60+	50/200
076308-89699-7	2"	80+	50/200
076308-89704-8	2"	120+	50/200
076308-89690-4	3"	36+	50/200
076308-89695-9	3"	60+	50/200
076308-89700-0	3"	80+	50/200
076308-89705-5	3"	120+	50/200

■ Mild Steel ■ Stainless Steel

## 3M™ Fibre Disc 787C (cont)

UPC	Size	Grade	Qty
<b>Roloc™ TR (Plastic Button)</b> 			
076308-89691-1	4"	36+	25/100
076308-89696-6	4"	60+	25/100
076308-89701-7	4"	80+	25/100
076308-89706-2	4"	120+	25/100
<b>Roloc™ TS (Plastic Button)</b> 			
076308-89709-3	4"	36+	25/100
076308-89710-9	4"	60+	25/100
076308-89711-6	4"	80+	25/100
076308-89712-3	4"	120+	25/100

## 3M™ Roloc™ Disc 361F ■

- Aluminum oxide on a YF wt cloth backing
- General purpose grinding, blending and finishing on all metals



UPC	Diameter	Grade	Max RPM	Min/Case
<b>Roloc™ TR (Plastic Button)</b> 				
051144-11412-2	1"	36	30,000	50/500
051144-11411-5	1"	50	30,000	50/500
051144-11417-7	1"	60	30,000	50/500
051144-11416-0	1"	80	30,000	50/500
051144-11415-3	1"	P100	30,000	50/500
051144-11414-6	1"	P120	30,000	50/500
051144-11452-8†	1-1/2"	24	30,000	50/500
051144-22396-1	1-1/2"	36	30,000	50/500
051144-11137-4	1-1/2"	50	30,000	50/500
051144-22397-8	1-1/2"	60	30,000	50/500
051144-22407-4	1-1/2"	80	30,000	50/500
051144-22408-1	1-1/2"	P100	30,000	50/500
051144-22409-8	1-1/2"	P120	30,000	50/500
051144-11000-1	2"	24	25,000	50/200
051144-22398-5	2"	36	25,000	50/200
051144-22399-2	2"	50	25,000	50/200
051144-22400-5	2"	60	25,000	50/200
051144-22401-2	2"	80	25,000	50/200
051144-22402-9	2"	P100	25,000	50/200
051144-22403-6	2"	P120	25,000	50/200
051144-14559-1	2"	P150	25,000	50/200
051144-13873-9	2"	P180	25,000	50/200
051144-11419-1	2"	P240	25,000	50/200
051144-22392-3	3"	24	20,000	50/200
051144-22393-0	3"	36	20,000	50/200
051144-22394-7	3"	50	20,000	50/200
051144-22395-4	3"	60	20,000	50/200
051144-22404-3	3"	80	20,000	50/200
051144-22405-0	3"	P100	20,000	50/200
051144-22406-7	3"	P120	20,000	50/200
051144-82244-7	3"	P150	20,000	50/200
051144-11418-4	3"	P240	20,000	50/200
051144-76429-7	4"	36	12,000	25/100
051144-11421-4	4"	60	12,000	25/100
051144-11420-7	4"	80	12,000	25/100

†Made-to-Order

Chart continued on next page

# 3M™ Roloc™ Discs

## 3M™ Roloc™ Disc 361F (cont)

UPC	Diameter	Grade	Max RPM	Min/Case
<b>Roloc™ TSM (Metal Button)</b> 				
051111-49932-0	1-1/2"	36	30,000	50/500
051144-49933-7	1-1/2"	60	30,000	50/500
051144-49934-4	1-1/2"	80	30,000	50/500
051144-51039-1	1-1/2"	P100	30,000	50/500
051144-51038-4†	1-1/2"	P120	30,000	50/500
051144-49936-8	2"	36	25,000	50/200
051144-49937-5	2"	60	25,000	50/200
051144-49938-2	2"	80	25,000	50/200
051144-51034-6	2"	P100	25,000	50/200
051144-49939-9	2"	P120	25,000	50/200
051144-51033-9	3"	36	20,000	50/200
051144-49940-5	3"	60	20,000	50/200
051144-49941-2	3"	80	20,000	50/200
051144-49942-9	3"	P100	20,000	50/200
051144-49943-6	3"	P120	20,000	50/200



†Made-to-Order



## 3M™ Roloc™ Disc 777F ■

- 3M ceramic aluminum oxide blend abrasive grain
- Cloth backing for durability
- Grinding aid for cooler running



UPC	Diameter	Grade	Max RPM	Min/Case
<b>Roloc™ TR (Plastic Button)</b> 				
051144-76622-2	1"	36	30,000	50/500
051144-76623-9	1"	50	30,000	50/500
051144-76624-6	1"	60	30,000	50/500
051144-76625-3	1"	80	30,000	50/500
051144-80510-5	1"	P120	30,000	50/500
051144-76626-0	1-1/2"	36	30,000	50/500
051144-76627-7	1-1/2"	50	30,000	50/500
051144-76628-4	1-1/2"	60	30,000	50/500
051144-14660-4	1-1/2"	80	30,000	50/500
051144-80511-2	1-1/2"	P120	30,000	50/500
051144-76629-1	2"	36	25,000	50/200
051144-76630-7	2"	50	25,000	50/200
051144-76433-4	2"	60	25,000	50/200
051144-14661-1	2"	80	25,000	50/200
051144-80508-2	2"	P100	25,000	50/200
051144-80512-9	2"	P120	25,000	50/200
051144-76631-4	3"	36	20,000	50/200
051144-76632-1	3"	50	20,000	50/200
051144-76633-8	3"	60	20,000	50/200
051144-76634-5	3"	80	20,000	50/200
051144-80509-9	3"	P100	20,000	50/200
051144-80513-6	3"	P120	20,000	50/200
<b>Roloc™ TSM (Metal Button)</b> 				
051111-49949-8	2"	36	25,000	50/200
051111-50253-2	2"	60	25,000	50/200
051111-50254-9	2"	80	25,000	50/200
051111-50255-6	2"	100	25,000	50/200
051111-50256-3	2"	P120	25,000	50/200
051111-50257-0	3"	36	20,000	50/200
<b>Roloc™ TS (Plastic Button)</b> 				
051144-76742-7	2"	36	25,000	50/200
051144-76746-5	2"	50	25,000	50/200
051144-76750-2	2"	60	25,000	50/200
051144-76743-4†	3"	36	20,000	50/200
051144-76747-2†	3"	50	20,000	50/200
051144-76751-9	3"	60	20,000	50/200
051144-76755-7	3"	80	20,000	50/200

†Made-to-Order

■ Mild Steel ■ Stainless Steel

**Choose the Right Disc for the Job**  
 Scotch-Brite™ Surface Conditioning Disc Guide

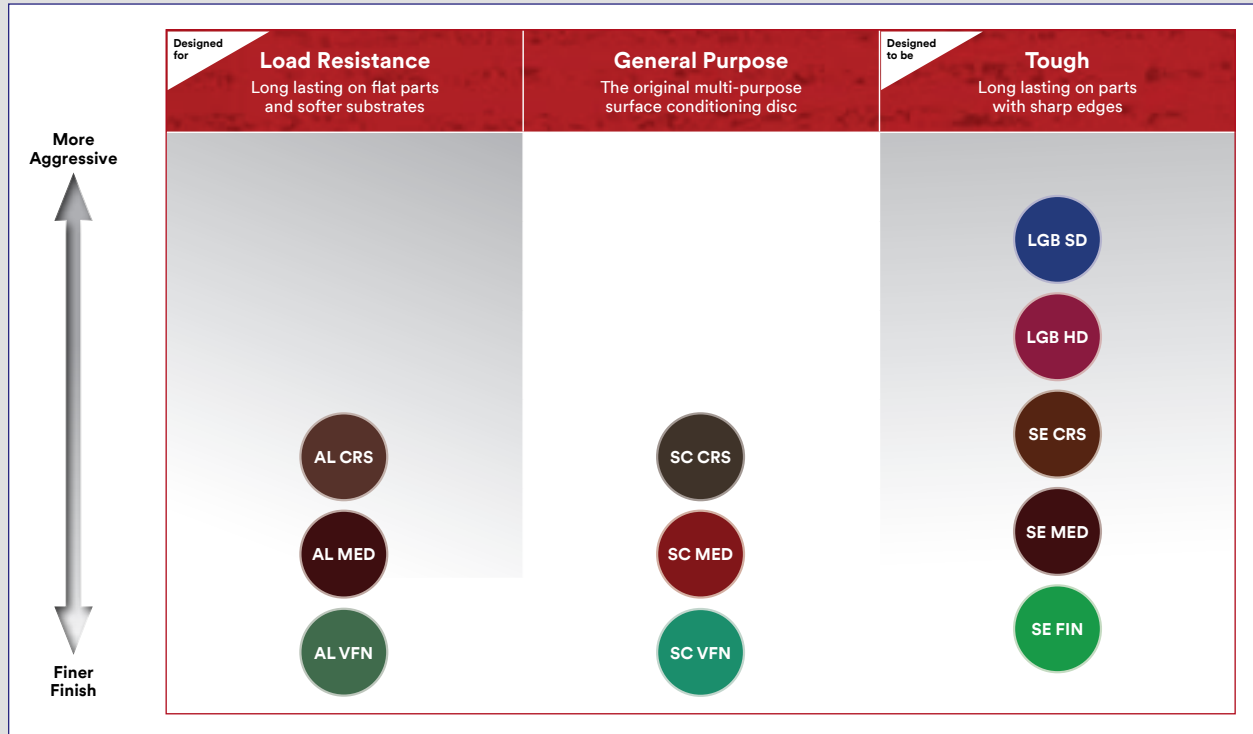

3M™ Roloc™ Systems

## Scotch-Brite™ Roloc™ Discs

### Scotch-Brite™ Roloc™ AL Surface Conditioning Discs

- Great for aluminum and other soft metal finishing
- Loading Resistant and longer life
- Faster blending and finishing
- Better edge



UPC	Size	Grade	Max RPM	Discs
<b>Roloc™ TSM (Metal Button)</b>				
051141-54149-5	1-1/2" x NH	A CRS	30,000	200/cs
051141-54148-8	1-1/2" x NH	A MED	30,000	200/cs
051141-54147-1	1-1/2" x NH	A VFN	30,000	200/cs
051141-54143-3	2" x NH	A CRS	25,000	50/200
051141-54142-6	2" x NH	A MED	30,000	50/200
051141-54146-4	2" x NH	A VFN	25,000	50/200
051141-54145-7	3" x NH	A CRS	18,000	25/100
051141-54144-0	3" x NH	A MED	18,000	25/100

†Made-to-Order

UPC	Size	Grade	Max RPM	Discs
<b>Roloc™ TR (Plastic Button)</b>				
051141-54141-9†	3/4" x NH	A CRS	30,000	200/cs
051141-54125-9	1" x NH	A CRS	30,000	200/cs
051141-54124-2	1" x NH	A MED	30,000	200/cs
051141-54123-5	1" x NH	A VFN	30,000	200/cs
051141-54108-2	1-1/2" x NH	A CRS	30,000	200/cs
051141-54109-9	1-1/2" x NH	A MED	30,000	200/cs
051141-54110-5	1-1/2" x NH	A VFN	30,000	200/cs
051141-54137-2	2" x NH	A CRS	25,000	50/200
051141-54136-5	2" x NH	A MED	25,000	50/200
051141-54135-8	2" x NH	A VFN	25,000	50/200
051141-54140-2	3" x NH	A CRS	18,000	25/100
051141-54139-6	3" x NH	A MED	18,000	25/100
051141-54138-9	3" x NH	A VFN	18,000	25/100
051141-54113-6	4" x NH	A CRS	12,000	25/100
051141-54112-9	4" x NH	A MED	12,000	25/100

†Made-to-Order

■ Mild Steel ■ Stainless Steel

# Scotch-Brite™ Roloc™ Discs

## Scotch-Brite™ Roloc™ AL Surface Conditioning (cont)

UPC	Size	Grade	Max RPM	Discs
<b>TN Quick Change</b>				
076308-64361-4	4-1/2" x 5/8-11	A CRS	12,000	50/cs
076308-64363-8	4-1/2" x 5/8-11	A MED	12,000	50/cs
076308-64365-2	4-1/2" x 5/8-11	A VFN	12,000	50/cs
076308-64360-7	5" x 5/8-11	A CRS	9,500	50/cs
076308-64359-1	5" x 5/8-11	A MED	9,500	50/cs
076308-64362-1	7" x 5/8-11	A CRS	7,000	25/cs

### Roloc™ TS (Plastic Button)

051141-54114-3	2" x NH	A CRS	25,000	50/200
051141-54115-0	2" x NH	A MED	25,000	50/200
051141-54116-7	2" x NH	A VFN	25,000	50/200
051141-54117-4	3" x NH	A CRS	18,000	25/100
051141-54118-1	3" x NH	A MED	18,000	25/100
051141-54119-8	3" x NH	A VFN	18,000	25/100
051141-54150-1	3" x NH	A VFN	18,000	25/100
051141-54120-4	4" x NH	A CRS	12,000	25/100
051141-54121-1	4" x NH	A MED	12,000	25/100

†Made-to-Order

## Scotch-Brite™ Roloc™ SE Surface Conditioning Discs

- This coarse, tough, aggressive non-woven disc is ideal for heavy-duty deburring and finishing



UPC	Diameter	Grade	Max RPM	Min/Case
<b>Roloc™ TR (Plastic Button)</b>				
048011-18081-6	2"	A CRS	25,000	50/200
048011-18471-5	2"	A MED	25,000	50/200
048011-30005-4	2"	A FIN	25,000	50/200
048011-18082-3	3"	A CRS	18,000	25/100
048011-18472-2	3"	A MED	18,000	25/100
048011-93453-2	3"	A FIN	18,000	25/100

## Scotch-Brite™ Roloc™ SC Surface Conditioning Discs

- Scotch-Brite surface conditioning non-woven web provides a burr-free decorative finish



- Removes grind marks, rust and coatings
- Grade: A VFN – Blue; A MED – Maroon; A CRS – Brown

UPC	Diameter	Grade	Max RPM	Min/Case
<b>Roloc™ TR (Plastic Button)</b>				

048011-15393-3	1"	A CRS	30,000	200
048011-15392-6	1"	A MED	30,000	200
048011-15391-9	1"	A VFN	30,000	200
048011-15568-5†	1"	A SFN	30,000	200
048011-08764-1	1-1/2"	A CRS	30,000	50/200
048011-08765-8	1-1/2"	A MED	30,000	50/200
048011-08766-5	1-1/2"	A VFN	30,000	50/200
048011-08767-2†	1-1/2"	A SFN	30,000	50/200
048011-05528-2	2"	A CRS	25,000	50/200
048011-05527-5	2"	A MED	25,000	50/200
048011-05522-0	2"	A SFN	25,000	50/200
048011-05523-7	2"	A VFN	25,000	50/200
048011-05532-9	3"	A CRS	18,000	25/100
048011-05531-2	3"	A MED	18,000	25/100
048011-05529-9	3"	A SFN	18,000	25/100
048011-05530-5	3"	A VFN	18,000	25/100
048011-12954-9	4"	A CRS	12,000	25/100
048011-12953-2	4"	A MED	12,000	25/100
048011-12951-8†	4"	A SFN	12,000	25/100
048011-12952-5	4"	A VFN	12,000	25/100

### Roloc™ TSM (Metal Button)

048011-13249-5†	1-1/2"	A CRS	30,000	50/200
048011-25775-4	1-1/2"	A CRS	30,000	50/200
048011-25774-7†	1-1/2"	A MED	30,000	50/200
048011-25773-0†	1-1/2"	A VFN	30,000	50/200
048011-25765-5	2"	A CRS	25,000	50/200
048011-25764-8	2"	A MED	25,000	50/200
048011-25770-9	2"	A VFN	25,000	50/200
048011-25767-9	3"	A CRS	18,000	25/100
048011-25766-2	3"	A MED	18,000	25/100
048011-25780-8	3"	A VFN	18,000	25/100
048011-13260-0†	3"	A SFN	18,000	25/100

### Roloc™ TS (Metal Button)

048011-13257-0	3"	A CRS	18,000	25/100
048011-13258-7	3"	A MED	18,000	25/100
048011-13259-4	3"	A VFN	18,000	25/100



†Made-to-Order

## Scotch-Brite™ Roloc™ Discs

### Scotch-Brite™ Roloc™ Light Grinding and Blending (LGB) Discs

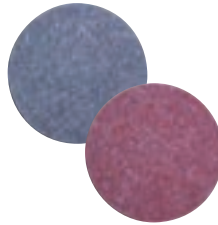
- 3M ceramic aluminum oxide blend abrasive grain
- Resists edge wear
- Great for light grinding, deburring and blending on all metals
- Super Duty: Blue
- Heavy Duty: Maroon



UPC	Diameter	Grade	Max RPM	Qty/Case
<b>Roloc™ TR (Plastic Button)</b> 				
048011-60355-1	2"	A CRS SD	25,000	50/200
048011-60354-4	2"	A CRS HD	25,000	50/200
048011-60357-5	3"	A CRS SD	18,000	25/100
048011-60356-8	3"	A CRS HD	18,000	25/100
048011-60359-9	4"	A CRS SD	12,000	25/100
048011-60358-2	4"	A CRS HD	12,000	25/100
<b>Roloc™ TSM (Metal Button)</b> 				
048011-60375-9	2"	A CRS SD	25,000	50/200
048011-60374-2	2"	A CRS HD	25,000	50/200
048011-60377-3	3"	A CRS SD	18,000	25/100
048011-60376-6+	3"	A CRS HD	18,000	25/100

\*Made-to-Order

### Scotch-Brite™ Roloc™ Clean and Strip Discs

- Aggressively removes paint, rust and seam sealers
- Open web construction for cool running and resistance to loading and smearing
- Faster cutting than wire brushes and wheels to increase production





UPC	Size	Grade	Max RPM	Qty/Case
048011-14784-0	4" x 1"	S XCS	8,000	10
048011-14780-2	4" x 1" x 1/4"	S XCS	8,000	10

### Scotch-Brite™ Roloc™ HS Blend and Finish

- Aluminum oxide mineral
- New high strength nonwoven with superior durability and cut
- Great flexibility and conformability for weld burn removal, light deburring, blending, finishing and rust removal



UPC	Diameter	Grade	Max RPM	Min/Case
<b>Roloc™ TR (Plastic Button)</b> 				
048011-64190-4	2"	A MED	18,000	200
048011-64206-2	3"	A MED	15,000	100
<b>Roloc™ TSM (Metal Button)</b> 				
048011-64213-0	2"	A MED	18,000	200
048011-64220-8	3"	A MED	15,000	100

### Scotch-Brite™ Roloc™ Bristle Discs

- Efficiently cleans and strips many substances from metal strip surfaces without damaging the work piece
- An operator can quickly and easily achieve a quality, consistent finish with light pressure



UPC	Size	Grade	Color	Max RPM	Min/Case
<b>Roloc™ TR (Plastic Button)</b> 					
048011-18698-6	1"	50	Green	30,000	80
048011-18706-8	1"	80	Yellow	30,000	80
048011-18710-5	1"	120	White	30,000	20/80
048011-18730-3	2"	50	Green	25,000	10/40
048011-18732-7	2"	80	Yellow	25,000	10/40
048011-18733-4	2"	120	White	25,000	10/40
048011-18734-1	3"	50	Green	15,000	10/40
048011-18736-5	3"	80	Yellow	15,000	10/40
048011-18737-2	3"	120	White	15,000	10/40

### Scotch-Brite™ Roloc™ Body Man's Bristle Disc

- Contains 3M ceramic aluminum oxide blend abrasive grain
- Removes high loading materials fast and doesn't load
- Great for removing rubberized undercoating, seam sealer, rust and paint
- Maintains high quality product life



UPC	Diameter	Grade	Max RPM	Min/Case
051131-07540-5	1"	36	30,000	6/36
051131-07536-8	2"	36	25,000	4/24
051131-07537-5	3"	36	18,000	3/18

# Scotch-Brite™ Roloc™ Discs

## Scotch-Brite™ Roloc™+ Clean and Strip XT Pro Discs

- Quickly removes rust, paint, mill scale and coatings from metal
- High-strength fiber resists chunking and performs well on edges
- High conformability provides a larger contact patch for faster removal rates
- Silicon carbide mineral cuts aggressively and leaves a fine finish



UPC	Dia x Ctr Hole	Grade	Max RPM	Min/Case
<b>Roloc™ TR (Plastic Button)</b>				
638060-21538-8	2" x NH	S XCS	18,000	10/60
638060-21540-1	3" x NH	S XCS	15,000	10
638060-21541-8	3" x NH	S XCS	15,000	10/40
638060-21542-5	4" x NH	S XCS	11,000	10/40
<b>Roloc™ TR+ (Plastic Button)</b>				
638060-21552-4	4" x 1/2"	S XCS	12,000	10
638060-21549-4	4" x 1"	S XCS	8,000	10

## Scotch-Brite™ Roloc™+ Clean and Strip XT Pro Extra Cut Discs

- Quickly removes heavy rust, thick paint, corrosion and cleans welds
- Aluminum oxide mineral aggressively removes top layer and cleans to the bare metal underneath
- High conformability provides a larger contact patch for faster removal rates
- High-strength fiber resists chunking and performs well on edges



UPC	Dia x Ctr Hole	Grade	Max RPM	Min/Case
<b>Roloc™ TR (Plastic Button)</b>				
638060-21543-2	2" x NH	A XCS	18,000	10/60
638060-21544-9	3" x NH	A XCS	15,000	10
638060-21545-6	3" x NH	A XCS	15,000	10/40
638060-21546-3	4" x NH	A XCS	11,000	10/40

## Scotch-Brite™ Roloc™ EXL Unitized Wheels

- Strong, efficient products for edge deburring and finishing
- Used with 3M™ Roloc™ or 3M™ Roloc™+ holder pads on a straight shaft or right-angle tool



UPC	Diameter	Grade	Max RPM	Min/Case
<b>Roloc™ TR (Plastic Button)</b>				
048011-17185-2	2"	2A MED	22,100	15/60
048011-17183-8	2"	2S FIN	22,100	15/60
048011-17190-6	2"	6A MED	22,100	15/60
048011-17192-0	2"	8A MED	22,100	15/60
048011-17186-9	3"	2A MED	15,100	10/40
048011-17184-5	3"	2S FIN	15,100	10/40
048011-17191-3	3"	6A MED	15,100	10/40
048011-17193-7	3"	8A MED	15,100	10/40

## Scotch-Brite™ Roloc™ Rapid Cut Unitized Wheels

- Non-woven abrasive wheels utilizing 3M precision-shaped ceramic grain for higher levels of cut while maintaining a consistent finish
- Recommended for deburring and weld blending on all metals
- Quick change Roloc™ attachment



UPC	Size	Grade	Max RPM	Min/Case
<b>Roloc™ TR (Plastic Button)</b>				
051115-66759-6	2" x NH	9C CRS+	22,100	15/60
048011-64859-0	3" x NH	9C CRS+	15,100	10/40
051115-66760-2	3" x NH	9C XCS+	15,100	10/40
<b>Roloc™ TS (Plastic Button)</b>				
051115-66763-3†	2" x NH	9C CRS+	22,100	15/60
051115-66764-0†	3" x NH	9C XCS+	15,100	10/40

†Made-to-Order

# Scotch-Brite™ Roloc™ Discs

## Scotch-Brite™ Roloc™ TR Deburr & Finish PRO

- Ideal for both OE use and for maintenance operations
- Soft to reduce defects, yet wear like iron, for fewer wheel changeouts
- Faster burr removal
- Better finish



UPC	Size (Dia x Thk x Ctr Hole)	Den	Grade	Max. RPM	Qty/ Case
<b>Roloc™ TR (Plastic Button)</b>					
076308-77231-4	2" x 1/4" x NH	2S	FIN	22,100	60
076308-77233-8	3" x 1/4" x NH	2S	FIN	15,100	40
076308-77115-7	2" x 1/4" x NH	4C	MED+	22,100	60
048011-65081-4	2" x 1/8" x NH	6C	MED+	22,100	120
048011-65082-1	2" x 1/4" x NH	6C	MED+	22,100	60
076308-77116-4	3" x 1/4" x NH	4C	MED+	15,100	40
048011-65084-5	3" x 1/8" x NH	6C	MED+	15,100	40
048011-65083-8	3" x 1/4" x NH	6C	MED+	15,100	40
076308-77198-0	2" x 1/4" x NH	8C	CRS+	22,100	60
076308-77197-3	3" x 1/8" x NH	8C	CRS+	15,100	40
076308-77199-7	3" x 1/4" x NH	8C	CRS+	15,100	40
<b>Unitized Disc</b>					
076308-77235-2	4-1/2" x 7/8"	2S	FIN	11,000	5
076308-77122-5	4-1/2" x 7/8"	6C	MED+	12,100	5
076308-77200-0	4-1/2" x 7/8"	8C	CRS+	12,100	5

## Scotch-Brite™ Roloc™ TR Deburr & Finish PRO (cont)

UPC	Size (Dia x Thk x Ctr Hole)	Den	Grade	Max. RPM	Qty/ Case
<b>Unitized Wheel</b>					
638060-05164-1	1" x 1" x 3/16"	2S	FIN	30,100	50
638060-05165-8	2" x 1/4" x 1/4"	2S	FIN	16,100	60
638060-05166-5	2" x 1/2" x 1/4"	2S	FIN	16,100	30
638060-05167-2	2" x 3/4" x 1/4"	2S	FIN	16,100	20
638060-05161-0	3" x 1/4" x 1/4"	2S	FIN	12,100	40
638060-05163-4	3" x 1/2" x 1/4"	2S	FIN	10,000	20
638060-05171-9	3" x 1/2" x 3/8"	2S	FIN	10,000	20
638060-05168-9	3" x 3/4" x 1/4"	2S	FIN	10,000	20
638060-05162-7	3" x 1" x 1/4"	2S	FIN	10,000	10
638060-05170-2	6" x 1/2" x 1"	2S	FIN	5,000	4
638060-05169-6	6" x 1" x 1"	2S	FIN	5,000	2
048011-65017-3	1" x 1" x 3/16"	6C	MED+	35,100	50
048011-65057-9	2" x 1/8" x 1/4"	6C	MED+	22,100	60
048011-65018-0	2" x 1/4" x 1/4"	6C	MED+	22,100	60
048011-65019-7	2" x 1/2" x 1/4"	6C	MED+	22,100	30
048011-65020-3	2" x 3/4" x 1/4"	6C	MED+	22,100	20
048011-65058-6	2" x 1" x 1/4"	6C	MED+	22,100	10
048011-65021-0	3" x 1/8" x 1/4"	6C	MED+	18,100	40
076308-77111-9	3" x 1/4" x 1/4"	4C	MED+	18,100	40
048011-65004-3	3" x 1/4" x 1/4"	6C	MED+	18,100	40
076308-77110-2	3" x 1/2" x 1/4"	4C	MED+	18,100	20
048011-65007-4	3" x 1/2" x 1/4"	6C	MED+	18,100	20
048011-65022-7	3" x 3/4" x 1/4"	6C	MED+	15,100	20
048011-65005-0	3" x 1" x 1/4"	6C	MED+	15,100	10
076308-77103-4	4" x 1" x 1/4"	6C	MED+	12,100	5
076308-90123-3	1" x 1" x 3/16"	8C	CRS+	35,100	50
076308-90129-5	2" x 1/8" x 1/4"	8C	CRS+	22,100	60
076308-90124-0	2" x 1/4" x 1/4"	8C	CRS+	22,100	60
076308-90125-7	2" x 1/2" x 1/4"	8C	CRS+	22,100	30
076308-90126-4	2" x 3/4" x 1/4"	8C	CRS+	22,100	20
076308-90127-1	3" x 1/8" x 1/4"	8C	CRS+	18,100	40
076308-90120-2	3" x 1/4" x 1/4"	8C	CRS+	18,100	40
076308-90122-6	3" x 1/2" x 1/4"	8C	CRS+	18,100	20
076308-90132-5	3" x 1/2" x 3/8"	8C	CRS+	18,100	20
076308-90128-8	3" x 3/4" x 1/4"	8C	CRS+	15,100	20
076308-90131-8	6" x 1/2" x 1"	8C	CRS+	7,500	4

## 3M™ Roloc™ Disc Packs

### 3M™ Roloc™ Disc Intro Pack 9815S, 982S and 983S

- Contains the following assortment of 3M's top selling Roloc™ Discs:
  - 3M™ Cubitron™ II Roloc™ Durable Edge Disc 984F (3 of each grade: 36+, 60+, 80+)
  - Scotch-Brite™ Roloc™ SC Surface Conditioning Disc (2 of each grade: A VFN, A MED, A CRS)
  - Scotch-Brite™ Roloc™ Light Grinding and Blending Disc (2 of each grade: SD ACRS)
- Contains 1 each of the following:
  - 3M™ Roloc™ Disc Pad TR (Hard)
  - 3M™ Roloc™ Shank



UPC	Part	Size	Min/Case
051144-82901-9	9815S	1-1/2"	5 packs/case
051144-82899-9	982S	2"	5 packs/case
051144-82900-2	983S	3"	5 packs/case

### 3M™ Roloc™ Disc Intro Pack 984S

- Contains the following assortment of 3M's top selling Roloc™ Discs:
  - 3M™ Cubitron™ II Roloc™ Durable Edge Disc 984F (3 of each grade: 36+, 60+, 80+)
  - Scotch-Brite™ Roloc™ SC Surface Conditioning Disc (2 of each grade: A VFN, A MED, A CRS)
  - Scotch-Brite™ Roloc™ Light Grinding and Blending Disc (2 of each grade: SD A CRS)
- Contains 1 each of the following:
  - 3M™ Roloc™ Disc Pad TR (Extra Hard)
  - 3M™ Spacer (PN28636)



UPC	Part	Size	Min/Case
051141-28039-4	984S	4"	5 packs/case

### Scotch-Brite™ Roloc™ AL Surface Conditioning Disc TR Multipack

- Cleans, finishes, blends and deburrs a variety of substrates, including ferrous and non-ferrous metals
- Strikes the perfect balance between strength and softness
- 1 of each A CRS, A MED, A VFN



UPC	Size	Min/Case
076308-77152-2	2"	10/case
076308-77153-9	3"	10/case

### 3M™ Roloc™ Disc Intro Pack 985S

- Contains the following assortment of 3M's top selling Roloc™ Discs:
  - 2" Scotch-Brite™ Roloc™ SC Surface Conditioning Disc (2 of each grade: A VFN, A MED, A CRS)
  - 3" Scotch-Brite™ Roloc™ SC Surface Conditioning Disc (2 of each grade: A VFN, A MED, A CRS)
  - 2" Scotch-Brite™ Roloc™ Light Grinding and Blending Disc (2 of each grade: SD ACRS)
  - 3" Scotch-Brite™ Roloc™ Light Grinding and Blending Disc (2 of each grade: SD ACRS)
- Contains 1 each of the following:
  - 3M™ Roloc™ Disc Pad 2" and 3" (Hard)
  - 3M™ Roloc™ Shank



UPC	Part	Size	Min/Case
048011-18254-4	985S	2" and 3"	5 packs/case

### 3M™ Roloc™ Bristle Disc Pack 983BS

- Contains a variety of grades of 3M™ Roloc™ Bristle Discs 3" diameter x 5/8" trim
- Includes a disc pad holder



UPC	Size	Min/Case
048011-18697-9	3"	1/5

### Scotch-Brite™ Roloc™ Unitized Wheel Pack 987S

- Roloc™ EXL Unitized Wheel
- 1 each 2A MED, 1 each 2S FIN, 1 each 6A MED, 1 each 6S FIN, 1 each 8A MED, 1 each 8A CRS, Roloc™ + Holder: 1 each



UPC	Size	Min/Case
048011-17181-4	2"	5/case

### Scotch-Brite™ Roloc™ Unitized Wheel 988S

- Roloc™ EXL Unitized Wheel
- 1 each 2A MED, 1 each 2S FIN, 1 each 6A MED, 1 each 6S FIN, 1 each 8A MED, 1 each 8A CRS, Roloc™ + Holder: 1 each



UPC	Size	Min/Case
048011-17182-1	3"	5/case

## 3M™ Power Tools: 3M™ Roloc™ Systems

### 3M™ Disc Sanders

- 3M™ Gripping Material for reduced vibration and a secure grip with less effort
- 97° head for decreased wrist strain
- Easy-handling, compact design for less vibration
- 3M™ Roloc™ Disc Pads can directly mount to sander without collet
- 1/4" collet included with all 2" and 3" disc sanders



28329/20231



28328/28341

UPC	Model	Tool Dia Inch (mm)	Motor HP (W)	Max RPM	Noise Level dBA (power)	Weight Pound (kg)	Length Inch (mm)	Height Inch (mm)	Air Inlet Thread	Airflow Rate SCFM (LPM)	Collet Size
051141-28341-8	28341	2 (51)	0.3 (224)	20,000	81 (92)	1.1 (0.5)	6 (150)	3 (63)	1/4" NPT	17 (481)	1/4"
051141-28328-9	28328	2-3 (51-76)	0.3 (224)	12,000	81 (92)	1.1 (0.5)	7 (172)	3 (64)	1/4" NPT	17 (481)	1/4"
051141-20231-0	20231	2 (51)	0.5 (372)	20,000	89 (101)	1.3 (0.6)	7 (172)	3 (70)	1/4" NPT	26 (736)	1/4"
051141-28329-6	28329	2-3 (51-76)	0.5 (372)	12,000	89 (101)	1.3 (0.6)	7 (172)	3 (70)	1/4" NPT	26 (736)	1/4"
051141-20232-7	20232	2-3 (51-76)	1 (744)	15,000	84 (95)	2.0 (0.9)	8 (210)	3 (83)	3/8" NPT	37 (1,048)	1/4"

### 3M™ Pistol Grip Disc Sander

- Lightweight, low cost alternative for customers who need a tool for spot duty or intermittent use
- Excellent balance and generates less noise and vibration than other disc sanders
- Durable composite body for ergonomic feel
- Dual mount feature allows user to switch between direct mount (for maximum control) and collet mount (for extended reach); 1/4" collet included



UPC	Model	PSI	Tool Dia Inch (mm)	Orbit Dia Inch (mm)	Motor HP (W)	Max RPM	Noise Level dBA (power)	Weight Pound (kg)	Length Inch (mm)	Height Inch (mm)	Airflow Rate SCFM (LPM)	Thread Size
051141-28547-4	28547	90	3 (76)	Rotary	0.45 (336)	15,000	74 (85)	1.8 (0.8)	5 (122)	5 (136)	23 (651)	1/4-20 EXT

### 3M™ Pistol Grip Random Orbital Disc Sander











- Primarily intended for sanding in the automotive market
- Powerful, lightweight tool with excellent balance
- Durable composite body for ergonomic feel
- Pistol grip design allows you to sand in hard-to-reach areas with ease



UPC	Model	PSI	Tool Dia Inch (mm)	Orbit Dia Inch (mm)	Motor HP (W)	Max RPM	Noise Level dBA (power)	Weight Pound (kg)	Length Inch (mm)	Height Inch (mm)	Airflow Rate SCFM (LPM)	Thread Size
051141-28353-1	28353*	90	3 (76)	1/8 (3)	0.45 (336)	15,000	75 (82)	1.8 (0.8)	5 (122)	5 (136)	22 (623)	5/16-24 EXT

\*Replacement Pad PN20427

# Accessories: 3M™ Roloc™ Systems

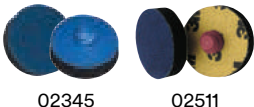
Product	UPC	For Use With	Size/Description	Max RPM	Qty/Case
<b>3M™ Roloc™ TR Disc Pads</b> 	051144-45101-2	3M™ Roloc™ TR Discs 	1" Diameter; Medium; 1/4–20 INT	30,000	5
	051144-45099-2		1-1/2" Diameter; Medium; 1/4–20 INT	30,000	5
	051144-45100-5		1-1/2" Diameter; Hard; 1/4–20 INT	30,000	5
	051144-45095-4		2" Diameter; Medium; 1/4–20 INT	25,000	5
	051144-45096-1		2" Diameter; Hard; 1/4–20 INT	25,000	5
	051144-45097-8		2" Diameter; Extra Hard; 1/4–20 INT	25,000	5
	051144-45092-3		3" Diameter; Medium; 1/4–20 INT	18,000	5
	051144-45091-6		3" Diameter; Hard; 1/4–20 INT	20,000	5
	051144-45093-0		3" Diameter; Extra Hard; 1/4–20 INT	20,000	5
	051144-45179-1		4" Diameter; Medium; 1/4–20 INT	12,000	5
	051141-28474-3		4" Diameter; Hard; 3/8–24 INT	12,000	5
	051141-28475-0		4" Diameter; Extra Hard; 3/8–24 INT	12,000	5
	051144-83242-2		4" Diameter; Medium; 5/8–11 INT	12,000	5
	051144-83489-1		4" Diameter; Hard; 5/8–11 INT	12,000	5
	051144-83980-3		4" Diameter; Extra Hard; 5/8–11 INT	12,000	5
<b>3M™ Roloc™ Cool Running Disc Pads</b> 	051144-82974-3	3M™ Roloc™ TR Discs 	2" Diameter; Medium; 1/4–20 INT	20,000	5
	051141-28711-9		2" Diameter; Hard; 1/4–20 INT	20,000	5
	051144-82975-0		3" Diameter; Medium; 1/4–20 INT	12,000	5
	051141-28710-2		3" Diameter; Hard; 1/4–20 INT	12,000	5
	051111-56479-0		4" Diameter; Hard; 3/8–24 INT	15,000	5
051141-28473-6	4" Diameter; Hard; 5/8–11 INT	15,000	5		
<b>3M™ Roloc™ TS or TSM Disc Pads</b> 	051144-77729-7	3M™ Roloc™ TSM Discs and "Screw on" Abrasive Discs 	1-1/2" Diameter; Medium; 1/4–20 INT	30,000	5
	051144-77728-0		1-1/2" Diameter; Hard; 1/4–20 INT	30,000	5
	051144-14211-8		2" Diameter; Medium; 1/4–20 INT	25,000	5
	051144-14212-5		2" Diameter; Hard; 1/4–20 INT	25,000	5
	051144-14215-6		3" Diameter; Medium; 1/4–20 INT	18,000	5
	051144-14216-3		3" Diameter; Hard; 1/4–20 INT	20,000	5
051141-28578-8	4" Diameter; Hard; 5/8–11 INT	12,000	5		
<b>1/4" Threaded Shaft</b> 	051144-45102-9	3M™ Roloc™ Disc Pads with 1/4–20 INT	1/4" x 1/4–20 Thread	N/A	10/50
<b>3M™ Roloc™ + Holder</b> 	048011-15408-4	3M™ Roloc™ Unitized Wheels, Roloc™+ Products, Brush and Disc Accessories	1" Diameter x 1/4" Shaft Diameter	25,000	5
<b>3M™ Vacuum Hose Anti-Static</b> 	051141-28730-0	Used to Connect Random Orbital and Orbital Sanders to a Vacuum System	1" ID x 4 ft Length, 1" EXT Hose Thread	N/A	1
<b>3M™ Overhose Kit</b> 	051141-28651-8	0.3 HP Die Grinders	<b>Kit Contains:</b> Air Line Extension (PN 20209), Adapter (PN 20453), Over Hose Cloth Sleeve, Exhaust Spacer, Air Inlet Bushing, Instruction Sheet	N/A	1
<b>Mini Sander</b>					
<b>3M™ Finesse-it™ Roloc™ Sanding Pads TR</b>  02345      02511	051111-50198-6	Roloc™ Disc Pad or with Tools Equipped with Roloc™ Attachment System	1-1/4" Diameter; Medium	10,000	20
	051111-51150-3		1-1/4" Diameter; Firm	10,000	20

# Random Orbital Systems

## 3M™ Abrasive Discs for Orbital Sanding

For more than 100 years, 3M Science has provided technologies designed to make your life easier and improve the world — one finish at a time. 3M offers the most advanced technologies and processes in the industry — and a wide selection of sanding discs to tackle any job.

3M™ Random Orbital Sanding Discs are designed to handle your specific sanding and finishing needs. Primary applications include stock removal, light weld blending, and paint preparation of surfaces from carbon steel to aluminum. The 3M portfolio offers the best sanding discs for metal applications to get the job done right.

**3M™ and Scotch-Brite™ Disc Selection Guide**

Performance	3M ID	Anti-Loading or Grinding Aid	Backing	Application		Material Type			Attachment System		
				Blending	Finishing	Stainless Steel	Aluminum	Carbon Steel	Stikit™/PSA	Hookit™	Clean Sanding
Premium	732U	✓	C-Paper	●		●	●	●	●	●	●
	763U		F-Paper	●				●	●	●	●
	775L	✓	Film	●	●	●	●	●	●	●	●
	777F	✓	Y-Cloth	●		●		●	●		
	900DZ		J-Cloth	●			●		●	●	●
	947A	✓	X-Cloth	●		●		●		●	
	7447 PRO		Non-Woven		●	●	●	●		●	
Advanced	236U	✓	C-Paper	●	●		●	●	●	●	●
	341D/348D		X-Cloth	●	●	●		●	●		
	375L	✓	Film	●	●		●	●	●	●	†
Good	202DZ		J-Cloth		●		●	●	●		
	426U	✓	A-Paper		●		●		●	●	●

† 375L Clean Sanding Discs available in grades 60–P400.

# 3M™ Cubitron™ II Discs

## 3M™ Cubitron™ II Stikit™ Film Discs 775L

- Cuts Faster — Increased throughput with faster sanding and more parts per disc
- Lasts Longer — Lower costs with long disc life and fewer disc changes
- Consistent Finish — Minimal rework due to consistent finish quality



UPC	Size	Grade	Discs
<b>Rolls</b>			
051125-86810-5	5" x NH	80+	100/4
051125-86811-2	5" x NH	120+	125/4
076308-64276-1	5" x NH	150+	100/4
076308-64280-8	5" x NH	180+	100/4
076308-64284-6	5" x NH	220+	100/4
076308-47091-3	5" x NH	240+	100/4
076308-47084-5	5" x NH	320+	100/4
638060-05063-7	5" x NH	400+	100/4
051125-86812-9	6" x NH	80+	100/4
051125-86813-6	6" x NH	120+	125/4
051125-87049-8	6" x NH	150+	100/4
051125-87048-1	6" x NH	180+	100/4
051125-87103-7	6" x NH	220+	100/4
076308-47092-0	6" x NH	240+	100/4
076308-47103-3	6" x NH	320+	100/4
638060-05065-1	6" x NH	400+	100/4
<b>Tab Lined Film</b>			
051125-86802-0	5" x NH	80+	50/250
051125-86803-7	5" x NH	120+	50/250
076308-64275-4	5" x NH	150+	50/250
076308-64279-2	5" x NH	180+	50/250
076308-64283-9	5" x NH	220+	50/250
076308-47087-6	5" x NH	240+	50/250
076308-47083-8	5" x NH	320+	50/250
638060-05068-2	5" x NH	400+	50/250
051125-86804-4	6" x NH	80+	50/250
051125-86805-1	6" x NH	120+	50/250
051125-87053-5	6" x NH	150+	50/250
051125-87052-8	6" x NH	180+	50/250
051125-87105-1	6" x NH	220+	50/250
076308-47088-3	6" x NH	240+	50/250
076308-47105-7	6" x NH	320+	50/250
638060-05067-5	6" x NH	400+	50/250

NH = No Hole, D/F = Dust Free

## 3M™ Cubitron™ II Hookit™ Cloth Discs 947A

- Ideal for shaping, dimensioning and detailing architectural elements
- Use for leveling and finishing, especially for "body-in-white" applications
- Produces fine finish for fast surface prep



UPC	Size	Grade	Max RPM	Min/Case
076308-45699-3	3" x NH	40+	15,000	200
076308-45700-6	3" x NH	60+	15,000	200
076308-45701-3	3" x NH	80+	15,000	200
076308-45702-0	3" x NH	120+	15,000	200
076308-45703-7	5" x NH	40+	12,000	200
076308-45704-4	5" x NH	60+	12,000	200
076308-45705-1	5" x NH	80+	12,000	200
076308-45706-8	5" x NH	120+	12,000	200
076308-45707-5	6" x NH	40+	12,000	200
076308-45708-2	6" x NH	60+	12,000	200
076308-45709-9	6" x NH	80+	12,000	200
076308-45710-5	6" x NH	120+	12,000	200
<b>Dust Free</b>				
076308-45711-2	3" x D/F	40+	15,000	200
076308-45712-9	3" x D/F	60+	15,000	200
076308-45713-6	3" x D/F	80+	15,000	200
076308-45714-3	3" x D/F	120+	15,000	200
076308-45715-0	5" x D/F	40+	12,000	200
076308-45716-7	5" x D/F	60+	12,000	200
076308-45717-4	5" x D/F	80+	12,000	200
076308-45718-1	5" x D/F	120+	12,000	200
076308-45719-8	6" x D/F	40+	12,000	200
076308-45720-4	6" x D/F	60+	12,000	200
076308-45721-1	6" x D/F	80+	12,000	200
076308-45722-8	6" x D/F	120+	12,000	200

NH = No Hole, D/F = Dust Free

### Tech tip

#### 3M™ Disc Finish and Life: comparing grade 180

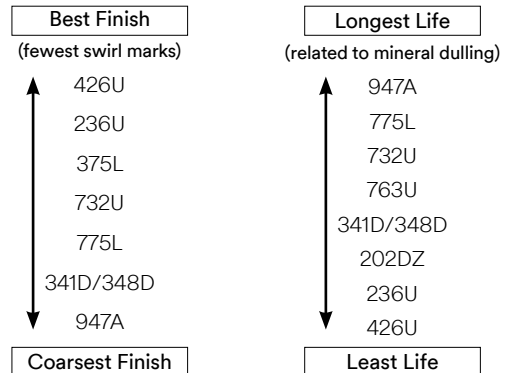

## 3M™ Cubitron™ II Discs

### 3M™ Cubitron™ II Stikit™ Paper Disc Roll 732U

- Revolutionary 3M Precision-Shaped Grain technology provides fast cut and long life
- Cuts up to 2x as fast and lasts up to 4x as long as conventional abrasives
- Ideal for a wide variety of substrates and applications focused primarily on stock removal



UPC	Diameter	Grade	Discs/Roll	Qty/Case
<b>Disc Rolls</b>				
051125-86834-1	5" x NH	80+	100	4
051125-86835-8	5" x NH	120+	100	4
076308-64278-5	5" x NH	150+	100	4
076308-64282-2	5" x NH	180+	100	4
076308-64286-0	5" x NH	220+	100	4
051125-86836-5	6" x NH	80+	100	4
051125-86837-2	6" x NH	120+	100	4
051125-87066-5	6" x NH	150+	100	4
051125-87067-2	6" x NH	180+	100	4
051125-87101-3	6" x NH	220+	100	4

<b>Paper Backing with Tabbed Liner</b>				
UPC	Diameter	Grade	Discs/Roll	Qty/Case
051125-86826-6	5" x NH	80+	50	5
051125-86827-3	5" x NH	120+	50	5
076308-64277-8	5" x NH	150+	50	5
076308-64281-5	5" x NH	180+	50	5
076308-64285-3	5" x NH	220+	50	5
051125-86828-0	6" x NH	80+	50	5
051125-86829-7	6" x NH	120+	50	5
051125-87074-0	6" x NH	150+	50	5
051125-87075-7	6" x NH	180+	50	5
051125-87102-0	6" x NH	220+	50	5

NH = No Hole

## Scotch-Brite™ Discs

### Scotch-Brite™ Discs 7447 PRO

- Fast, consistent performance
- Helps reduce surface prep time on a variety of applications
- Paint and primer preparation on airplanes, cars, trucks and other motor vehicles
- Scuff sanding of sealer coatings on cabinetry and furniture
- Refine finishes on stainless steel appliances, food processing, pharmaceutical and surgical equipment

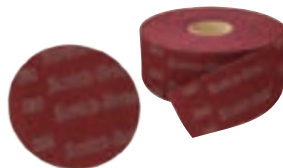

UPC	Size	Grade	Color	Min/Case
<b>Discs</b>				
048011-64959-7	5" Dia	A VFN	Maroon	100
048011-64960-3	6" Dia	A VFN	Maroon	100
<b>Sheets</b>				
048011-64958-0	3-2/3" x 9-1/4"	A VFN	Maroon	100
076308-77184-3	3" x 8"	A VFN	Maroon	40

## 3M™ Stikit™ Discs

### 3M™ Stikit™ Disc 202DZ

- Aluminum oxide on a durable J wt cloth backing
- Excellent for use on aluminum and brass
- Open coat resists loading
- Individual discs with liners



UPC	Diameter	Grade	Min/Case
<b>Paper Backing</b>			
051111-50450-5	5"	80	50/250
051111-50451-2	5"	P100	50/250
051111-50452-9	5"	P120	50/250
051111-50453-6	5"	P150	50/250
051111-50454-3	5"	P180	50/250
051111-50455-0	5"	P220	50/250
051111-50459-8	6"	80	50/250
051111-50460-4	6"	P100	50/250
051111-50461-1	6"	P120	50/250
051111-50462-8	6"	P150	50/250
051111-50463-5†	6"	P180	50/250
051111-50464-2	6"	P220	50/250

†Made-to-Order

### 3M™ Stikit™ Disc Roll 236U

- Premium aluminum oxide on a C wt paper backing
- Discs for paint, primer, wood, metal, plastic and fiberglass
- Strong paper backing provides durability and increased cut rate
- Open coat minimizes loading
- Load resistant coating



UPC	Diameter	Grade	Discs/Roll	Qty/Case
<b>Paper Backing</b>				
051141-55540-9	5"	P80	100	4
051141-55541-6	5"	P100	100	4
051141-55542-3	5"	P120	100	4
051141-55543-0	5"	P150	100	4
051141-55544-7	5"	P180	100	4
051141-55545-4	5"	P220	100	4
051141-55546-1	5"	P240	100	4
051141-55547-8	5"	P320	100	4
051141-55548-5	5"	P400	100	4
051141-55549-2	5"	P500	100	4
051141-55560-7	6"	P80	100	4
051141-55561-4	6"	P100	100	4
051141-55562-1	6"	P120	100	4
051141-55563-8	6"	P150	100	4
051141-55564-5	6"	P180	100	4
051141-55565-2	6"	P220	100	4
051141-55566-9	6"	P240	100	4
051141-55567-6	6"	P320	100	4
051141-55568-3	6"	P400	100	4
051141-55569-0	6"	P500	100	4

# 3M™ Stikit™ Discs

## 3M™ Stikit™ Disc Roll 341D

- Aluminum oxide on a durable X wt cloth backing
- Resin bonded for heat resistance



UPC	Diameter	Grade	Discs/Roll	Qty/Case
<b>Cloth Backing</b>				
051144-21752-6	5" X NH	50	100	4
051144-21751-9	5" X NH	60	100	4
051144-21750-2	5" X NH	80	100	4
051144-21749-6	5" X NH	P100	100	4
051144-21748-9	5" X NH	P120	100	4
051144-21746-5	5" X NH	P180	100	4
051144-21762-5	6" X NH	60	100	4
051144-21761-8	6" X NH	80	100	4

NH = No Hole

## 3M™ Stikit™ Film Disc Roll 375L

- Durable film construction provides tear resistant properties
- Premium abrasive and load resistant coating provide fast cut and long life
- Flexible, smooth film backing conforms to contours and rounded edges
- Produces a uniform and consistent finish because of the flatness of the film backing



UPC	Diameter	Grade	Min/Case
051115-66793-0	5" x NH	P80	100/4
051115-66794-7	5" x NH	P100	100/4
051115-66795-4	5" x NH	P120	100/4
051115-66796-1	5" x NH	P150	100/4
051115-66797-8	5" x NH	P180	100/4
051115-66798-5	5" x NH	P220	100/4
051115-66799-2	5" x NH	P240	100/4
051115-66801-2	5" x NH	P320	100/4
051115-66802-9	5" x NH	P400	100/4
051115-66803-6	6" x NH	P80	100/4
051115-66804-3	6" x NH	P100	100/4
051115-66805-0	6" x NH	P120	100/4
051115-66806-7	6" x NH	P150	100/4
051115-66807-4	6" x NH	P180	100/4
051115-66808-1	6" x NH	P220	100/4
051115-66809-8	6" x NH	P240	100/4
051115-66811-1	6" x NH	P320	100/4
051115-66812-8	6" x NH	P400	100/4

NH = No Hole

## 3M™ Stikit™ Disc Roll 426U

- Silicon carbide abrasive on a flexible A wt paper backing
- Features a load resistant coating
- Delivers good cut and excellent finish



UPC	Diameter	Grade	Discs/Roll	Qty/Case
051141-27775-2	5" x NH	80	125	10
051141-27776-9	5" x NH	100	125	10
051141-27777-6	5" x NH	120	125	10
051141-27778-3	5" x NH	150	175	6
051141-27779-0	5" x NH	180	175	6
051141-27780-6	5" x NH	220	175	6
051141-27781-3	5" x NH	240	175	6
051141-27782-0	5" x NH	280	175	6
051141-27783-7	5" x NH	320	175	6
051141-27784-4	5" x NH	400	175	6
051141-27785-1	6" x NH	80	125	10
051141-27786-8	6" x NH	100	125	10
051141-27787-5	6" x NH	120	125	10
051141-27788-2	6" x NH	150	175	6
051141-27789-9	6" x NH	180	175	6
051141-27790-5	6" x NH	220	175	6
051141-27791-2	6" x NH	240	175	6
051141-27792-9	6" x NH	320	175	6

NH = No Hole

## 3M™ Stikit™ Disc Roll 763U

- 3M ceramic aluminum oxide blend abrasive grain on a heavy F wt paper backing



UPC	Diameter	Grade	Discs/Roll	Qty/Case
<b>Paper Backing</b>				
051144-80942-4	5" x NH	60	100	4
051144-80943-1	5" x NH	80	100	4
051144-80944-8	5" x NH	P100	100	4
051144-80945-5	5" x NH	P120	100	4
051144-80946-2	6" x NH	60	100	4
051144-80947-9	6" x NH	80	100	4

NH = No Hole

## 3M™ Stikit™ Cloth Disc 900DZ

- 3M™ Ceramic Abrasive Grain on a light, J-weight cloth
- Wear-resistant backing, flexible and ideal for both flat and contour sanding



UPC	Diameter	Grade	Min/Case
051141-28099-8	5" x NH	60	50/250
051111-49639-8	5" x NH	80	50/250
051111-49640-4	5" x NH	P100	50/250
051111-49641-1	5" x NH	P120	50/250
051111-49643-5	5" x NH	P150	50/250
051111-49642-8	5" x NH	P180	50/250
051111-49644-2	5" x NH	P220	50/250

NH = No Hole

# 3M™ Stikit™ Discs

## 3M™ Stikit™ Cloth Disc 900DZ (cont)

UPC	Diameter	Grade	Min/Case
<b>Dust Free</b>			
051141-28098-1	5" x D/F	60	50/250
051141-28092-9	5" x D/F	80	50/250
051141-28093-6	5" x D/F	P100	50/250
051141-28094-3	5" x D/F	P120	50/250
051141-28096-7	5" x D/F	P150	50/250
051141-28095-0	5" x D/F	P180	50/250
051141-28097-4	5" x D/F	P220	50/250

D/F = Dust Free

# 3M™ PSA Discs

## 3M™ PSA Cloth Disc 348D

- Aluminum oxide on an X wt cloth backing
- Heavy-duty, cloth-backed discs for more aggressive applications
- Provides excellent adhesion while removing easily

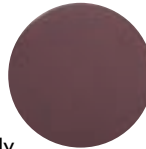

UPC	Diameter	Grade	Min/Case
<b>Cloth Backing</b>			
051144-20913-2	2"	36	50/200
051144-20911-8	2"	50	50/200
051144-20910-1	2"	60	50/200
051144-20909-5	2"	80	50/200
051144-20908-8	2"	P100	50/200
051144-20907-1	2"	P120	50/200
051144-01335-7	3"	40	50/200
051144-01334-0	3"	50	50/200
051144-01333-3	3"	60	50/200
051144-01332-6	3"	80	50/200
051144-01331-9	3"	P100	50/200
051144-01330-2	3"	P120	50/200
051144-20891-3	5"	36	50/250
051144-20890-6	5"	40	50/250
051144-20889-0	5"	50	50/250
051144-20888-3	5"	60	50/250
051144-20887-6	5"	80	50/250
051144-20886-9	5"	P100	50/250
051144-20885-2	5"	P120	50/250
051144-20884-5	5"	P150	50/250
051144-20883-8	5"	P180	50/250
051144-20881-4	5"	P240	50/250
051144-21639-0	6"	36	50/250
051144-21731-1	6"	40	50/250
051144-20879-1	6"	50	50/250
051144-20878-4	6"	60	50/250
051144-20877-7	6"	80	50/250
051144-20876-0	6"	P100	50/250
051144-21497-6	6"	P120	50/250

## 3M™ PSA Cloth Disc 348D (cont)

UPC	Diameter	Grade	Min/Case
<b>Cloth Backing</b>			
051144-20874-6	8"	36	50/250
051144-20873-9	8"	40	50/250
051144-20871-5	8"	60	50/250
051144-20870-8	8"	80	50/250
051144-20869-2	8"	P100	50/250
051144-20868-5	8"	P120	50/250
051144-88906-8	12"	36	10
051144-88905-1	12"	40	10
051144-88904-4	12"	50	10
051144-88903-7	12"	60	10
051144-88902-0	12"	80	10
051144-88901-3	12"	P100	10
051144-88890-0	16"	36	10
051144-88889-4	16"	40	10
051144-88887-0	16"	60	10
051144-88886-3	16"	80	10
051144-88882-5	18"	36	10
051144-88880-1	18"	60	10
051144-88878-8	20"	36	10
051144-88877-1	20"	40	10
051144-88876-4	20"	50	10
051144-88875-7	20"	60	10
051144-88874-0	20"	80	10
051144-20802-9	24"	36	10
051144-20801-2	24"	40	10
051144-20798-5	24"	80	10

## 3M™ PSA Disc 777F

- 3M ceramic aluminum oxide blend abrasive grain on a polyester cloth backing
- Heavy-duty YF wt backing provides great strength and flexibility
- Provides long life and fast cut on multiple surfaces
- Includes a grinding aid for cooler running



UPC	Diameter	Grade	Qty/Case
<b>Cloth Backing</b>			
051144-88869-6	12"	36	10
051144-88873-3	12"	40	10
051144-88872-6	12"	50	10
051144-88871-9	12"	60	10
051144-88870-2	12"	80	10

## 3M™ Power Tools: Random Orbital Systems

### 3M™ Random Orbital Series: Elite Series

#### Upgrades from Original Series:

Improved durability, ergonomics and noise level

- 1 Aluminum housing for added durability and reduced vibration;  
Durable composite cover helps prevent cracked housings
- 2 **Recessed Lever** eliminates pinch points
- 3 Extended cover with **3M™ Gripping Material** allows better control with reduced effort, insulates from cold and reduces vibration
- 4 **Safer Thumb Wheel** mounted speed control reduces inadvertent speed changes
- 5 Wider port for **more efficient dust capture**
- 6 **Internal Muffler** results in less breakage, SGV 6 dB quieter
- 7 **Integrated Wrist Support** for comfort and leverage
- 8 Clearance for large inlet coupler
- 9 **Center Mount Exhaust** for more finger room, better dust collection airflow



**Highlighted Text** = Proprietary 3M design feature

# 3M™ Power Tools: Random Orbital Systems

## 3M™ Elite Non-Vacuum Random Orbital Sanders

- Powerful and popular non-vacuum tools meet or exceed highest performance standards



28494  
28496



28583/28495/28497  
28708/28498



28582/28499  
28500/28501

UPC	Model	Tool Dia Inch (mm)	Orbit Dia Inch (mm)	Motor HP (W)	Max RPM	Noise Level dBA (power)	Weight Pound (kg)	Length Inch (mm)	Height Inch (mm)	Airflow Rate SCFM (LPM)	Pad Included
051141-28494-1	28494	3 (77)	3/16 (5)	0.28 (209)	12,000	73 (84)	1.52 (.692)	5.78 (147)	3.64 (92.5)	17 (481)	Hookit™ 20350
051125-87092-4	87092	3 (77)	3/32 (2.5)	0.28 (209)	12,000	73 (84)	1.31 (.596)	5.78 (147)	3.38 (86)	17 (481)	Hookit™ 20350
051141-28583-2	28583	5 (127)	3/8 (9.5)	0.28 (209)	12,000	74 (85)	1.81 (.825)	6.77 (172)	3.58 (91)	17 (481)	Stikit™ 20351
051141-28495-8	28495	5 (127)	5/16 (8)	0.28 (209)	12,000	74 (85)	1.8 (.817)	6.77 (172)	3.58 (91)	17 (481)	Stikit™ 20351
051141-28497-2	28497	5 (127)	3/16 (5)	0.28 (209)	12,000	74 (85)	1.76 (.8)	6.77 (172)	3.58 (91)	17 (481)	Stikit™ 20351
051141-28708-9	28708	5 (127)	3/16 (5)	0.28 (209)	12,000	74 (85)	1.76 (.8)	6.77 (172)	3.58 (91)	17 (481)	Hookit™ 20352
051141-28498-9	28498	5 (127)	3/32 (2.5)	0.28 (209)	12,000	74 (85)	1.72 (.781)	6.77 (172)	3.58 (91)	17 (481)	Stikit™ 20351
051141-28582-5	28582	6 (152)	3/8 (9.5)	0.28 (209)	12,000	75 (86)	1.94 (.881)	7.36 (187)	3.58 (91)	17 (481)	Stikit™ 20354
051141-28499-6	28499	6 (152)	5/16 (8)	0.28 (209)	12,000	75 (86)	1.86 (.844)	7.36 (187)	3.58 (91)	17 (481)	Stikit™ 20354
051141-28500-9	28500	6 (152)	3/16 (5)	0.28 (209)	12,000	75 (86)	1.91 (.869)	7.36 (187)	3.58 (91)	17 (481)	Stikit™ 20354
051141-28501-6	28501	6 (152)	3/32 (2.5)	0.28 (209)	12,000	75 (86)	2.1 (.957)	7.36 (187)	3.58 (91)	17 (481)	Stikit™ 20354

## 3M™ Elite Self-Generating Vacuum Random Orbital Sanders\*

- Easily attaches to your existing central vacuum system for efficient dust-evacuation



28511  
28513

28563/28512  
28514/28515

28562/28510  
28516/28517

UPC	Model	Tool Dia Inch (mm)	Orbit Dia Inch (mm)	Motor HP (W)	Max RPM	Noise Level dBA (power)	Weight Pound (kg)	Length Inch (mm)	Height Inch (mm)	Airflow Rate SCFM (LPM)	Pad Included
051141-28511-5	28511	3 (77)	3/16 (5)	0.28 (209)	12,000	85 (96)	1.65 (.752)	8.22 (209)	3.64 (92.5)	17 (481)	Hookit™ 20350
051141-28513-9	28513	3 (77)	3/32 (2.5)	0.28 (209)	12,000	85 (96)	1.43 (.651)	8.14 (207)	3.44 (87.5)	17 (481)	Hookit™ 20350
051141-28563-4	28563	5 (127)	3/8 (9.5)	0.28 (209)	12,000	84 (95)	1.93 (.874)	9.21 (234)	3.64 (92.6)	17 (481)	Hookit™ 20353
051141-28512-2	28512	5 (127)	5/16 (8)	0.28 (209)	12,000	86 (97)	1.9 (.866)	9.21 (234)	3.64 (92.6)	17 (481)	Hookit™ 20353
051141-28514-6	28514	5 (127)	3/16 (5)	0.28 (209)	12,000	86 (97)	1.87 (.85)	9.21 (234)	3.64 (92.6)	17 (481)	Hookit™ 20353
051141-28515-3	28515	5 (127)	3/32 (2.5)	0.28 (209)	12,000	86 (97)	1.83 (.833)	9.21 (234)	3.64 (92.6)	17 (481)	Hookit™ 20353
051141-28562-7	28562	6 (152)	3/8 (9.5)	0.28 (209)	12,000	87 (94)	2.06 (.939)	9.64 (245)	3.64 (92.6)	17 (481)	Hookit™ 20356
051141-28510-8	28510	6 (152)	5/16 (8)	0.28 (209)	12,000	88 (99)	2.04 (.927)	9.64 (245)	3.64 (92.6)	17 (481)	Hookit™ 20356
051141-28516-0	28516	6 (152)	3/16 (5)	0.28 (209)	12,000	89 (100)	1.99 (.904)	9.64 (245)	3.64 (92.6)	17 (481)	Hookit™ 20356
051141-28517-7	28517	6 (152)	3/32 (2.5)	0.28 (209)	12,000	88 (99)	1.92 (.874)	9.64 (245)	3.64 (92.6)	17 (481)	Hookit™ 20356

\*One (1) each of the following included: 3M™ Clean Sanding Filter Bag, Filter Bag Adapter, Hose Seal

# 3M™ Power Tools: Random Orbital Systems



## 3M™ Elite Central-Vacuum-Ready Random Orbital Sanders

- Easily attaches to your existing central vacuum system for efficient dust-evacuation

UPC	Model	Tool Dia Inch (mm)	Orbit Dia Inch (mm)	Motor HP (W)	Max RPM	Noise Level dBA (power)	Weight Pound (kg)	Length Inch (mm)	Height Inch (mm)	Airflow Rate SCFM (LPM)	Pad Included
051141-28503-0	28503	3 (77)	3/16 (5)	0.28 (209)	12,000	72 (83)	1.63 (.742)	7.99 (203)	3.64 (92.5)	17 (481)	Hookit™ 20350
051141-28505-4	28505	3 (77)	3/32 (2.5)	0.28 (209)	12,000	72 (83)	1.41 (.644)	7.91 (201)	3.44 (87.5)	17 (481)	Hookit™ 20350
051141-28561-0	28561	5 (127)	3/8 (9.5)	0.28 (209)	12,000	73 (84)	1.91 (.868)	8.93 (227)	3.64 (92.6)	17 (481)	Hookit™ 20353
051141-28504-7	28504	5 (127)	5/16 (8)	0.28 (209)	12,000	73 (84)	1.89 (.86)	8.93 (227)	3.64 (92.6)	17 (481)	Hookit™ 20353
051141-28506-1	28506	5 (127)	3/16 (5)	0.28 (209)	12,000	73 (84)	1.86 (.844)	8.93 (227)	3.64 (92.6)	17 (481)	Hookit™ 20353
051141-28507-8	28507	5 (127)	3/32 (2.5)	0.28 (209)	12,000	73 (84)	1.82 (.826)	8.93 (227)	3.64 (92.6)	17 (481)	Hookit™ 20353
051141-28560-3	28560	6 (150)	3/8 (9.5)	0.28 (209)	12,000	76 (87)	2.04 (.930)	9.37 (238)	3.64 (92.6)	17 (481)	Hookit™ 20356
051141-28502-3	28502	6 (150)	5/16 (8)	0.28 (209)	12,000	76 (87)	2.02 (.918)	9.37 (238)	3.64 (92.6)	17 (481)	Hookit™ 20356
051141-28508-5	28508	6 (150)	3/16 (5)	0.28 (209)	12,000	76 (87)	1.97 (.896)	9.37 (238)	3.64 (92.6)	17 (481)	Hookit™ 20356
051141-28509-2	28509	6 (150)	3/32 (2.5)	0.28 (209)	12,000	76 (87)	1.91 (.869)	9.37 (238)	3.64 (92.6)	17 (481)	Hookit™ 20356

## 3M™ Elite Series Mini Orbital Sander

- Longer life vanes and improved skirt attachment system for greater durability
- Exclusive 3M™ Gripping Material cover for operator comfort
- Aluminum body for lighter weight and improved balance
- 3M™ Roloc™ Attachment System for sanding pad and integral tool hanger for increased usability



UPC	Model	PSI	Tool Dia Inch (mm)	Orbit Dia Inch (mm)	Motor HP (W)	Max RPM	Noise Level dBA (power)	Weight Pound (kg)	Length Inch (mm)	Height Inch (mm)	Airflow Rate SCFM (LPM)	Thread Size
051141-28737-9	28737	90	1-1/4 × 3/16	1/8 (3)	0.48 (358)	8,000	76 (87)	0.6 (0.3)	8 (193)	4 (104)	23 (651)	5/16-24 EXT

## 3M™ Mini-Random Orbital Sander

- Ergonomically designed for operator comfort and control
- Low profile design reduces chance of tipping and undercutting
- Direct mount 3M™ Roloc™ Sanding Pad allows close proximity to the work surface
- 3M™ Roloc™ O2345 w/Stikit™ Face pad included



UPC	Model	PSI	Tool Dia Inch (mm)	Orbit Dia Inch (mm)	Motor HP (W)	Max RPM	Noise Level dBA (power)	Weight Pound (kg)	Length Inch (mm)	Height Inch (mm)	Airflow Rate SCFM (LPM)
051141-20244-0	20244	90	1-1/4 × 3/16	3/16 (5)	0.24 (179)	8,000	73 (80)	1.0 (0.5)	5 (120)	3 (85)	15 (425)

## 3M™ Random Orbital Sander, 2-Hand

28337/28335



UPC	Model	Vacuum	Orbit Dia Inch (mm)	Motor HP (W)	Max RPM	Noise Level dBA (power)	Weight Pound (kg)	Length Inch (mm)	Height Inch (mm)	Airflow Rate SCFM (LPM)	Pad Included
051141-28337-1	28337	Central/Non-Vac	6 (150)	0.45 (336)	12,000	81 (89)	2.90 (1.32)	12.93 (328.3)	4.43 (112.6)	21 (594)	Hookit™ 20356*
051141-28335-7	28335	Self-Gen Vac	6 (150)	0.45 (336)	20,000	91 (94)	2.90 (1.32)	12.93 (328.3)	4.43 (112.6)	21 (594)	Hookit™ 20356*

\*For 5" sanding using the 2-Hand Sander, use the 5" 3M™ Hookit™ D/F Disc Pad 28411

# 3M™ Power Tools: Random Orbital Systems



## 3M™ Non-Vacuum Random Orbital Sanders

- Powerful and popular non-vacuum tools meet or exceed highest performance standards

UPC	Model	Tool Dia Inch (mm)	Orbit Dia Inch (mm)	Motor HP (W)	Max RPM	Noise Level dBA (power)	Weight Pound (kg)	Length Inch (mm)	Height Inch (mm)	Airflow Rate SCFM (LPM)	Pad Included
051141-20317-1	20317	5 (127)	3/16 (5)	0.28 (209)	12,000	80 (88)	1.65 (.75)	6.12 (155.4)	3.33 (84.5)	17 (481)	Hookit™ 20351
051141-20324-9	20324	6 (150)	5/16 (8)	0.28 (209)	12,000	75 (85)	1.78 (.81)	6.47 (164.4)	3.33 (84.5)	17 (481)	Hookit™ 20354
051141-20325-6	20325	6 (150)	3/16 (5)	0.28 (209)	12,000	79 (83)	1.74 (.79)	6.47 (164.4)	3.33 (84.5)	17 (481)	Hookit™ 20354







## 3M™ Self-Generated Vacuum Random Orbital Sanders\*

- Take dust-management to the next level with powerful self-generated vacuum tools
- Featuring 3M patented Clean Sanding system with improved filter bag

UPC	Model	Tool Dia Inch (mm)	Orbit Dia Inch (mm)	Motor HP (W)	Max RPM	Noise Level dBA (power)	Weight Pound (kg)	Length Inch (mm)	Height Inch (mm)	Airflow Rate SCFM (LPM)	Pad Included
051141-20319-5	20319	5 (127)	3/16 (5)	0.28 (209)	12,000	85 (93)	1.83 (.83)	6.12 (155.4)	3.33 (84.5)	17 (481)	Hookit™ 20353
051141-20208-2	20208	6 (150)	5/16 (8)	0.28 (209)	12,000	82 (92)	1.96 (.89)	6.47 (164.4)	3.33 (84.5)	17 (481)	Hookit™ 20353
051141-20327-0	20327	6 (150)	3/16 (5)	0.28 (209)	12,000	83 (92)	1.96 (.89)	6.47 (164.4)	3.33 (84.5)	17 (481)	Hookit™ 20353

\*One (1) each of the following included: 3M™ Clean Sanding Filter Bag, Filter Bag Adapter, Hose Seal

# Accessories: Random Orbital Systems

Product	UPC	For Use With	Size/Description	Max RPM	Max OPM	Qty/Case
<b>3M™ Hook-and-Loop Disc Pad Holder 905</b> 	048011-09448-9	Scotch-Brite™ Surface Conditioning Discs	5" x 5/16-24 EXT	10,000	N/A	1
<b>3M™ Hookit™ Disc Pad</b> 	051141-28709-6	3M™ Hookit™ Discs and Scotch-Brite™ Coating Removal Discs	6" x 3/4" x 5/16-24 EXT	12,000	12,000	10
<b>3M™ Hookit™ Low Profile Disc Pad</b> 	051141-20352-2	3M™ Hookit™ Discs and Scotch-Brite™ RO Discs	5" x 3/8" x 5/16-24 EXT; Low Profile	12,000	12,000	10
	051141-20355-3	3M™ Hookit™ Discs and Scotch-Brite™ RO Discs	6" x 3/8" x 5/16-24 EXT; Low Profile	12,000	12,000	10
	051141-28852-9	Scotch-Brite™ 7447 PRO Discs	5" x 3/8" x 5/16-24	12,000	12,000	10
<b>3M™ Stikit™ Disc Pads</b> 	051131-05545-2	3M™ Stikit™ Discs	5" x 11/16" 5/16-24 EXT; Low Profile Finishing	12,000	12,000	10
	051131-05546-9	3M™ Stikit™ Discs	6" x 11/16" 5/16-24 EXT; Low Profile Finishing	10,000	12,000	10
	051144-05575-3	3M™ Stikit™ Discs	5" x 3/4" x 5/16-24	10,000	12,000	10
	051141-28772-0	3M™ Stikit™ Discs	6" x 3/4" x 5/16-24	10,000	12,000	10
	051141-20351-5	3M™ Stikit™ Discs	5" x 3/8" x 5/16-24 EXT; Red Foam; Low Profile	12,000	12,000	10
	051141-20354-6	3M™ Stikit™ Discs	6" x 3/8" x 5/16-24 EXT; Red Foam; Low Profile	12,000	12,000	10
	051144-81821-1	3M™ Stikit™ Discs	5" x 3/4" 5/16-24 EXT	10,000	12,000	10

# Abrasive Belt Systems

## 3M™ Belts

3M is the one-stop shop for all your coated abrasive metalworking belt needs! We offer a product tailored to nearly every application and performance level. To select the best product for your application, check out our easy-to-use Belt Selection Guide. Each tier of product offers best-in-class performance at various price points. Once you have selected the product, use the Availability Guide to select your grade. The following section includes our most popular belt items, but remember, other custom sizes are available.

### How to Use the Coated Abrasive Belt Selection Guide

1. Find the machine type that you will run this belt on.
2. Move down to the metal type that is being worked on.
3. Select the product from the list of Recommended — Alternative — Finishing/Polishing belts.\*
4. Check the Availability Guide for the grade.
5. Find the product on the following pages for available sizes.
6. If your size is not listed, contact your 3M distributor or 3M representative for ordering instructions.

### 3M™ Coated Abrasive Belt Selection Guide

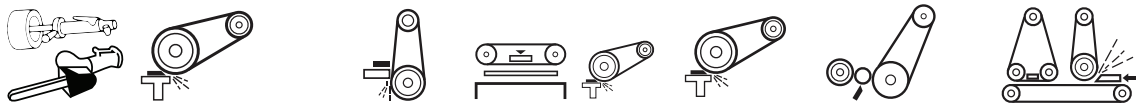

Recommended Starting Point	Portable File Belt	Coarse Grade High Pressure Grinding	Backstand/Off Hand Low-Med Pressure	Stroke Sander	Bench Top Belt Sander	Slack of Belt Sander	Centerless and Roll Grinding		Flat and Wide Belt Finishing	
							Dry	Wet	Dry	Wet
<b>Carbon Steel and Cast Iron</b>										
<b>Recommended</b>	784F	984F	784F	384F	784F	947A	784F	984F	784F	784F
<b>Alternative</b>	947A	994F	984F	784F	947A	723D	384F	784F	577F	577F
<b>Finishing/Polishing</b>	384F	—	947A	947A	384F	784F	347FC	363FC	384F	384F
	—	—	—	—	—	—	399F	399F	399F	399F
<b>Stainless Steel and Cobalt Chrome</b>										
<b>Recommended</b>	784F	984F	784F	784F	784F	947A	784F	984F	784F	784F
<b>Alternative</b>	947A	997F	984F	947A	947A	784F	384F	784F	577F	577F
<b>Finishing/Polishing</b>	384F	—	947A	384F	384F	—	347FC	363FC	461F	461F
	—	—	—	—	—	—	399F	399F	399F	399F
<b>Aluminum and Soft Substrates</b>										
<b>Recommended</b>	981F	984F	981F	981F	981F	947A	784F	784F	384F	384F
<b>Alternative</b>	784F	784F	784F	784F	784F	784F	384F	384F	361F	361F
<b>Finishing/Polishing</b>	384F	—	384F	384F	384F	384F	237AA	253FA	461F	461F
<b>Titanium</b>										
<b>Recommended</b>	967F	967F	967F	—	967F	947A	N/A	966F	N/A	966F
<b>Alternative</b>	784F	984F	784F	—	784F	784F	N/A	784F	N/A	461F
<b>Finishing/Polishing</b>	947A	—	461F	—	947A	—	N/A	—	N/A	—
	—	—	—	—	—	—	N/A	463FC	N/A	463FC

\*Recommended is the potential best starting point based on the application. Alternative is another option based either on a different flexibility and durability need, or a possible lower initial belt cost. Value shown in belt process can be viewed as an increase in throughput, lower overall belt cost, and faster sanding or grinding time.



## The Science of 3M Precision-Shaped Grain

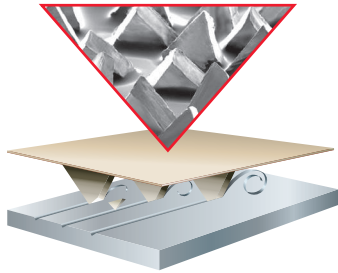

3M precision-shaped grain uses 3M microreplication technology to form sharp peaks that easily “slice” through metal — cutting cooler, faster and lasting longer than conventional abrasive grain. That means more consistent performance with fewer disc changes — so you can get more work done over the life of your disc.

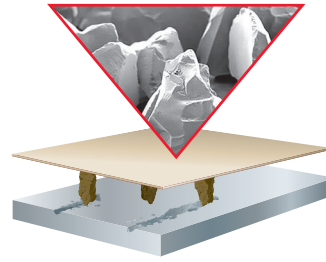

Conventional ceramic abrasive grain tends to “plow” through the metal, causing heat to build up in the workpiece and the abrasive — resulting in a slower cut and shorter disc life.

## 3M™ Cubitron™ II Cloth Belts

### 984F

- Made with revolutionary 3M precision-shaped abrasive grain technology
- YF wt backing
- Average up to 30% faster cutting on hard-to-grind metals than the next-best competitive belt
- Lasts up to 4 times as long as conventional ceramic aluminum oxide belts
- Cuts cooler — diverts heat from the work piece and belt to the swarf
- Helps eliminate burnishing and heat stress
- Reduces changeouts and downtime in robotic and pressure assisted applications



UPC	W x L	Grade	Qty/Case
051141-55032-9	1/4" x 24"	60+	200
051141-27511-6	1/2" x 18"	36+	200
051141-55041-1	1/2" x 18"	60+	200
051141-55048-0	1/2" x 18"	80+	200
051141-27512-3	1/2" x 24"	36+	200
051141-55031-2	1/2" x 24"	60+	200
051141-55054-1	1/2" x 24"	80+	200
051141-55064-0	3/4" x 18"	36+	200
051141-55030-5	3/4" x 18"	60+	200
051141-55047-3	3/4" x 18"	80+	200
051141-55065-7	3/4" x 20-1/2"	36+	200
051141-55055-8	3/4" x 20-1/2"	80+	200
051141-55046-6	1" x 11"	60+	500
051141-55050-3	1" x 11"	80+	500
051141-55060-2†	1" x 42"	80+	200
051141-27514-7	1" x 132"	36+	100
051141-55039-8	1" x 132"	60+	200
051141-55052-7	1" x 132"	80+	200

†Made-to-Order

### 984F (cont)

UPC	W x L	Grade	Qty/Case
051141-55066-4†	1-1/2" x 132"	36+	50
051141-55068-8	2" x 60"	36+	50
051141-55036-7†	2" x 60"	60+	50
051141-27516-1	2" x 72"	36+	50
051141-55034-3	2" x 72"	60+	50
051141-55057-2	2" x 72"	80+	50
051141-55067-1	2" x 118"	36+	50
051141-27460-7	2" x 132"	36+	50
051141-55044-2	2" x 132"	60+	50
051141-55056-5	2" x 132"	80+	50
051141-55069-5	2-1/2" x 60"	36+	50
051141-27853-7†	2-1/2" x 60"	60+	50
051141-55058-9†	2-1/2" x 60"	80+	50
051141-27461-4	3" x 132"	36+	25
051141-55043-5	3" x 132"	60+	25
051141-55051-0	3" x 132"	80+	25
051141-55042-8	3-1/2" x 15-1/2"	60+	50
051141-55049-7	3-1/2" x 15-1/2"	80+	50
051141-27462-1	4" x 132"	36+	25
051141-55070-1	5" x 132"	36+	25
051141-55071-8	6" x 48"	36+	20
051141-55037-4	6" x 48"	60+	20
051141-55059-6†	6" x 48"	80+	20
051141-55035-0	6" x 60"	60+	20
051141-27515-4	6" x 132"	36+	10
051141-55072-5	8" x 107"	36+	10
051141-27513-0	8" x 132"	36+	10
051141-55063-3†	37" x 60"	80+	2
051141-55062-6†	37" x 75"	80+	2

†Made-to-Order

## 3M™ Cubitron™ II Cloth Belts

### 947A

- Made with revolutionary 3M precision-shaped abrasive grain technology
- Flexible X wt poly-cotton backing
- Optimized for low-medium pressure applications on stainless, mild steel and aluminum



UPC	W x L	Grade	Qty/Case
051125-94700-8	1/4" x 24"	60+	200
051125-94701-5	1/4" x 24"	80+	200
051125-94702-2	1/4" x 24"	120+	200
051125-86773-3	1/2" x 18"	40+	200
051125-94703-9	1/2" x 18"	60+	200
051125-94704-6	1/2" x 18"	80+	200
051125-94705-3	1/2" x 18"	120+	200
051125-86774-0	1/2" x 24"	40+	200
051125-94706-0	1/2" x 24"	60+	200
051125-94707-7	1/2" x 24"	80+	200
051125-94708-4	1/2" x 24"	120+	200
051119-16613-2	3/4" x 18"	40+	200
051125-94709-1	3/4" x 18"	60+	200
051125-94710-7	3/4" x 18"	80+	200
051125-94711-4	3/4" x 18"	120+	200
051125-86776-4	3/4" x 20-1/2"	40+	200
051125-94712-1	3/4" x 20-1/2"	60+	200
051125-94713-8	3/4" x 20-1/2"	80+	200
051125-94714-5	3/4" x 20-1/2"	120+	200
051125-94715-2	1" x 11"	80+	200
051125-94716-9	1" x 11"	120+	50
051125-94717-6	1" x 30"	80+	200
051125-94718-3	1" x 30"	120+	200
051125-94719-0	1" x 42"	80+	200
051125-94720-6	1" x 42"	120+	200
051125-94721-3	2" x 60"	60+	50
051125-94722-0	2" x 60"	80+	50
051125-94723-7	2" x 60"	120+	50
051125-94724-4	2" x 72"	60+	50
051125-94725-1	2" x 72"	80+	50
051125-94726-8	2" x 72"	120+	50
051119-30509-8	2" x 132"	40+	50
051125-94727-5	2" x 132"	60+	50
051125-94728-2	2" x 132"	80+	50
051125-94729-9	2" x 132"	120+	50
051119-22669-0	3" x 132"	40+	25
051125-94730-5	3" x 132"	60+	25
051125-94731-2	3" x 132"	80+	25
051125-94732-9	3" x 132"	120+	25
051119-30304-9	3-1/2" x 15-1/2"	40+	50
051125-94733-6	3-1/2" x 15-1/2"	60+	50
051125-94734-3	3-1/2" x 15-1/2"	80+	50
051125-94735-0	3-1/2" x 15-1/2"	120+	10
051125-94736-7	6" x 48"	60+	20
051125-94737-4	6" x 48"	80+	20
051125-94738-1	6" x 48"	120+	20

### 994F

- Made with revolutionary 3M precision-shaped abrasive grain technology
- Tough, durable ZF wt cloth backing
- Optimal for high pressure carbon steel and aluminum applications



UPC	W x L	Grade	Qty/Case
051141-28203-9	Belt sizes made to order; specify UPC, grade and belt size (W" x L")	36+	Determined by belt size

### 997F

- Made with revolutionary 3M precision-shaped abrasive grain technology
- Tough, durable ZF wt cloth backing
- Superb in high pressure stainless, cobalt chrome and nickel alloy applications



UPC	W x L	Grade	Qty/Case
076308-66767-2	Belt sizes made to order; specify UPC, grade and belt size (W" x L")	36+	Determined by belt size

### 981F

- Designed specifically for grinding on soft metal substrates like aluminum, brass and bronze
- 3M Precision-Shaped Grain cuts exceptionally fast for grinding and finishing on soft metals
- Strong mineral adhesion for reduced shelling when grinding on the edge of the belt



UPC	W x L	Grade	Qty/Case
638060-05476-5	1/2" x 18"	36+	200
638060-05477-2	1/2" x 18"	40+	200
638060-05478-9	1/2" x 18"	60+	200
638060-05479-6	1/2" x 24"	36+	200
638060-05480-2	1/2" x 24"	40+	200
638060-05481-9	1/2" x 24"	60+	200
638060-05482-6	3/4" x 18"	36+	200
638060-05483-3	3/4" x 18"	40+	200
638060-05488-8	2" x 48"	36+	50
638060-05489-5	2" x 48"	40+	50
638060-05490-1	2" x 48"	60+	50
638060-05494-9	2" x 72"	36+	50
638060-05495-6	2" x 72"	40+	50
638060-05496-3	2" x 72"	60+	50
638060-05500-7	2" x 132"	36+	50
638060-05501-4	2" x 132"	40+	50
638060-05502-1	2" x 132"	60+	50
638060-05503-8	3" x 132"	36+	25
638060-05504-5	3" x 132"	40+	25
638060-05505-2	3" x 132"	60+	25

# 3M™ Cubitron™ II Cloth Belts

## 399F

- Little or no break-in period
- Extended belt life
- Fewer rejects, less rework — higher productivity
- Up to 2 times life against competitive engineered abrasives
- Water resistant polyester backing
- Grades 180 to 600



UPC	Size	Grade	Qty/Case
076308-68265-1*	Custom sizes	P180	Determined by belt size
076308-68267-5*		P240	
076308-68269-9*		P320	
076308-68271-2*		P400	
076308-68273-6*		P600	

\*3M ID — Custom size made to order

## 723D

- Strong value without sacrificing performance
- Very flexible and conformable J wt backing
- Available in grades 100+ to 220+



UPC	Size	Grade	Qty/Case
076308-45551-4†	1" x 42"	220+	200
076308-45550-7†	2" x 72"	120+	50
076308-45548-4†	2" x 132"	120+	50
076308-45549-1†		150+	
076308-45545-3†	3" x 132"	120+	25
076308-45546-0†		150+	
076308-45547-7†		220+	
076308-68418-1†	N/A	100+	Determined by belt size
076308-68233-0†		120+	
076308-68204-0†		150+	
076308-68206-4†		180+	
076308-68208-8†		220+	

Available in grades 100+ to 220+  
†Made-to-Order

## 966F

- Constructed of durable waterproof polyester cloth backing
- Designed for heavy wet grinding of titanium, plate and slab, and other heat sensitive alloys
- Available in grades 20+ to 80+



UPC	Size	Grade	Qty/Case
076308-67152-5	Custom sizes	20+	Determined by belt size
076308-68216-3		24+	
076308-68218-7		36+	
638060-21944-7		40+	
076308-68220-0		50+	
076308-68222-4		60+	
076308-68224-8		80+	

\*3M ID — Custom size made to order

## 784F

- Excellent in medium/high pressure applications on a variety of different metals
- Strong value for medium pressure grinding and dimensioning
- Polyester waterproof backing
- Available in grades 36+ to 180+



UPC	Size	Grade	Qty/Case
051125-87317-8	1/2" x 18"	36+	200
076308-45559-0		60+	
076308-45563-7		80+	
076308-45567-5		120+	
076308-47068-5	3/4" x 18"	36+	200
076308-45555-2		60+	
076308-45562-0		80+	
076308-45572-9		120+	
076308-45556-9	1/2" x 24"	60+	200
076308-45565-1		80+	
076308-45568-2		120+	
076308-45570-5	2" x 48"	60+	50
076308-45571-2		80+	
076308-45558-3	6" x 48"	60+	20
076308-45566-8		80+	
076308-45557-6	2" x 72"	60+	50
076308-45569-9		120+	
076308-45554-5	1" x 132"	50+	100
076308-45552-1	2" x 132"	36+	50
076308-45561-3		60+	
076308-45553-8	3" x 132"	36+	25
076308-45560-6		60+	
076308-45564-4		80+	
076308-68190-6	Custom sizes	36+	Determined by belt size
076308-68191-3		50+	
076308-68192-0		60+	
076308-68193-7		80+	
076308-68194-4		120+	
076308-68195-1		150+	
076308-68196-8		180+	

Available in grades 36+ to 180+

## 967F

- Go-to product for titanium and high nickel alloys
- Grinding aid enables rough grinding on heat-sensitive alloys
- Heavy duty YF wt cloth backing stands up to high pressure applications
- Available in grades 24+ to 80+



UPC	Size	Grade	Qty/Case
076308-68238-5	Custom sizes	24+	Determined by belt size
076308-68240-8		36+	
076308-68242-2		50+	
076308-68244-6		60+	
076308-68307-8		80+	

Available in grades 24+ to 80+  
\*3M ID — Custom size made to order

# 3M™ Trizact™ Cloth Belts

The unique microreplicated construction used in 3M™ Trizact™ Abrasives can deliver consistent, predictable finishes, higher, more even rates of cut, cooler grinding and finishing temperatures, and reduced processing steps. 3M invented microreplication technology, which is the science of creating small, precisely shaped three-dimensional structures and then reproducing them on a variety of surfaces.

## 3M™ Trizact™ Belt Grading System

The unique construction of Trizact™ abrasives requires a different grading system. Grade is defined by the average particle size in microns and begins with an “A”.

3M™ Trizact™ Abrasive Grading	
Trizact Abrasive Grade	FEPA (P-Grade)
A5	P3000
A6	P2000
A10	P1500
A16	—
A20	P1200
A30	—
A35	P600
A45	P400
	P320
A60	—
A65	—
	P240
A80	—
A90	P220
A100	—
A110	P180
A130	P150
A160	P120

## The Difference is in the Construction

Trizact abrasives allow you to say “goodbye” to erratic, inconsistent finishes generated by conventional coated abrasives. Here’s why:

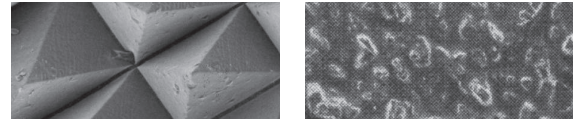

Three-dimensional structures uniformly distributed over the entire surface of 3M™ Trizact™ Abrasives (left) ensure consistent performance and eliminate belt-to-belt variation. Conventional abrasives (right), which feature randomly arranged minerals, wear and finish unevenly.



Conventional abrasives start out sharp, but they dull quickly.



3M™ Trizact™ Abrasives have three-dimensional structures containing multiple layers of abrasive mineral. As these pyramid-like structures wear, fresh, sharp mineral is exposed.

## 3M™ Trizact™ Belt Availability Guide

3M ID	Mineral	Backing	Description	Use Dry/Wet	A Grade															
					300	160	110	100	90	80	65	60	45	35	30	20	16	10	6	5
217EA*	Aluminum Oxide	Flex J wt	Low Pressure	Dry				●	●	●		●	●	●	●	●	●			
237AA*		Semi Flex X wt	Low-Med Pressure	Dry		●		●	●	●		●	●	●	●	●	●	●		
253FA		Stiff X wt	Low-Med Pressure	Wet				●	●	●		●	●	●	●	●	●	●		
305EA		Flex J wt	Fine Finishing	Dry															●	●
307EA*		Flex J wt	Low-Med Pressure	Dry				●	●	●		●	●	●	●	●	●	●		
327DC		Semi Flex X wt	Low Pressure	Dry	●	●		●			●	●	●	●						
337DC		Semi Flex X wt	Med Pressure	Dry	●	●		●			●	●	●	●						
347FC		Semi Flex X wt	High Pressure	Wet/Dry	●	●		●			●	●	●	●						
363FC		Stiff YF wt	Med-High Pressure	Wet	●	●		●			●	●	●	●						
407EA		Silicon Carbide	Flex J wt	Low-Med Pressure	Dry			●		●		●				●				
463FC	Stiff YF wt		Med-High Pressure	Wet								●			●		●	●		
953FA	Ceramic	Stiff YF wt	Med-High Pressure	Wet	●	●		●	●	●		●	●			●	●	●		

\*Go-to product

# 3M™ Trizact™ Cloth Belts

## 217EA

- Ideal for aluminum, copper, brass and zinc alloys to final finishing
- Good for low pressure applications
- Flexible belt for intermediate finish and dimensioning



UPC	W x L	Grade	Qty/Case
051125-23664-5†	4" x 84"	A45	50
051125-15686-8†	4" x 106"	A45	50
051125-20639-6	4" x 118"	A6	50
051125-14350-9	4" x 118"	A16	50
051111-66834-4	4" x 118"	A30	50
051125-13733-1†	4" x 118"	A45	50
051111-66830-6†	4" x 132"	A6	50
051111-69360-5†	4" x 132"	A16	50
051111-66835-1†	4" x 132"	A30	50
051111-66841-2†	4" x 132"	A45	50
051111-69669-9†	4" x 132"	A65	50
051125-12699-1†	4" x 168"	A30	50
051125-12479-9†	4" x 168"	A80	50

†Made-to-Order

## 237AA

- Semi-flexible abrasive
- Aluminum oxide mineral
- Great choice for stainless steel finishes



UPC	W x L	Grade	Qty/Case
051119-82624-1†	1" x 11"	A6	500
051125-32361-1†	1" x 11"	A16	500
051115-27208-0†	1" x 11"	A45	500
051111-66892-4†	1" x 11"	A65	500
051111-69366-7†	1" x 11"	A100	500
051125-22681-3†	1" x 12"	A100	200
051111-69377-3†	1" x 30"	A30	200
051125-15699-8†	1" x 42"	A16	200
051125-08603-5†	1" x 42"	A100	200
051111-69676-7†	1" x 42"	A160	200
051119-10286-4†	1" x 60"	A45	200
051115-27051-2†	1" x 60"	A65	200
051119-10263-5†	1" x 64"	A6	200
051111-66945-7†	1" x 130"	A100	50
051115-27804-4†	2" x 34"	A100	50
051111-69673-6†	2" x 48"	A16	50
051115-27731-3†	2" x 48"	A30	50
051119-09379-7†	2" x 48"	A45	50
051125-20671-6†	2" x 48"	A80	50
051111-69043-7†	2" x 48"	A100	50
051119-84184-8†	2" x 48"	A160	50

†Made-to-Order

## 237AA (cont)

UPC	W x L	Grade	Qty/Case
051119-59769-1†	2" x 60"	A80	50
051125-54544-0†	2" x 60"	A100	50
051115-27487-9†	2" x 72"	A16	50
051115-27653-8†	2" x 72"	A30	50
051115-27787-0†	2" x 72"	A65	50
051115-27904-1†	2" x 72"	A80	50
051111-69671-2†	2" x 72"	A100	50
051115-27849-5†	2" x 72"	A160	50
051125-22263-1†	2" x 118"	A30	50
051111-66856-6†	2" x 132"	A6	50
051111-69370-4†	2" x 132"	A16	50
051115-27658-3†	2" x 132"	A30	50
051111-69028-4	2" x 132"	A45	50
051111-69044-4	2" x 132"	A100	50
051125-20169-8†	2" x 148"	A100	50
051111-69294-3†	3" x 24"	A6	50
051111-69290-5†	3" x 24"	A16	50
051111-69291-2†	3" x 24"	A30	50
051125-14935-8†	3" x 24"	A80	50
051119-83067-5†	3" x 60"	A16	50
051111-69045-1†	3" x 60"	A100	50
051111-69295-0†	3" x 72"	A160	50
051111-69021-5†	3" x 90"	A30	50
051125-19954-4†	3" x 132"	A6	50
051111-51199-2	3" x 132"	A16	50
051111-51207-4	3" x 132"	A30	50
051111-51209-8	3" x 132"	A45	50
051111-69037-6†	3" x 132"	A65	50
051111-69051-2†	3" x 132"	A160	50
051111-66864-1†	3" x 148"	A16	50
051111-69292-9†	3" x 148"	A30	50
051111-69293-6†	3" x 148"	A45	50
051115-27145-8†	4" x 36"	A65	50
051111-66949-5†	4" x 36"	A100	50
051119-68279-3†	4" x 48"	A100	50
051115-27749-8†	4" x 90"	A6	50
051111-69016-1†	4" x 90"	A16	50
051111-51204-3	4" x 90"	A30	50
051111-69030-7†	4" x 90"	A45	50
051119-73517-8†	4" x 90"	A65	50
051115-27592-0†	4" x 90"	A80	50
051111-69672-9†	4" x 90"	A100	50
051115-27153-3†	4" x 106"	A30	50
051115-26818-2†	4" x 106"	A100	50
051111-66867-2†	4" x 118"	A16	50
051111-66878-8†	4" x 118"	A30	50
051111-66888-7†	4" x 118"	A45	50
051125-17651-4†	4" x 118"	A100	50

†Made-to-Order

# 3M™ Trizact™ Abrasive Belts

## 237AA (cont)

UPC	W x L	Grade	Qty/Case
051111-69251-6†	4" x 132"	A6	50
051111-69017-8	4" x 132"	A16	50
051111-51214-2	4" x 132"	A30	50
051111-69031-4†	4" x 132"	A45	50
051111-69387-2†	4" x 132"	A65	50
051111-66941-9†	4" x 132"	A80	50
051111-69048-2†	4" x 132"	A100	50
051115-27521-0†	4" x 168"	A16	50
051119-10264-2†	4" x 168"	A30	50
051119-08908-0†	4" x 168"	A65	50
051115-27303-2†	4" x 352"	A160	50
051115-27467-1†	4" x 354"	A65	50
051111-68739-0†	4" x 354"	A100	20
051111-68738-3†	4" x 354"	A160	50

†Made-to-Order

## 253FA

- Ideal for wet flat-finishing and wet intermediate finishing of centerless applications
- Great on stainless steel, carbon steel and carbon fiber composites



UPC	W x L	Grade	Qty/Case
051125-71939-1	Belt sizes made to order; specify UPC, grade and belt size (W" x L"); belts wider than 25" require multiple splices	A6	Determined by belt size
051125-71940-7		A16	
051125-71941-4		A30	
051125-71942-1		A45	
051125-71943-8		A65	
051125-71944-5		A80	
051125-71945-2		A100	

## 307EA

- Flexible cloth backing
- Aluminum oxide mineral
- Perfect choice for preplate surface finishes



UPC	W x L	Grade	Qty/Case
051111-67100-9†	1" x 42"	A80	200
051111-69408-4†	1" x 42"	A100	200
051115-27448-0†	1" x 72"	A45	200
051125-14659-3†	1" x 72"	A65	200
051119-63318-4†	1" x 76"	A6	200
051125-50495-9†	1" x 76"	A30	200
051115-19520-4†	1" x 77"	A45	200
051115-26828-1†	1" x 132"	A6	200
051115-27410-7†	1" x 132"	A16	200
051115-27346-9†	1" x 132"	A45	200

†Made-to-Order

## 307EA (cont)

UPC	W x L	Grade	Qty/Case
051115-27830-3†	2" x 36"	A16	50
051125-40962-9†	2" x 48"	A65	50
051119-58606-0†	2" x 60"	A30	50
051119-75663-0†	2" x 60"	A45	50
051125-46217-4†	2" x 60"	A65	50
051125-11024-2	2" x 72"	A6	50
051111-69061-1	2" x 72"	A16	50
051111-69067-3	2" x 72"	A30	50
051111-69072-7†	2" x 72"	A45	50
051111-69074-1†	2" x 72"	A65	50
051111-69079-6	2" x 72"	A100	50
051125-34816-4	2" x 76"	A30	50
051111-61066-4	2" x 83"	A16	200
051115-27125-0†	2" x 90"	A16	50
051119-09343-8†	2" x 118"	A16	50
051125-20950-2†	2" x 118"	A30	50
051125-20345-6†	2" x 118"	A45	50
051111-51206-7	2" x 132"	A6	50
051111-51202-9	2" x 132"	A16	50
051111-69068-0	2" x 132"	A30	50
051111-51210-4	2" x 132"	A45	50
051111-69075-8	2" x 132"	A65	50
051111-69077-2	2" x 132"	A80	50
051111-69080-2	2" x 132"	A100	50
051111-67059-0†	2" x 148"	A6	50
051115-19517-4†	2" x 148"	A16	50
051125-20168-1†	2" x 148"	A45	50
051115-27893-8†	3" x 72"	A16	50
051125-38992-1†	3" x 72"	A30	50
051125-30837-3†	3" x 72"	A100	50
051125-49713-8†	3" x 90"	A65	50
051111-67077-4†	3" x 96"	A30	50
051111-69256-1†	3" x 96"	A65	50
051111-68819-9†	3" x 118"	A6	50
051111-69063-5†	3" x 118"	A16	50
051111-51203-6	3" x 118"	A30	50
051111-67084-2†	3" x 118"	A45	50
051111-67106-1†	3" x 118"	A80	50
051111-67111-5†	3" x 118"	A100	50
051115-27418-3†	3" x 120"	A16	50
051125-20567-2†	3" x 120"	A30	50
051125-30879-3†	3" x 120"	A45	50
051111-69059-8†	3" x 132"	A6	50
051111-51200-5	3" x 132"	A16	50
051111-51201-2	3" x 132"	A30	50
051111-69073-4	3" x 132"	A45	50
051111-69076-5†	3" x 132"	A65	50
051111-69078-9	3" x 132"	A80	50
051111-69082-6†	3" x 132"	A100	50

†Made-to-Order

Chart continued on next page

# 3M™ Trizact™ Cloth Belts

## 307EA (cont)

UPC	W x L	Grade	Qty/Case
051115-27604-0†	4" x 36"	A30	50
051111-69060-4†	4" x 90"	A6	50
051111-69064-2†	4" x 90"	A16	50
051125-22401-7†	4" x 118"	A6	50
051111-69065-9	4" x 118"	A16	50
051111-69070-3†	4" x 118"	A30	50
051111-67107-8†	4" x 118"	A80	50
051111-67112-2†	4" x 118"	A100	50
051115-27766-5†	4" x 132"	A6	50
051111-69066-6†	4" x 132"	A16	50
051111-69071-0	4" x 132"	A30	50
051111-68821-2†	4" x 168"	A30	50
051115-26997-4†	4" x 240"	A16	25
051111-67113-9†	4" x 240"	A100	50

†Made-to-Order

## 327DC

- Use for mill line removal, intermediate scratch refinement, consistent dimensioning and consistent finishing applications
- Macroreplicated aluminum oxide on a flexible backing
- Grinding aid
- For dry, low pressure applications only



UPC	W x L	Grade	Qty/Case
076308-66875-4	Belt sizes made to order; specify UPC, grade and belt size (W" x L")	A30	Determined by belt size
051125-71755-7		A45	
076308-66873-0		A65	
076308-66877-8		A100	
076308-66779-5		A160	
051125-71753-3		A300	

## 337DC

- Macroreplicated structure provides long product life and consistent cut and finish
- For dry, medium pressure applications on backstand grinders



UPC	W x L	Grade	Qty/Case
048011-33154-6†	2" x 60"	A100	5
048011-33153-9†	2" x 60"	A160	5
048011-33152-2†	2" x 60"	A300	5
048011-33161-4†	2" x 72"	A45	20
048011-33160-7†	2" x 72"	A65	5
048011-33159-1†	2" x 72"	A100	5
048011-33158-4†	2" x 72"	A160	5
048011-33157-7†	2" x 72"	A300	5
048011-33166-9†	2" x 132"	A45	5
048011-33165-2†	2" x 132"	A65	5
048011-33164-5†	2" x 132"	A100	5
048011-33163-8†	2" x 132"	A160	5
048011-33162-1†	2" x 132"	A300	5
048011-33171-3†	3" x 132"	A45	5
048011-33170-6†	3" x 132"	A65	5
048011-33169-0†	3" x 132"	A100	5
048011-33168-3†	3" x 132"	A160	5
048011-33167-6†	3" x 132"	A300	5

†Made-to-Order

## 347FC

- 3M aluminum oxide abrasive grain on a macroreplicated, flexible X wt backing
- For wet, high-pressure applications on hard metals, nickel alloys, titanium and stainless steel



UPC	W x L	Grade	Qty/Case
076308-67648-3	Belt sizes made to order; specify UPC, grade and belt size (W" x L")	A30	Determined by belt size
076308-67649-0		A45	
076308-67650-6		A65	
076308-67651-3		A100	
076308-67652-0		A160	
076308-67653-7		A300	

## 3M™ Trizact™ Cloth Belts

### 407EA

- Use for mill line removal, intermediate scratch refinement, consistent dimensioning and consistent finishing applications
- Silicon carbide constructed on a flexible rayon cloth backing
- Grinding aid for cooler grinding
- Resin bonded for heat resistance



UPC	W x L	Grade	Qty/Case
051125-71792-2	Belt sizes made to order; specify UPC, grade and belt size (W" x L")	A20	Determined by belt size
051125-71793-9		A60	
051125-71794-6		A90	
051125-71795-3		A110	

### 953FA

- Use in wet centerless or flat grinding and finishing operations
- Process flexible belt that delivers consistent, predictable results
- Macroreplicated ceramic abrasive grain coated on waterproof cloth backing



UPC	W x L	Grade	Qty/Case
051125-71978-0	Belt sizes made to order; specify UPC, grade and belt size (W" x L"); belts wider than 25" require multiple splices	A6	Determined by belt size
051125-71989-6		A10	
051125-71979-7		A16	
051125-71980-3		A30	
051125-71981-0		A45	
051125-71982-7		A65	
051125-71983-4		A80	
051125-71984-1		A100	
051125-71986-5		A160	
051125-71988-9		A300	

## 3M™ Belts

### 384F

- Workhorse for general purpose metalworking applications
- Consistent performance on all metals at a great value
- Waterproof X wt polyester backing
- Available in grades 36+ to 240+; P320-400



UPC	Size	Grade	Qty/Case
076308-47073-9	1/2" x 18"	36+	200
076308-45587-3		60+	
076308-45588-0		80+	
076308-45586-6†		120+	
076308-47069-2	1/2" x 24"	36+	200
076308-47070-8		60+	
076308-47071-5		80+	
051125-87318-5		120+	
076308-47072-2	3/4" x 18"	36+	200
076308-45583-5		60+	
076308-45584-2		80+	
076308-45585-9†		120+	
076308-45579-8†	1" x 42"	80+	200
076308-45580-4		120+	
076308-45575-0	2" x 60"	60+	50
076308-45574-3†		80+	
076308-45581-1	6" x 48"	60+	20
076308-45582-8		80+	
076308-45573-6†	6" x 264"	80+	20
076308-45577-4	37" x 60"	80+	5
076308-45576-7		120+	
076308-47067-8†		150+	
076308-47065-4†		180+	
076308-45578-1†	37" x 75"	120+	5
076308-47059-3†	2" x 132"	36+	50
076308-47060-9		60+	
076308-47061-6†	3" x 132"	36+	50
076308-47063-0		60+	
076308-47064-7†		80+	
076308-68116-6*	Custom sizes	36+	Determined by belt size
076308-68118-0*		50+	
076308-68119-7*		60+	
076308-68120-3*		80+	
076308-68122-7*		120+	
076308-68123-4*		150+	
076308-68124-1*		180+	
076308-68236-1*		220+	
076308-68125-8*		240+	
076308-68126-5*		P320	
076308-68127-2*		P400	

Available in grades 36+ to 400+  
 \*3M ID — Custom size made to order

## 3M™ Belts

### 302D

- Aluminum oxide mineral
- Flexible belt for blending and finishing contoured and complex parts
- Works great on most metals
- For use on backstand grinders
- Grades 60, 80, P100–P600



UPC	W x L	Grade	Qty/Case
051141-30867-8†	2" x 118"	P120	25
051141-30870-8†	2" x 118"	P150	25
051141-30885-2†	2" x 118"	P320	25
051141-30888-3†	2" x 118"	P400	25
051141-30710-7	2" x 132"	80	50
051141-30713-8	2" x 132"	P100	50
051141-30716-9	2" x 132"	P120	50
051141-30719-0	2" x 132"	P150	50
051141-30722-0	2" x 132"	P180	50
051141-30725-1	2" x 132"	P220	25
051141-30728-2	2" x 132"	P240	50
051141-30734-3	2" x 132"	P320	50
051141-30737-4	2" x 132"	P400	50
051141-30862-3†	3" x 118"	80	25
051141-30877-7†	3" x 118"	P220	25
051141-30886-9†	3" x 118"	P320	25
051141-30780-0†	3" x 132"	60	50
051141-30711-4	3" x 132"	80	50
051141-30714-5	3" x 132"	P100	50
051141-30717-6	3" x 132"	P120	50
051141-30720-6	3" x 132"	P150	50
051141-30723-7	3" x 132"	P180	50
051141-30726-8	3" x 132"	P220	50
051141-30729-9	3" x 132"	P240	25
051141-30732-9	3" x 132"	P280	50
051141-30735-0	3" x 132"	P320	50
051141-30738-1	3" x 132"	P400	50

†Made-to-Order

### 332D

- Aluminum oxide mineral
- Semi-flexible X wt backing provides good durability when working on contoured parts
- For use on backstand grinders
- Works great on most metals
- Grades 60, 80, P100–P400



UPC	W x L	Grade	Qty/Case
051141-30746-6	2" x 132"	80	25
051141-30752-7†	2" x 132"	P120	25
051141-30758-9	2" x 132"	P180	50
051141-30761-9	2" x 132"	P220	50
051141-30764-0	2" x 132"	P240	50
051141-30750-3	3" x 132"	P100	50
051141-30753-4†	3" x 132"	P120	50
051141-30756-5	3" x 132"	P150	50
051141-30759-6	3" x 132"	P180	50
051141-30762-6	3" x 132"	P220	50
051141-30765-7	3" x 132"	P240	50

†Made-to-Order

## 3M™ Belts

### 341D

- Aluminum oxide on an X wt cloth backing
- Excellent all-around abrasive belt for blending and finishing
- For use on backstand, benchtop, stroke sanding, slack of belt and dry flat finishing equipment



UPC	W x L	Grade	Qty/Case
051144-26614-2	1" x 42"	36	200
051144-31823-0	1" x 42"	50	200
051144-26602-9†	1" x 42"	P150	200
051144-26601-2	1" x 42"	P180	200
051144-26599-2	1" x 42"	P240	200
051144-26597-8	1" x 42"	P320	200
051144-26443-8†	1-1/2" x 60"	36	50
051144-26441-4†	1-1/2" x 60"	40	50
051144-26438-4	1-1/2" x 60"	60	50
051144-26436-0	1-1/2" x 60"	80	50
051144-26571-8	2" x 48"	36	50
051144-26568-8	2" x 48"	50	50
051144-26564-0	2" x 48"	60	50
051144-26562-6	2" x 48"	80	50
051144-26561-9†	2" x 48"	P100	50
051144-26560-2	2" x 48"	P120	50
051144-26424-7†	2" x 60"	50	50
051144-33640-1	2" x 60"	60	50
051144-33639-5	2" x 60"	80	50
051144-33667-8	2" x 60"	P120	50
051144-26320-2	2" x 72"	36	50
051144-26316-5	2" x 72"	60	50
051144-33067-6	2" x 72"	80	50
051144-26312-7	2" x 72"	P120	50
051144-26309-7	2" x 72"	P180	50
051144-81752-8	2" x 72"	P240	50
051144-26408-7	2-1/2" x 60"	36	50
051144-26400-1	2-1/2" x 60"	60	50
051144-26396-7	2-1/2" x 60"	80	50
051144-26388-2	2-1/2" x 60"	P120	50
051144-26857-3	3-1/2" x 15-1/2"	60	50
051144-26856-6	3-1/2" x 15-1/2"	80	50
051144-33647-0	4" x 132"	60	25
051144-26517-6	6" x 48"	P150	20
051144-26515-2	6" x 48"	P180	20
051144-26513-8	6" x 48"	P240	20
051144-74271-4	37" x 60"	P120	5
051144-14420-4	37" x 75"	80	3
051144-33061-4	37" x 75"	P120	5

†Made-to-Order

### 361F

- Aluminum oxide on an XF wt backing
- Durable belt with a tough polyester backing that can be used wet or dry
- Ideal use in the grinding of sheets and coils, centerless, flat finishing and hand tool applications



UPC	W x L	Grade	Qty/Case
051111-67159-7†	4" x 90"	P180	50
051111-67179-5†	4" x 90"	P320	50
051115-27707-8†	6" x 90"	P220	20
051144-14773-1	37" x 60"	80	2
051144-14905-6	37" x 60"	P100	5
051144-11519-8	37" x 60"	P120	5
051144-76939-1	37" x 60"	P150	5
051144-11515-0	37" x 60"	P180	5
051144-76923-0	37" x 60"	P220	5
051144-81215-8	37" x 75"	P100	5
051144-76942-1†	37" x 75"	P120	5
051144-80037-7	37" x 75"	P150	5
051111-51215-9	37" x 75"	P180	5

†Made-to-Order

### 461F

- Silicon carbide mineral
- Durable cloth-backed belts
- For heavy duty grinding to fine finishing
- Resistant to tearing and will not easily nick
- For use on backstand, benchtop, slack of belt, flat finishing, centerless and wet roll grinding equipment



UPC	W x L	Grade	Qty/Case
051111-67404-8†	4" x 118"	P220	50
051111-67405-5†	4" x 132"	P220	50
051111-67408-6†	4" x 132"	P320	50

†Made-to-Order

## 3M™ Belts

### 577F

- Alumina zirconia on a YF wt cloth backing
- Resin bonded for heat resistance
- Features a grinding aid for cooler grinding
- For use on backstand, benchtop, slack of belt, portable, flat finishing, centerless and roll grinding equipment
- Can be run wet or dry



UPC	W x L	Grade	Qty/Case
051141-30690-2	1/4" x 18"	60	200
051141-30691-9	1/4" x 18"	80	200
051141-30708-4	1/4" x 18"	120	200
051141-30694-0	1/4" x 24"	60	200
051119-05580-1	1/4" x 24"	80	200
051141-30695-7	1/4" x 24"	120	200
051111-68668-3	1/2" x 12"	60	200
051111-68695-9	1/2" x 12"	80	200
051141-30709-1	1/2" x 12"	120	200
051141-30686-5	1/2" x 18"	36	200
051119-63081-7	1/2" x 18"	60	200
051119-82035-5	1/2" x 18"	80	200
051141-30689-6	1/2" x 18"	120	200
051141-30693-3	1/2" x 24"	36	200
051111-68669-0	1/2" x 24"	60	50
051111-68696-6	1/2" x 24"	80	200
051111-69436-7	1/2" x 24"	120	200
051141-30687-2	3/4" x 18"	36	200
051115-19553-2	3/4" x 18"	60	200
051125-19076-3	3/4" x 18"	80	200
051141-30688-9	3/4" x 18"	120	200
051125-16745-1	3/4" x 20-1/2"	60	50
051111-68697-3	3/4" x 20-1/2"	80	200
051125-22333-1	3/4" x 20-1/2"	120	200
051119-71425-8	1" x 18"	60	200
051125-23878-6	1" x 18"	80	200
051141-30692-6	1" x 18"	120	200
051115-19554-9	2" x 48"	60	50
051119-05579-5	2" x 48"	80	50
051125-11238-3	2" x 48"	120	50
051141-30699-5	2" x 60"	36	50
051111-69103-8	2" x 60"	60	50
051141-30703-9	2" x 60"	80	50
051141-30704-6	2" x 60"	120	50
051141-30698-8	2" x 72"	36	50
051111-69104-5	2" x 72"	60	50
051141-30701-5	2" x 72"	80	50
051141-30697-1	2" x 72"	120	50

### 577F (cont)

UPC	W x L	Grade	Qty/Case
051111-67602-8	2" x 132"	36	10
051141-30702-2	2" x 132"	50	50
051111-69105-2	2" x 132"	60	50
051111-69108-3	2" x 132"	80	50
051141-30696-4	2" x 132"	120	50
051119-64999-4	2-1/2" x 60"	36	50
051111-69106-9	2-1/2" x 60"	60	50
051125-12707-3	2-1/2" x 60"	80	50
051141-30706-0	2-1/2" x 60"	120	25
051111-69099-4	3" x 132"	36	5
051119-82066-9	3" x 132"	50	25
051111-69569-2	3" x 132"	60	25
051111-69571-5	3" x 132"	80	25
051111-67681-3	3" x 132"	120	50
051119-67701-0†	3-1/2" x 15-1/2"	60	50
051119-58968-9†	3-1/2" x 15-1/2"	80	50
051119-67700-3†	3-1/2" x 15-1/2"	120	50
051111-67604-2	4" x 132"	36	25
051115-27562-3	4" x 132"	50	25
051111-69570-8	4" x 132"	60	25
051111-69573-9	4" x 132"	80	25
051125-23987-5	4" x 132"	120	25
051111-69445-9	6" x 48"	60	20
051119-83855-8	6" x 48"	80	20
051141-30707-7	6" x 48"	120	20
051111-69440-4	37" x 60"	36	2
051111-68691-1	37" x 60"	60	2
051111-69111-3	37" x 60"	80	2
051111-69115-1	37" x 60"	120	5
051125-22740-7	37" x 60"	180	5
051119-61101-4	37" x 75"	36	2
051111-68692-8	37" x 75"	60	2
051111-69112-0	37" x 75"	80	2
051111-67688-2	37" x 75"	120	5
051125-09283-8	37" x 75"	180	5

†Made-to-Order

## 3M™ Belts

### 747D

- 3M ceramic aluminum oxide blend abrasive grain on an X wt cloth backing
- Use for offhand heat sensitive stainless steel applications
- Grinding aid enhances performance on stainless steel and other exotic alloys
- Well suited for stroke sanding applications



UPC	W x L	Grade	Qty/Case
051111-67749-0†	3" x 9-1/2"	50	200
051111-67759-9†	3" x 9-1/2"	60	200
051111-67789-6†	3" x 9-1/2"	P100	200
051111-67806-0†	3" x 9-1/2"	P120	200
051111-67807-7†	3" x 118"	P120	50
051115-27355-1†	3" x 132"	60	50
051111-67751-3†	6" x 264"	50	10
051111-67766-7†	6" x 264"	60	10
051111-67778-0†	6" x 264"	80	20
051125-20535-1†	6" x 264"	P100	20
051111-67812-1†	6" x 264"	P120	20
051144-85846-0†	6" x 274"	60	20
051111-67779-7†	6" x 274"	80	20
051111-67781-0†	6" x 300"	80	20
051111-67813-8†	6" x 300"	P120	20
051115-19560-0†	6" x 355"	50	10

†Made-to-Order

### 777F

- 3M ceramic aluminum oxide blend abrasive grain on a YF wt cloth backing
- Contains grinding aid which enhances performance on stainless steel and other exotic alloys
- For use on backstand, benchtop, flat finishing, slack of belt, centerless and dry roll grinding equipment
- Can be run wet or dry



UPC	W x L	Grade	Qty/Case
051144-84403-6	1/4" x 18"	60	200
051144-85318-2	1/4" x 18"	80	200
051144-84412-8	1/4" x 24"	40	200
051144-80253-1	1/4" x 24"	60	200
051144-77642-9	1/4" x 24"	80	200
051144-82229-4	1/4" x 24"	P120	200
051111-69457-2	1/2" x 12"	60	200
051144-85372-4	1/2" x 12"	80	200
051111-69604-0	1/2" x 12"	P120	200
051144-84301-5	1/2" x 18"	36	200
051144-84409-8	1/2" x 18"	40	200
051144-80551-8	1/2" x 18"	60	200
051144-80232-6	1/2" x 18"	80	200
051144-84304-6	1/2" x 18"	P120	200
051144-77643-6	1/2" x 24"	36	200
051144-82342-0	1/2" x 24"	40	200
051144-77408-1	1/2" x 24"	50	200
051144-77065-6	1/2" x 24"	60	200
051144-77491-3	1/2" x 24"	80	200
051144-81064-2	1/2" x 24"	P120	200
051144-84302-2	3/4" x 18"	36	200
051144-84404-3	3/4" x 18"	60	200
051144-77992-5	3/4" x 18"	80	200
051144-84303-9	3/4" x 18"	P120	200
051144-80486-3	3/4" x 20-1/2"	60	200
051144-80686-7	3/4" x 20-1/2"	80	200
051125-23897-7	1" x 18"	60	200
051144-85319-9	1" x 18"	80	200
051141-30705-3	1" x 18"	P120	200
051144-76527-0	1" x 42"	40	200
051144-77512-5	1" x 42"	60	200
051144-14895-0	1" x 42"	80	200
051144-84416-6	1-1/2" x 60"	60	50
051144-76731-1	1-1/2" x 60"	80	50
051144-82022-1	1-1/2" x 60"	P120	50
051144-76738-0	2" x 48"	36	50
051144-76519-5	2" x 48"	60	50
051144-14896-7	2" x 48"	80	50
051144-85393-9	2" x 48"	P120	50

Chart continued on next page

## 3M™ Belts

### 777F (cont)

UPC	W x L	Grade	Qty/Case
051144-77663-4	2" x 60"	36	50
051144-77152-3	2" x 60"	60	50
051144-84296-4	2" x 60"	80	50
051144-85377-9	2" x 60"	P120	50
051144-76531-7	2" x 72"	36	50
051144-80286-9	2" x 72"	60	50
051144-14884-4	2" x 72"	80	50
051144-81767-2	2" x 72"	P120	50
051144-14264-4	2" x 132"	36	50
051144-14899-8	2" x 132"	50	50
051144-82231-7	2" x 132"	60	50
051144-14534-8	2" x 132"	80	50
051144-81687-3	2" x 132"	P120	50
051144-76532-4	2-1/2" x 60"	36	50
051144-76680-2	2-1/2" x 60"	60	50
051144-76686-4	2-1/2" x 60"	80	50
051115-27389-6	2-1/2" x 60"	P120	50
051144-76533-1	3" x 132"	36	25
051111-69455-8	3" x 132"	50	25
051144-76520-1	3" x 132"	60	25
051144-76514-0	3" x 132"	80	25
051144-80028-5	3" x 132"	P120	50
051144-77336-7	3-1/2" x 15-1/2"	36	50
051144-77334-3	3-1/2" x 15-1/2"	50	50
051144-77476-0	3-1/2" x 15-1/2"	60	50
051144-77333-6	3-1/2" x 15-1/2"	80	50
051144-84306-0	3-1/2" x 15-1/2"	100	50
051144-84307-7	3-1/2" x 15-1/2"	P120	50
051144-85320-5	3-1/2" x 15-1/2"	P180	50
051111-67851-0	4" x 132"	50	25
051144-80707-9	4" x 132"	60	25
051144-76515-7	4" x 132"	80	25
051141-30700-8†	4" x 132"	P120	25
051144-82313-0	6" x 48"	36	20
051144-80176-3	6" x 48"	50	20
051144-76679-6	6" x 48"	60	20
051144-76733-5	6" x 48"	80	20
051144-82153-2	6" x 48"	P120	20
051125-33828-8	37" x 60"	36	2
051115-27354-4	37" x 60"	60	2

†Made-to-Order

# Scotch-Brite™ Surface Conditioning Belts

The easiest way to a perfect finish. Choose Scotch-Brite™ Surface Conditioning Belts for cleaning, finishing, blending and deburring. The reinforced backing offers good flexibility whether working on a file belt or backstand. The non-woven material combined with abrasive grain is an ideal way to add a great finish or remove burrs without gouging or undercutting the work piece. Trust Scotch-Brite™ Belts to deliver fantastic finishes.

## Choose the Right Belt for the Job Scotch-Brite™ Surface Conditioning Belt Guide

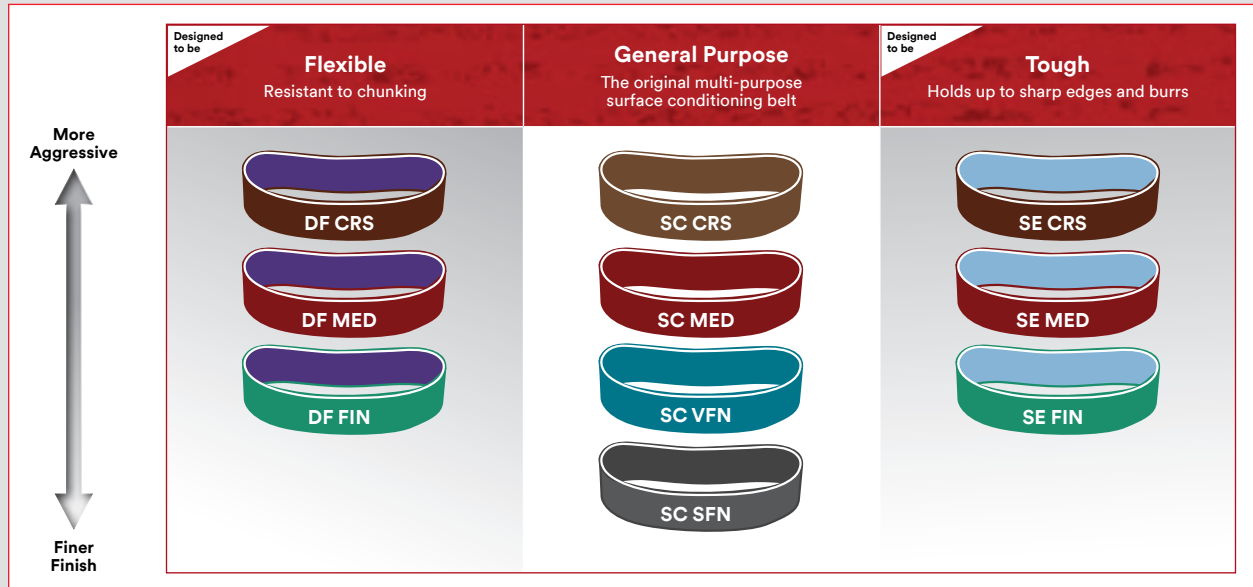

Recommended Backings		File Belt	In-Line Sander	Stroke Sander	Back Stand	Centerless/Cylindrical	Flat Finishing
Scotch-Brite™ DF Surface Conditioning Belt	Low Stretch	◆	□		◆	◆	□
	Scrim	□	◆				
Scotch-Brite™ SC Surface Conditioning Belt	Low Stretch				□	□	◆
	Film Backed			◆			
Scotch-Brite™ SE Surface Conditioning Belt	Scrim	□	□				
	Low Stretch				□	□	□
	Film Backed			□			

◆ = Recommended Starting Point  
□ = Recommended Alternative

### Scotch-Brite™ Belts Recommended operating speeds

Application	Recommended SFPM
Decorative Finishing	500–3,000 SFPM
Deburring	5,000–6,500 SFPM
Cleaning and Conditioning	2,000–5,000 SFPM
Oxide Removal	4,500–6,500 SFPM

Maximum Operating Speed: 6,500 SFPM  
SFPM = Surface Feet Per Minute

# Scotch-Brite™ Surface Conditioning Belts

## Scotch-Brite™ SC Surface Conditioning Belts

- Premium Scotch-Brite surface conditioning non-woven web
- Designed for cleaning, finishing and light deburring
- For use on portable, benchtop and backstand equipment



UPC	W x L	Grade	Color	Qty/Case
048011-13290-7†	1/4" x 18"	A CRS	Brown	20
048011-14276-0	1/4" x 18"	A MED	Maroon	20
048011-13230-3†	1/4" x 18"	A VFN	Blue	20
048011-13132-0	1/4" x 24"	A CRS	Brown	20
048011-13131-3	1/4" x 24"	A MED	Maroon	20
048011-13287-7	1/4" x 24"	A VFN	Blue	20
048011-08858-7	1/2" x 18"	A CRS	Brown	20
048011-08857-0	1/2" x 18"	A MED	Maroon	20
048011-08856-3	1/2" x 18"	A VFN	Blue	20
048011-05741-5	1/2" x 24"	A CRS	Brown	20
048011-03998-5	1/2" x 24"	A MED	Maroon	20
048011-04299-2	1/2" x 24"	A VFN	Blue	20
048011-13639-4	3/4" x 18"	A CRS	Brown	20
048011-15899-0	3/4" x 18"	A MED	Maroon	20
048011-14543-3	3/4" x 18"	A VFN	Blue	20
048011-14278-4	1" x 18"	A CRS	Brown	10
048011-14398-9†	1" x 18"	A MED	Maroon	10
048011-17517-1†	1" x 18"	A VFN	Blue	10
048011-04189-6	1" x 42"	A MED	Maroon	10
048011-04190-2	1" x 42"	A VFN	Blue	10
048011-08913-3†	1" x 132"	A MED	Maroon	5
048011-08915-7	2" x 48"	A MED	Maroon	10
048011-04295-4	2" x 48"	A VFN	Blue	10
048011-08883-9†	2" x 72"	A CRS	Brown	10
048011-00580-5	2" x 72"	A MED	Maroon	10
048011-00579-9	2" x 72"	A VFN	Blue	10
048011-03999-2	2" x 132"	A MED	Maroon	5
048011-04297-8	2" x 132"	A VFN	Blue	5
048011-05022-5	2-3/4" x 15-1/2"	A CRS	Brown	10
048011-05227-4	2-3/4" x 15-1/2"	A MED	Maroon	10
048011-05820-7	3" x 10-11/16"	A CRS	Brown	10
048011-05783-5	3" x 10-11/16"	A MED	Maroon	10
048011-09650-6	3" x 10-11/16"	A VFN	Blue	10
048011-14284-5†	3" x 18"	A CRS	Brown	10
048011-14285-2	3" x 18"	A MED	Maroon	10
048011-14550-1	3" x 18"	A VFN	Blue	10

†Made-to-Order

## Scotch-Brite™ SC Surface Conditioning Belts (cont)

UPC	W x L	Grade	Color	Qty/Case
048011-08880-8	3" x 24"	A CRS	Brown	10
048011-00583-6	3" x 24"	A MED	Maroon	10
048011-04298-5	3" x 24"	A VFN	Blue	10
048011-05023-2	3" x 132"	A CRS	Brown	5
048011-00568-3	3" x 132"	A MED	Maroon	5
048011-04289-3	3" x 132"	A VFN	Blue	5
048011-05016-4	3-1/2" x 15-1/2"	A CRS	Brown	10
048011-05228-1	3-1/2" x 15-1/2"	A MED	Maroon	10
048011-05643-2	3-1/2" x 15-1/2"	A VFN	Blue	10
048011-08882-2†	4" x 24"	A CRS	Brown	10
048011-00585-0†	4" x 24"	A MED	Maroon	10
048011-05018-8†	4" x 132"	A CRS	Brown	5
048011-00570-6	4" x 132"	A MED	Maroon	5
048011-04281-7	4" x 132"	A VFN	Blue	5
048011-05019-5	6" x 48"	A CRS	Brown	5
048011-00590-4	6" x 48"	A MED	Maroon	5
048011-04283-1	6" x 48"	A VFN	Blue	5

†Made-to-Order

## Scotch-Brite™ Durable Flex (DF) Surface Conditioning Belts

- Durable flex belt has great edge durability
- Aggressive and long lasting belt for deburring, finishing, blending and cleaning
- The reinforced low-stretch backing offers good flexibility

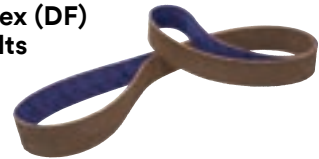

UPC	W x L	Grade	Color	Qty/Case
048011-64472-1	1/4" x 18"	A CRS	Brown	20
048011-64455-4	1/4" x 18"	A MED	Maroon	20
048011-64464-6	1/4" x 18"	A FIN	Green	20
048011-64473-8	1/4" x 24"	A CRS	Brown	20
048011-64456-1	1/4" x 24"	A MED	Maroon	20
048011-64465-3	1/4" x 24"	A FIN	Green	20
048011-64474-5†	1/2" x 12"	A CRS	Brown	20
048011-64457-8	1/2" x 12"	A MED	Maroon	20
048011-64466-0†	1/2" x 12"	A FIN	Green	20
048011-64475-2	1/2" x 18"	A CRS	Brown	20
048011-64458-5	1/2" x 18"	A MED	Maroon	20
048011-64467-7	1/2" x 18"	A FIN	Green	20
048011-64476-9	1/2" x 24"	A CRS	Brown	20
048011-64459-2	1/2" x 24"	A MED	Maroon	20
048011-64468-4	1/2" x 24"	A FIN	Green	20

†Made-to-Order

**Attention:** Belts are available in other grades and sizes. If you need a specific belt not listed, contact your 3M Sales Specialist or 3M Authorized Distributor.

# Scotch-Brite™ Surface Conditioning Belts

## Scotch-Brite™ Durable Flex (DF) Surface Conditioning Belts (cont)

UPC	W x L	Grade	Color	Qty/Case
048011-64477-6	3/4" x 18"	A CRS	Brown	20
048011-64460-8	3/4" x 18"	A MED	Maroon	20
048011-64469-1	3/4" x 18"	A FIN	Green	20
048011-64480-6+	3" x 10-11/16"	A MED	Maroon	10
048011-64488-2+	3" x 18"	A CRS	Brown	10
048011-64483-7	3" x 18"	A MED	Maroon	10
048011-64487-5+	3" x 24"	A CRS	Brown	10
048011-64481-3+	3" x 24"	A MED	Maroon	10
048011-64479-0+	3" x 132"	A CRS	Brown	5
048011-64462-2	3" x 132"	A MED	Maroon	5
048011-64478-3	3-1/2" x 15-1/2"	A CRS	Brown	10
048011-64461-5	3-1/2" x 15-1/2"	A MED	Maroon	10
048011-64470-7+	3-1/2" x 15-1/2"	A FIN	Green	10

†Made-to-Order

## Scotch-Brite™ SE Surface Conditioning Belts

- Coarse, tough, aggressive non-woven belt for heavy duty deburring and finishing
- For use on backstand and off hand equipment
- Reinforced backing offers good flexibility
- Abrasive mineral: coarse grade aluminum oxide

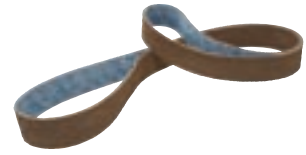

UPC	W x L	Grade	Color	Qty/Case
048011-18495-1	1/4" x 18"	A CRS	Brown/Blue	20
048011-18496-8+	1/4" x 24"	A CRS	Brown/Blue	20
048011-18087-8	1/2" x 18"	A CRS	Brown/Blue	20
048011-18480-7	1/2" x 18"	A MED	Maroon/Blue	20
048011-30006-1	1/2" x 18"	A FIN	Green/Blue	20
048011-18088-5	1/2" x 24"	A CRS	Brown/Blue	20
048011-18479-1	1/2" x 24"	A MED	Maroon/Blue	20
048011-30007-8	1/2" x 24"	A FIN	Green/Blue	20
048011-19697-8	3/4" x 18"	A CRS	Brown/Blue	20
048011-18859-1	3/4" x 18"	A MED	Maroon/Blue	20
048011-18089-2	3-1/2" x 15-1/2"	A CRS	Brown/Blue	10
048011-18478-4	3-1/2" x 15-1/2"	A MED	Maroon/Blue	10
048011-30008-5	3-1/2" x 15-1/2"	A FIN	Green/Blue	10

†Made-to-Order

# 3M™ Power Tools: Abrasive Belt Systems

## 3M™ File Belt Sander and Kit

- Ideally suited for use with 3M™ Abrasive Belts and Scotch-Brite™ Belts for a variety of metalworking applications
- Grind and blend from contact wheel or platen finish and polish from slack of belt
- Provides access to hard-to-reach areas
- Eight different attachment arms available



UPC	Model	Motor	Max RPM	Belt Speed SFPM (SMM)	Weight Pound (kg)	Length Inch (mm)	Height Inch (mm)	Width Inch (mm)	Airflow Rate SCFM (LPM)
051141-28366-1	28366	0.6 HP	22,000	4990 (1521)	2.8 (1.3)	14.57 (370)	2.93 (74.5)	5.95 (151.2)	28 (793)
051141-28367-8	28367	<b>Kit includes:</b> Molded Case, File Belt Sander (PN28366) and two Attachment Arms (PNs 28368, 28370)							

**Attention:** Belts are available in other grades and sizes. If you need a specific belt not listed, contact your 3M Sales Specialist or 3M Authorized Distributor.

## Accessories: Abrasive Belt Systems

### 3M™ File Belt Sander Platen Pad Material

UPC	Part	Size	For Use With	Description	Qty/Case
051141-28377-7	28377	1/2" x 7" x 1/8"	1/2" wide belts	Soft	10
051141-28378-4	28378	3/4" x 7" x 1/8"	5/8" or 3/4" wide belts	Soft	10
051141-28379-1	28379	1/2" x 7" x 1/8"	1/2" wide belts	Hard	10
051141-28380-7	28380	3/4" x 7" x 1/8"	5/8" or 3/4" wide belts	Hard	10



### 3M™ File Belt Arm Service Tool Kit

UPC	Part	Description	Qty/Case
051141-30670-4	30670	Contains Wheel Positioning Block, Shaft Removal Tool, 2 Bearing Removal Tools, Bearing Mount Tool, Bearing Tool and Retaining Compound	1



### 3M™ File Belt Sander Attachment Arms

	UPC	Part	Use With Belt Size	Description	Qty/Case
	051141-28368-5	28368	1/2" x 18"	<b>Standard Style:</b> Standard arm included with 3M™ File Belt Sander (PN28366); sand with contact wheel or platen	1
	051141-28369-2	28369	1/2" x 18"	<b>Thin Style:</b> Thinner than standard arm; sand with contact wheel or platen	1
	051141-28370-8	28370	1/8" x 18" 1/4" x 18" 1/2" x 18"	<b>Corners Style:</b> Sand corners and grooves with contact wheel; accommodates three belt widths	1
	051141-28371-5	28371	5/8" x 18" 3/4" x 18"	<b>Thick Standard Style:</b> Thicker than standard arm; sand with contact wheel or platen; accommodates two belt widths	1
	051141-28372-2	28372	1/8" x 18" 1/4" x 18"	<b>Corners Style:</b> Sand corners and grooves with contact wheel; accommodates two belt widths	1
	051141-28374-6	28374	1/2" x 18"	<b>Curved Arm:</b> Unique curved arm used for blending flat areas; sand with contact wheel or platen	1
	051141-28375-3	28375	1/4" x 24" 1/2" x 24"	<b>Vessel Arm:</b> Unique large arm used for blending weld seams; sand with 4" contact wheel; includes tracking/control knob; accommodates two belt widths	1
	051141-28376-0	28376	1/2" x 24"	<b>Sander Extension:</b> Use to extend arms to 24" length; can be used with same attachment arm used for 18" length arms	1

### 3M™ File Belt Attachment Arm Repair Kits

Attachment Arm Repair Kit Part	Description	For Use With Attachment Arm Part
30663	<b>Kits contain:</b> Contact wheel, bearing, shaft and platen pad if applicable  3M™ File Belt Arm Service Tool Kit (PN30670) recommended for use with repair kits	28368
30667		28369
30668		28370
30664		28371
30666		28372
30662		28374
30669		28375

# Abrasive Wheel Systems

For Deburring, Weld Blending, Finishing and More!

## Scotch-Brite™ Convolute Wheels

Get high performance and durability in a variety of cleaning, deburring, finishing and polishing applications. Used on pedestal grinders, back stands, and bench motors, Scotch-Brite™ Wheels produce great results on all types of metal, composites and glass.

### Convolute Wheels Selection Guides

Scotch-Brite™ Convolute Wheel performance differences can be attributed to mineral (aggressiveness) and density (hardness). The combination of these two characteristics and subtle variations determine if the wheel will cut more aggressively or will be more durable and less conformable.

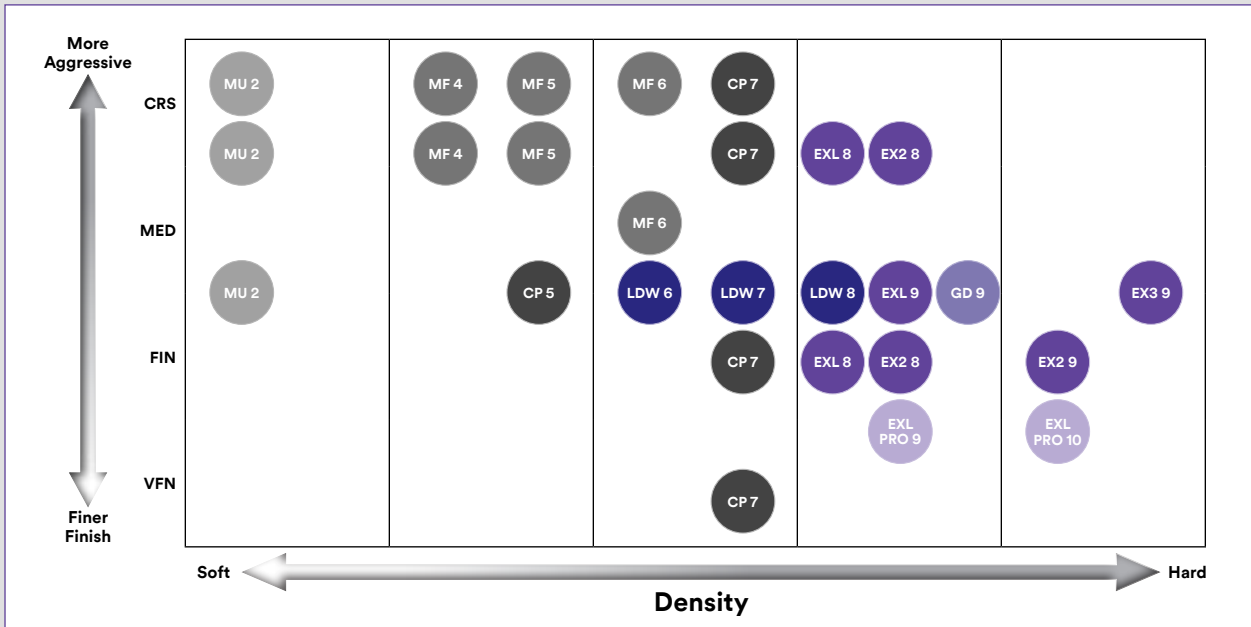

#### Mineral Abbreviations (prefix to grade)

A: Aluminum Oxide mineral    S: Silicon Carbide mineral

Scotch-Brite™ Convolute Wheel	Application				
	Cleaning	Deburring	Blending	Finishing	Polishing
3M™ General Deburring (GD)		•		•	
EXL/EX2/EX3 Deburring (EXL)		•	•	•	
Metal Finishing (MF)	•		•	•	
Cut and Polish (CP)			•	•	•
Multi-Finishing (MU)	•		•	•	
Light Deburring (LDW)				•	•
EXL-PRO Deburring (EXL PRO)		•			

## Scotch-Brite™ Convolute Wheels

### Scotch-Brite™ EXL-PRO Deburring Wheels

- Optimized performance, particularly in off-hand applications
- Longest life of any Scotch-Brite™ Deburring Wheel
- Smooth, even wear — helps control the workpiece
- More cut, with less pressure required — without sacrificing finish
- Easy to use, comfortable for operators



UPC	Dia x W x AH	Grade	Max RPM	Qty/Case
051125-94904-0	6" x 1/2" x 1"	9S FIN	6,000	4
051125-94905-7	6" x 1" x 1"	9S FIN	6,000	3
051125-94907-1	8" x 1/2" x 3"	9S FIN	4,500	4
051125-94908-8	8" x 1" x 3"	9S FIN	4,500	3
051125-94913-2	12" x 1" x 5"	9S FIN	3,000	1
051125-94914-9	12" x 2" x 5"	9S FIN	3,000	1
051125-94926-2	6" x 1/2" x 1"	10S FIN	6,000	4
051125-94917-0	6" x 1" x 1"	10S FIN	6,000	3
051125-94927-9	8" x 1/2" x 3"	10S FIN	4,500	4
051125-94918-7	8" x 1" x 3"	10S FIN	4,500	3
051125-94902-6	12" x 1" x 5"	10S FIN	3,000	1

Other sizes available in 9 and 10 densities.

### Scotch-Brite™ EXL, EX2 and EX3 Deburring Wheels

- Versatile wheel offers reliable performance and great value
- Full line of densities, grades and sizes for any deburring or finishing application
- Use to clean, finish, blend, deburr or polish all types of metals, composites and glass



UPC	Size	Grade	Max RPM	Qty/Case
EXL				
048011-13616-5	6" x 1/2" x 1"	8A MED	6,000	4
048011-09548-6	6" x 1/2" x 1"	8S FIN	6,000	4
048011-05790-3	6" x 1/2" x 1"	9S FIN	6,000	4
048011-13617-2	6" x 1" x 1"	8A MED	6,000	3
048011-18278-0	6" x 1" x 1"	8S MED	6,000	3
048011-09549-3	6" x 1" x 1"	8S FIN	6,000	3
048011-05132-1	6" x 1" x 1"	9S FIN	6,000	3
048011-13618-9	6" x 2" x 1"	8A MED	6,000	2
048011-05133-8	6" x 2" x 1"	9S FIN	6,000	2
048011-14791-8	8" x 3/8" x 3"	8S FIN	4,500	4
048011-17459-4	8" x 1/2" x 3"	8A MED	4,500	4
048011-14629-4	8" x 1/2" x 3"	8S FIN	4,500	4
048011-05791-0	8" x 1/2" x 3"	9S FIN	4,500	4
048011-13619-6	8" x 1" x 3"	8A MED	4,500	3
048011-18279-7	8" x 1" x 3"	8S MED	4,500	3
048011-09551-6	8" x 1" x 3"	8S FIN	4,500	3
048011-05135-2	8" x 1" x 3"	9S FIN	4,500	3
048011-13620-2	8" x 2" x 3"	8A MED	4,500	2
048011-09552-3	8" x 2" x 3"	8S FIN	4,500	2
048011-05136-9	8" x 2" x 3"	9S FIN	4,500	2

### Scotch-Brite™ EXL, EX2 and EX3 Deburring Wheels (cont)

UPC	Size	Grade	Max RPM	Qty/Case
EXL (cont)				
048011-05137-6	10" x 1" x 5"	9S FIN	3,600	2
048011-15641-5	12" x 1/2" x 5"	8S FIN	3,000	2
048011-09005-4	12" x 1/2" x 5"	9S FIN	3,000	2
048011-13621-9	12" x 1" x 5"	8A MED	3,000	1
048011-18281-0	12" x 1" x 5"	8S MED	3,000	1
048011-09554-7	12" x 1" x 5"	8S FIN	3,000	1
048011-05138-3	12" x 1" x 5"	9S FIN	3,000	1
048011-13622-6	12" x 2" x 5"	8A MED	3,000	1
048011-09555-4	12" x 2" x 5"	8S FIN	3,000	1
048011-05139-0	12" x 2" x 5"	9S FIN	3,000	1
048011-13623-3	14" x 2" x 8"	8A MED	2,550	1
048011-05141-3	14" x 2" x 8"	9S FIN	2,550	1
EX2				
048011-17215-6	6" x 1/2" x 1"	8A MED	6,000	4
048011-18285-8	6" x 1/2" x 1"	8S MED	6,000	4
048011-17216-3	6" x 1/2" x 1"	8S FIN	6,000	4
048011-24532-4	6" x 1/2" x 1"	9S FIN	6,000	4
048011-17217-0	6" x 1" x 1"	8A MED	6,000	3
048011-18286-5	6" x 1" x 1"	8S MED	6,000	3
048011-17218-7	6" x 1" x 1"	8S FIN	6,000	3
048011-18040-3	6" x 1" x 1"	9S FIN	6,000	3
048011-17426-6	8" x 1/2" x 3"	8A MED	4,500	4
048011-17425-9	8" x 1/2" x 3"	8S FIN	4,500	4
048011-17219-4	8" x 1" x 3"	8A MED	4,500	3
048011-17220-0	8" x 1" x 3"	8S FIN	4,500	3
048011-18365-7	8" x 1" x 3"	9S FIN	4,500	3
048011-17223-1*	12" x 1" x 5"	8A MED	3,000	1
048011-17224-8	12" x 1" x 5"	8S FIN	3,000	1
EX3				
048011-24026-8	6" x 1/2" x 1"	9S FIN	6,000	4
048011-18825-6	6" x 1" x 1"	9S FIN	6,000	3
048011-24527-0	8" x 1" x 3"	9S FIN	4,500	3
048011-18826-3	12" x 2" x 5"	9S FIN	3,000	1

\*Made-to-Order

### 3M™ General Deburring Wheels

- Soft construction for better conformability and more operator comfort
- For light or medium deburring, radiusing, finishing and cleaning applications
- Great price-value for general purpose needs
- All wheels are stocked and available in single package quantities



UPC	Dia x W x CH	Grade	Max RPM	Qty/Case
048011-64899-6	6" x 1/2" x 1"	9S FIN	6,000	5
048011-64900-9	6" x 1" x 1"	9S FIN	6,000	5
048011-64901-6	8" x 1/2" x 3"	9S FIN	4,500	5
048011-64902-3	8" x 1" x 3"	9S FIN	4,500	5

**Attention:** Wheels are available in other grades and sizes. If you need a specific wheel not listed, contact your 3M Sales Specialist or 3M Authorized Distributor.

# Scotch-Brite™ Convolute Wheels

## Scotch-Brite™ Metal Finishing Wheels

- For decorative finishing and blending of all metals
- Creates a consistent satin finish
- Good conformability
- Produces a coarser and duller finish than Light Deburring Wheels
- Removes minor imperfections and handling marks



UPC	Size	Grade	Max RPM	Qty/Case
048011-05394-3†	6" x 1/2" x 1"	6A CRS	6,000	4
048011-05391-2†	6" x 1/2" x 1"	5A MED	6,000	4
048011-01861-4	6" x 1" x 1"	4A CRS	6,000	3
048011-01863-8	6" x 1" x 1"	5A CRS	6,000	3
048011-01866-9	6" x 1" x 1"	6A CRS	6,000	3
048011-01860-7†	6" x 1" x 1"	4A MED	6,000	3
048011-01862-1	6" x 1" x 1"	5A MED	6,000	3
048011-01865-2	6" x 1" x 1"	6A MED	6,000	3
048011-30012-2†	6" x 1" x 1-1/4"	5A CRS	6,000	3
048011-24110-4†	6" x 1" x 1-1/4"	5A MED	6,000	3
048011-01868-3	6" x 2" x 1"	4A CRS	6,000	2
048011-01888-1	6" x 2" x 1"	5A CRS	6,000	2
048011-01870-6†	6" x 2" x 1"	6A CRS	6,000	2
048011-01867-6	6" x 2" x 1"	4A MED	6,000	2
048011-01869-0	6" x 2" x 1"	5A MED	6,000	2
048011-01889-8†	6" x 2" x 1"	6A MED	6,000	2
048011-01891-1†	6" x 3" x 1"	4A CRS	6,000	1
048011-08891-4†	6" x 4" x 1"	4A MED	6,000	1
048011-16449-6†	8" x 1/2" x 3"	5A MED	4,500	4
048011-05414-8†	8" x 1" x 3"	4A CRS	4,500	3
048011-01872-0	8" x 1" x 3"	5A CRS	4,500	3
048011-01901-7†	8" x 1" x 3"	6A CRS	4,500	3
048011-08926-3†	8" x 1" x 3"	4A MED	4,500	3
048011-01871-3	8" x 1" x 3"	5A MED	4,500	3
048011-01900-0†	8" x 1" x 3"	6A MED	4,500	3
048011-01875-1†	8" x 2" x 3"	4A CRS	4,500	2
048011-01904-8	8" x 2" x 3"	5A CRS	4,500	2
048011-13453-6†	8" x 2" x 3"	6A CRS	4,500	2
048011-01874-4	8" x 2" x 3"	4A MED	4,500	2
048011-01876-8	8" x 2" x 3"	5A MED	4,500	2
048011-01905-5†	8" x 2" x 3"	6A MED	4,500	2
048011-15608-8†	8" x 3" x 3"	5A CRS	4,500	1
048011-05395-0†	8" x 3" x 3"	5A MED	4,500	1
048011-25612-2†	8" x 3" x 3"	6A MED	4,500	1
048011-15607-1†	12" x 1/2" x 5"	5A MED	3,000	2
048011-05398-1†	12" x 1" x 5"	5A CRS	3,000	1
048011-15062-8†	12" x 1" x 5"	6A CRS	3,000	1
048011-01916-1	12" x 1" x 5"	5A MED	3,000	1
048011-08924-9†	12" x 1" x 5"	6A MED	3,000	1
048011-15326-1†	12" x 1-1/2" x 5"	5A MED	3,000	1

†Made-to-Order

## Scotch-Brite™ Metal Finishing Wheels (cont)

UPC	Size	Grade	Max RPM	Qty/Case
048011-09612-4†	12" x 2" x 5"	4A CRS	3,000	1
048011-13449-9	12" x 2" x 5"	5A CRS	3,000	1
048011-13448-2†	12" x 2" x 5"	6A CRS	3,000	1
048011-01921-5†	12" x 2" x 5"	4A MED	3,000	1
048011-01882-9	12" x 2" x 5"	5A MED	3,000	1
048011-14617-1†	12" x 2" x 5"	6A MED	3,000	1
048011-08902-7†	12" x 3" x 5"	5A CRS	3,000	1
048011-92916-3†	12" x 3" x 5"	4A MED	3,000	1
048011-08929-4†	12" x 3" x 5"	5A MED	3,000	1
048011-13071-2†	12" x 4" x 5"	5A CRS	3,000	1
048011-05392-9†	12" x 4" x 5"	5A MED	3,000	1

†Made-to-Order

## Scotch-Brite™ Multi-Finishing Wheels

- For decorative, satin finishing and blending of all metals
- Often used on inline sanding tools for large surface repair
- Produces a bright finish with a wide scratch pattern
- Optimum conformability



UPC	Dia x W x AH	Grade	Max RPM	Qty/Case
048011-13170-2	6" x 1" x 1"	2S CRS	6,000	3
048011-13171-9	6" x 1" x 1"	2S MED	6,000	3
048011-13172-6	6" x 1" x 1"	2S FIN	6,000	3
048011-13176-4	6" x 2" x 1"	2S CRS	6,000	2
048011-13177-1	6" x 2" x 1"	2S MED	6,000	2
048011-13178-8	6" x 2" x 1"	2S FIN	6,000	2
048011-13183-2	8" x 1" x 3"	2S MED	4,500	3
048011-13184-9	8" x 1" x 3"	2S FIN	4,500	3
048011-13185-6	8" x 2" x 3"	2S CRS	4,500	2
048011-13186-3	8" x 2" x 3"	2S MED	4,500	2

**Attention:** Wheels are available in other grades and sizes. If you need a specific wheel not listed, contact your 3M Sales Specialist or 3M Authorized Distributor.

## Scotch-Brite™ Convolute Wheels

### Scotch-Brite™ Cut and Polish Wheels

- For aggressive finishing and blending applications
- Good for defect removal or heavy scratch blending
- Produces a dull finish with a tight scratch pattern
- Harder than other finishing wheels



UPC	Dia x W x AH	Grade	Max RPM	Qty/Case
048011-05253-3†	6" x 1/2" x 1"	7A CRS	6,000	4
048011-08931-7†	6" x 1/2" x 1"	7A MED	6,000	4
048011-05182-6	6" x 1/2" x 1"	5A FIN	6,000	4
048011-08946-1†	6" x 1/2" x 1"	7A FIN	6,000	4
048011-03263-4†	6" x 1" x 1"	7A CRS	6,000	3
048011-03262-7†	6" x 1" x 1"	7A MED	6,000	3
048011-02960-3	6" x 1" x 1"	5A FIN	6,000	3
048011-03270-2	6" x 1" x 1"	7A FIN	6,000	3
048011-03269-6†	6" x 1" x 1"	7A VFN	6,000	3
048011-03273-3†	6" x 2" x 1"	7A CRS	6,000	2
048011-03272-6†	6" x 2" x 1"	7A MED	6,000	2
048011-02972-6†	6" x 2" x 1"	5A FIN	6,000	2
048011-60043-7†	6" x 25" x 1"	7A MED	6,000	1
048011-05183-3†	8" x 1/2" x 3"	7A MED	4,500	4
048011-02974-0†	8" x 1" x 1-1/4"	5A FIN	4,500	3
048011-03277-1†	8" x 1" x 3"	7A CRS	4,500	3
048011-03276-4	8" x 1" x 3"	7A MED	4,500	3
048011-02965-8†	8" x 1" x 3"	5A FIN	4,500	3
048011-03275-7†	8" x 1" x 3"	7A FIN	4,500	3
048011-03274-0†	8" x 1" x 3"	7A VFN	4,500	3
048011-92862-3†	8" x 1-1/2" x 1-1/4"	5A FIN	4,500	2
048011-04156-8†	8" x 1-1/2" x 3"	5A FIN	4,500	2
048011-02976-4†	8" x 2" x 1-1/4"	5A FIN	4,500	2
048011-03282-5†	8" x 2" x 3"	7A CRS	4,500	2
048011-03281-8	8" x 2" x 3"	7A MED	4,500	2
048011-02967-2†	8" x 2" x 3"	5A FIN	4,500	2
048011-03280-1†	8" x 2" x 3"	7A FIN	4,500	2
048011-03279-5†	8" x 2" x 3"	7A VFN	4,500	2
048011-93674-1†	8" x 2-1/2" x 3"	7A MED	4,500	1
048011-93454-9†	8" x 4" x 3"	7A CRS	4,500	1
048011-05248-9†	8" x 7" x 3"	7A FIN	4,500	1
048011-15591-3†	8" x 24" x 3"	5A FIN	4,500	1
048011-13486-4†	8" x 25" x 3"	7A CRS	4,500	1
048011-92938-5†	8" x 25" x 3"	7A MED	4,500	1
048011-16463-2†	8" x 25" x 3"	5A FIN	4,500	1

†Made-to-Order

### Scotch-Brite™ Cut and Polish Wheels (cont)

UPC	Dia x W x AH	Grade	Max RPM	Qty/Case
048011-04244-2†	12" x 1/2" x 5"	7A MED	3,000	2
048011-05256-4†	12" x 1/2" x 5"	5A FIN	3,000	2
048011-03295-5†	12" x 1" x 5"	7A CRS	3,000	1
048011-03294-8†	12" x 1" x 5"	7A MED	3,000	1
048011-02975-7†	12" x 1" x 5"	5A FIN	3,000	1
048011-02977-1†	12" x 1-1/2" x 5"	5A FIN	3,000	1
048011-03300-6†	12" x 2" x 5"	7A CRS	3,000	1
048011-03299-3	12" x 2" x 5"	7A MED	3,000	1
048011-02969-6	12" x 2" x 5"	5A FIN	3,000	1
048011-03297-9†	12" x 2" x 5"	7A VFN	3,000	1
048011-03303-7†	12" x 3" x 5"	7A MED	3,000	1
048011-05908-2†	12" x 3" x 5"	5A FIN	3,000	1

†Made-to-Order

### Scotch-Brite™ Light Deburring Wheel

- For finishing applications; can also be used for light deburring
- Produces a bright and consistent finish with tight scratch pattern
- Very soft and conformable



UPC	Dia x W x AH	Grade	Max RPM	Qty/Case
048011-03993-0	6" x 1/2" x 1"	6S FIN	6,000	4
048011-01662-7	6" x 1/2" x 1"	7S FIN	6,000	4
048011-03994-7	6" x 1/2" x 1"	8S FIN	6,000	4
048011-01660-3	6" x 1" x 1"	6S FIN	6,000	3
048011-01661-0	6" x 1" x 1"	7S FIN	6,000	3
048011-01675-7	6" x 1" x 1"	8S FIN	6,000	3
048011-01664-1	6" x 2" x 1"	7S FIN	6,000	2
048011-05263-2	8" x 1/2" x 3"	7S FIN	4,500	4
048011-01678-8	8" x 1/2" x 3"	8S FIN	4,500	4
048011-01665-8	8" x 1" x 3"	6S FIN	4,500	3
048011-01666-5	8" x 1" x 3"	7S FIN	4,500	3
048011-01679-5	8" x 1" x 3"	8S FIN	4,500	3
048011-01667-2	8" x 2" x 3"	7S FIN	4,500	2
048011-01683-2	10" x 1" x 5"	7S FIN	3,600	2
048011-05181-9	12" x 1/2" x 5"	7S FIN	3,000	2
048011-01669-6	12" x 1" x 5"	6S FIN	3,000	1
048011-01670-2	12" x 1" x 5"	7S FIN	3,000	1
048011-01686-3	12" x 1" x 5"	8S FIN	3,000	1
048011-01672-6	12" x 2" x 5"	6S FIN	3,000	1
048011-01673-3	12" x 2" x 5"	7S FIN	3,000	1
048011-01689-4	12" x 2" x 5"	8S FIN	3,000	1
048011-01690-0	12" x 3" x 5"	7S FIN	3,000	1
048011-17985-8	16" x 2" x 10"	7S FIN	2,250	1

**Attention:** Wheels are available in other grades and sizes. If you need a specific wheel not listed, contact your 3M Sales Specialist or 3M Authorized Distributor.

# Scotch-Brite™ Unitized Wheels

Get high performance and durability in a variety of cleaning, deburring, finishing and polishing applications. Used on die grinders and angle grinders, Scotch-Brite™ Wheels produce great results on all types of metal, composites and glass.

## Unitized Wheels Selection Guide

Scotch-Brite™ Unitized Wheel performance differences can be attributed to mineral (aggressiveness) and density (hardness). The combination of these two characteristics and subtle variations determine if the wheel will cut more aggressively or will be more durable and less conformable.

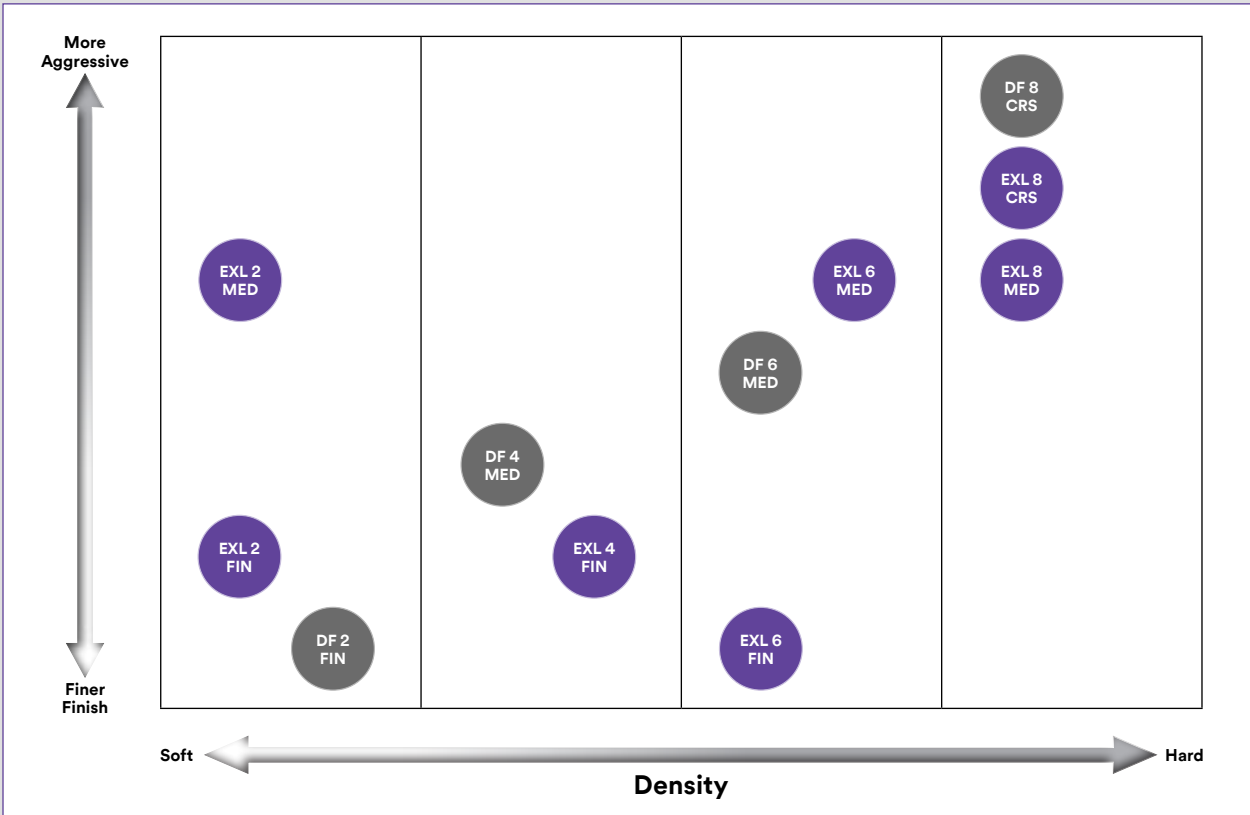

**Mineral Abbreviations (prefix to grade)**  
 A: Aluminum Oxide mineral    S: Silicon Carbide mineral  
 C: Ceramic

Scotch-Brite™ Unitized Wheel	Application			
	Deburring	Blending	Finishing	Polishing
EXL Deburring (EXL)	•	•	•	•
Deburr & Finish Pro (DF)	•	•	•	

**Attention:** Wheels are available in other grades and sizes. If you need a specific wheel not listed, contact your 3M Sales Specialist or 3M Authorized Distributor.

## Scotch-Brite™ Unitized Wheels

### Scotch-Brite™ Roloc™ TR Debur & Finish PRO Unitized Wheel

- Ideal for both OE use and for maintenance operations
- Soft to reduce defects, yet wear like iron, for fewer wheel changeouts
- Faster burr removal
- Better finish



UPC	Size (Dia x Thk x Ctr Hole)	Max. RPM	Den	Grade	Qty/ Case
048011-65081-4+	2" x 1/8" x NH	22,100	6C	MED+	60
076308-77231-4	2" x 1/4" x NH	22,100	2S	FIN	60
076308-77115-7	2" x 1/4" x NH	22,100	4C	MED+	60
076308-77198-0	2" x 1/4" x NH	18,100	8C	CRS+	60
048011-65082-1	2" x 1/4" x NH	22,100	6C	MED+	60
048011-65084-5	3" x 1/8" x NH	15,100	6C	MED+	40
076308-77197-3	3" x 1/8" x NH	15,100	8C	CRS+	40
076308-77233-8	3" x 1/4" x NH	15,100	2S	FIN	40
076308-77116-4	3" x 1/4" x NH	15,100	4C	MED+	40
048011-65083-8	3" x 1/4" x NH	15,100	6C	MED+	40
076308-77199-7	3" x 1/4" x NH	15,100	8C	CRS+	40

\*Made-to-Order

### Scotch-Brite™ Debur & Finish PRO Unitized Wheel

- Unitized production enhances abrasive durability and strength, helping prolong service life
- 3M precision-shaped grain is engineered to cut fast and sharp, enabling quicker burr removal
- Non-woven construction permits dust and debris to escape, minimizing loading
- Perfect for moderate to heavy deburring



UPC	Dia x W x Hole	Max RPM	Den	Grade	Qty/ Case
638060-05164-1	1" x 1" x 3/16"	30,100	2S	FIN	50
048011-65017-3	1" x 1" x 3/16"	35,100	6C	MED+	50
048011-65057-9+	2" x 1/8" x 1/4"	22,100	6C	MED+	60
638060-05165-8	2" x 1/4" x 1/4"	16,100	2S	FIN	60
048011-65018-0	2" x 1/4" x 1/4"	22,100	6C	MED+	60
638060-05166-5	2" x 1/2" x 1/4"	16,100	2S	FIN	30
048011-65019-7	2" x 1/2" x 1/4"	22,100	6C	MED+	30
638060-05167-2	2" x 3/4" x 1/4"	16,100	2S	FIN	20
048011-65020-3	2" x 3/4" x 1/4"	22,100	6C	MED+	20
048011-65058-6+	2" x 1" x 1/4"	22,100	6C	MED+	10

\*Made-to-Order

### Scotch-Brite™ Debur & Finish PRO Unitized Wheel (cont)

	Dia x W x Hole	Den	Grade	Max RPM	Qty/ Case
048011-65021-0	3" x 1/8" x 1/4"	6C	MED+	18,100	40
638060-05161-0	3" x 1/4" x 1/4"	2S	FIN	12,100	40
076308-77111-9+	3" x 1/4" x 1/4"	4C	MED+	18,100	40
048011-65004-3	3" x 1/4" x 1/4"	6C	MED+	18,100	40
638060-05163-4	3" x 1/2" x 1/4"	2S	FIN	10,000	20
076308-77110-2	3" x 1/2" x 1/4"	4C	MED+	18,100	20
048011-65007-4	3" x 1/2" x 1/4"	6C	MED+	18,100	20
638060-05171-9	3" x 1/2" x 3/8"	2S	FIN	10,000	20
638060-05168-9	3" x 3/4" x 1/4"	2S	FIN	10,000	20
048011-65022-7	3" x 3/4" x 1/4"	6C	MED+	15,100	20
638060-05162-7	3" x 1" x 1/4"	2S	FIN	10,000	10
048011-65005-0	3" x 1" x 1/4"	6C	MED+	15,100	10
076308-77103-4+	4" x 1" x 1/4"	6C	MED+	12,100	5
638060-05170-2	6" x 1/2" x 1"	2S	FIN	5,000	4
638060-05169-6	6" x 1" x 1"	2S	FIN	5,000	2

#### Typical use: on backstand or bench motor

076308-90123-3	1" x 1" x 3/16"	8C	CRS+	35,100	50
076308-90129-5	2" x 1/8" x 1/4"	8C	CRS+	22,100	60
076308-90124-0	2" x 1/4" x 1/4"	8C	CRS+	22,100	60
076308-90125-7	2" x 1/2" x 1/4"	8C	CRS+	22,100	30
076308-90126-4	2" x 3/4" x 1/4"	8C	CRS+	22,100	20
076308-90127-1	3" x 1/8" x 1/4"	8C	CRS+	18,100	40
076308-90120-2	3" x 1/4" x 1/4"	8C	CRS+	18,100	10
076308-90122-6	3" x 1/2" x 1/4"	8C	CRS+	15,100	20
076308-90132-5	3" x 1/2" x 3/8"	8C	CRS+	15,100	20
076308-90128-8+	3" x 3/4" x 1/4"	8C	CRS+	15,100	20
076308-90121-9+	3" x 1" x 1/4"	8C	CRS+	15,100	10
048011-65078-4+	5" x 1/4" x 1/4"	6C	MED+	9,000	10
048011-65079-1+	5" x 1/2" x 1/4"	6C	MED+	9,000	5
076308-77109-6+	6" x 1/8" x 1"	6C	MED+	7,500	16
076308-77108-9+	6" x 1/4" x 1"	6C	MED+	7,500	8
048011-65074-6	6" x 1/2" x 1/2"	6C	MED+	7,500	4
048011-65076-0+	6" x 1/2" x 1"	6C	MED+	7,500	4
076308-90131-8	6" x 1/2" x 1"	8C	CRS+	7,500	4
048011-65097-5+	6" x 1" x 1/2"	6C	MED+	7,500	2
048011-65075-3	6" x 1" x 1"	6C	MED+	7,500	2
076308-90130-1+	6" x 1" x 1"	8C	CRS+	7,500	2

#### Made-to-Order Sizes

076308-77196-6	Generic	8C	CRS+	Varies	Depends on wheel size
----------------	---------	----	------	--------	-----------------------

\*Made-to-Order

**Attention:** Wheels are available in other grades and sizes. If you need a specific wheel not listed, contact your 3M Sales Specialist or 3M Authorized Distributor.

# Scotch-Brite™ Unitized Wheels

## Scotch-Brite™ EXL Unitized Deburring Wheels

- Strong and efficient for deburring and polishing of all metal alloys
- Excellent in resisting smearing and minimizing heat buildup on the work piece
- Conformable wheel in a variety of densities and grades for maximum cut and durability



UPC	Dia x W x AH	Grade	Max RPM	Qty/Case
048011-15516-6	1" x 1/8" x 1/8"	8A CRS	35,100	100
048011-15517-3	1" x 1/8" x 1/8"	6A MED	35,100	100
048011-13734-6	1" x 1/4" x 1/8"	2S FIN	35,100	100
048011-13752-0	1" x 1" x 3/16"	8A CRS	35,100	50
048011-15527-2	1" x 1" x 3/16"	2A MED	35,100	50
048011-14063-6	1" x 1" x 3/16"	6A MED	35,100	100
048011-13753-7	1" x 1" x 3/16"	8A MED	35,100	50
048011-13713-1	1" x 1" x 3/16"	2S FIN	35,100	50
048011-15514-2	1-1/2" x 1/8" x 3/16"	8A CRS	30,100	80
048011-15515-9	1-1/2" x 1/8" x 3/16"	6A MED	30,100	80
048011-13714-8	1-1/2" x 1/4" x 1/8"	2S FIN	30,100	80
048011-14746-8	1-1/2" x 1/4" x 3/16"	2S FIN	30,100	80
048011-15511-1	2" x 1/8" x 3/16"	8A CRS	22,100	60
048011-15512-8	2" x 1/8" x 3/16"	6A MED	22,100	60
048011-13736-0	2" x 1/4" x 1/8"	2S FIN	16,100	60
048011-15513-5	2" x 1/4" x 3/16"	2S FIN	16,100	60
048011-13755-1	2" x 1/4" x 1/4"	8A CRS	22,100	60
048011-15529-6	2" x 1/4" x 1/4"	2A MED	16,100	60
048011-13932-6	2" x 1/4" x 1/4"	2S FIN	16,100	60
048011-13715-5	2" x 1/2" x 1/4"	2S FIN	16,100	30
048011-15462-6	3" x 1/8" x 1/4"	8A MED	18,100	40
048011-13763-6	3" x 1/4" x 1/4"	8A CRS	18,100	40
048011-15531-9	3" x 1/4" x 1/4"	2A MED	12,100	40
048011-14067-4	3" x 1/4" x 1/4"	6A MED	18,100	40
048011-13764-3	3" x 1/4" x 1/4"	8A MED	18,100	40
048011-13716-2	3" x 1/4" x 1/4"	2S FIN	12,100	40
048011-13766-7	3" x 1/4" x 3/8"	8A CRS	18,100	40
048011-16054-2	3" x 1/4" x 3/8"	2A MED	12,100	40
048011-15118-2	3" x 1/4" x 3/8"	6A MED	18,100	40
048011-14753-6	3" x 1/4" x 3/8"	8A MED	18,100	40
048011-14750-5	3" x 1/4" x 3/8"	2S FIN	12,100	40
048011-14751-2	3" x 1/4" x 3/8"	4A FIN	18,100	40
048011-14752-9	3" x 1/4" x 3/8"	6S FIN	18,100	40
048011-13767-4	3" x 1/2" x 1/4"	8A CRS	15,100	20
048011-15532-6	3" x 1/2" x 1/4"	2A MED	10,000	20
048011-13717-9	3" x 1/2" x 1/4"	2S FIN	10,000	20
048011-13718-6	3" x 3/4" x 1/4"	2S FIN	10,000	10
048011-13739-1	4" x 1/4" x 1/4"	2S FIN	8,500	20

## Scotch-Brite™ EXL Unitized Deburring Wheels (cont)

UPC	Dia x W x AH	Grade	Max RPM	Qty/Case
048011-17498-3	6" x 1/4" x 1/2"	2A MED	4,500	8
048011-13741-4	6" x 1/4" x 1/2"	2S FIN	5,000	8
048011-25678-8	6" x 1/4" x 3/4"	2S FIN	5,000	8
048011-15534-0	6" x 1/2" x 1/2"	2A MED	4,500	4
048011-13719-3	6" x 1/2" x 1/2"	2S FIN	5,000	4
048011-15831-0	6" x 1/2" x 5/8"	2S FIN	5,000	4
048011-16545-5	6" x 1/2" x 1"	2A MED	4,500	4
048011-14379-8	6" x 1/2" x 1"	2S FIN	5,000	4
048011-13742-1	6" x 1" x 1/2"	2S FIN	5,000	2
048011-16544-8	6" x 1" x 1"	2A MED	4,500	2
048011-13743-8	6" x 1" x 1"	2S FIN	5,000	2
048011-15827-3	8" x 1/4" x 1/2"	2S FIN	4,000	8
048011-15844-0	8" x 1/2" x 1/2"	2S FIN	4,000	4
048011-15824-2	8" x 1/2" x 3/4"	2S FIN	4,000	4
048011-15817-4	12" x 1/2" x 1-1/4"	2S FIN	2,600	2

## Scotch-Brite™ Cut and Polish Unitized Wheel

- Tightly layered "unitized" construction offers long life and durability
- Excellent for aggressive heavy duty blending and finishing with uniform results
- Good replacement for rubber bonded wheels and small set-up wheels



UPC	Dia x W x AH	Grade	Max RPM	Qty/Case
048011-03701-1	1" x 1" x 3/16"	7A CRS	35,100	50
048011-03700-4	1" x 1" x 3/16"	7A MED	35,100	50
048011-01560-6	1" x 1" x 3/16"	5A FIN	35,100	50
048011-08939-3	2" x 1/8" x 1/8"	7A MED	22,100	60
048011-03714-1	2" x 1/8" x 1/4"	7A MED	22,100	60
048011-03716-5	2" x 1/4" x 1/4"	7A CRS	22,100	60
048011-03715-8	2" x 1/4" x 1/4"	7A MED	22,100	60
048011-01561-3	2" x 1/4" x 1/4"	5A FIN	22,100	60
048011-03718-9	2" x 1/2" x 1/4"	7A MED	20,100	30
048011-03727-1	3" x 1/8" x 1/4"	7A MED	18,100	40
048011-03729-5	3" x 1/4" x 1/4"	7A CRS	18,100	40
048011-03728-8	3" x 1/4" x 1/4"	7A MED	18,100	40
048011-01563-7	3" x 1/4" x 1/4"	5A FIN	18,100	40
048011-15121-2	3" x 1/4" x 3/8"	5A FIN	18,100	40
048011-03705-9	3" x 1/2" x 1/4"	7A MED	15,100	20
048011-01565-1	3" x 1/2" x 1/4"	5A FIN	15,100	20
048011-03732-5	3" x 1/2" x 3/8"	7A MED	15,100	20
048011-08878-5	3" x 1/2" x 3/8"	5A FIN	15,100	20
048011-03738-7	3" x 3/4" x 3/8"	7A MED	15,100	10
048011-03740-0	3" x 1" x 1/4"	7A MED	15,100	10
048011-01578-1	4" x 1/4" x 1/4"	5A FIN	12,100	20
048011-01581-1	6" x 1/4" x 1/2"	5A FIN	7,500	8

**Attention:** Wheels are available in other grades and sizes. If you need a specific wheel not listed, contact your 3M Sales Specialist or 3M Authorized Distributor.

# Abrasive Wheel Systems

## 3M™ Flap Wheels

Coated Abrasive flap wheels are the ideal choice for light grinding, blending, graining and scale removal on a variety of metals. The abrasive flaps offer a long lasting supply of fresh abrasives and a load resistant design. Available in both flange mounted and spindle mounted constructions with general purpose aluminum oxide or high performing 3M ceramic aluminum oxide blend abrasive grain.

### 3M™ Spindle Mounted Flap Wheel Selection Guide

Product	Mineral	Grade	Performance	Stainless Steel	Carbon Steel
747D	Ceramic Aluminum Oxide Blend	36-150	Advanced	■	■
244D	Aluminum Oxide	60-120	Good	■	■

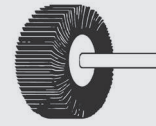

T83; 1/4" Straight



T84; 1/4-20 Threaded

### 3M™ Flap Wheels 741A

- 3M ceramic aluminum oxide blend abrasive grain on a durable X wt cloth backing
- Longer life and faster cut



UPC	Dia x W x AH	Grade	Max RPM	Qty/Case
<b>Flange Mounted</b>				
051144-82770-1	6" x 1" x 1"	50	6,100	5
051144-81986-7	6" x 1" x 1"	60	6,100	5
051144-81984-3	6" x 1" x 1"	80	6,100	5

### 3M™ Flap Wheels 741A can be Made-to-Order in these sizes:

Diameter	Arbor Hole
> 3" – 4-1/2"	5/8"
> 4-1/2" – 6"	1"
> 6" – 8"	1" or 1-1/4"
> 8" – 10"	1-3/4" or 2"

### 3M™ Flap Wheels 244D T83 and T84

- Aluminum oxide
- General purpose flap wheel delivers consistent finish and uniform cut



UPC	Dia x W x Shk	Grade	Max RPM	Qty/Case
<b>T83; 1/4" Straight</b>				
051144-35475-7	1" x 1" x 1/4"	60	30,000	10
051144-35476-4	1" x 1" x 1/4"	80	30,000	10
051144-35477-1	1" x 1" x 1/4"	120	30,000	10
051144-14623-9	2" x 1" x 1/4"	60	25,000	10
051144-14624-6	2" x 1" x 1/4"	80	25,000	10
051144-14625-3	2" x 1" x 1/4"	120	25,000	10
051144-14655-0	3" x 1" x 1/4"	60	20,000	10
051144-14656-7	3" x 1" x 1/4"	80	20,000	10
051144-14657-4	3" x 1" x 1/4"	120	20,000	10
<b>T84; 1/4-20 Threaded</b>				
051144-35467-2	1" x 1" x 1/4-20 EXT	60	30,000	10
051144-35468-9	1" x 1" x 1/4-20 EXT	80	30,000	10
051144-35469-6	1" x 1" x 1/4-20 EXT	120	30,000	10
051144-14575-1	2" x 1" x 1/4-20 EXT	60	25,000	10
051144-14576-8	2" x 1" x 1/4-20 EXT	80	25,000	10
051144-14607-9	3" x 1" x 1/4-20 EXT	60	20,000	10
051144-14608-6	3" x 1" x 1/4-20 EXT	80	20,000	10

### 3M™ Flap Wheels 747D T83 and T84

- 3M ceramic aluminum oxide blend abrasive grain on a resin-bonded X wt cloth backing
- Includes a grinding aid for cooler running on stainless steel



UPC	Dia x W x Shk	Grade	Max RPM	Qty/Case
<b>T83; 1/4" Straight</b>				
051144-80761-1	1" x 1" x 1/4"	60	30,000	10
051144-80757-4	1" x 1" x 1/4"	80	30,000	10
051144-80753-6	1" x 1" x 1/4"	P120	30,000	10
051144-80763-5	2" x 1" x 1/4"	60	25,000	10
051144-80759-8	2" x 1" x 1/4"	80	25,000	10
051144-80755-0	2" x 1" x 1/4"	P120	25,000	10
051144-80650-8	3" x 1" x 1/4"	60	20,000	10
051144-80651-5	3" x 1" x 1/4"	80	20,000	10
051144-80652-2	3" x 1" x 1/4"	P120	20,000	10
<b>T84; 1/4-20 Threaded</b>				
051144-83271-2	2" x 1" x 1/4-20 EXT	60	25,000	10
051144-83268-2	2" x 1" x 1/4-20 EXT	80	25,000	10
051144-83269-9	3" x 1" x 1/4-20 EXT	60	20,000	10
051144-83267-5	3" x 1" x 1/4-20 EXT	80	20,000	10

**Attention:** Wheels are available in other grades and sizes. If you need a specific wheel not listed, contact your 3M Sales Specialist or 3M Authorized Distributor.

# 3M™ Power Tools: Abrasive Wheel Systems

## 3M™ Die Grinders: 0.3 HP (224W)

- Ideal for light-duty applications such as deburring, blending, finishing and polishing in intricate and hard-to-reach areas
- Exclusive 3M™ Gripping Material reduces vibration and provides a more secure grip



UPC	Model	Max RPM	Noise Level dBA (power)	Weight Pound (kg)	Length Inch (mm)	Height Inch (mm)	Air Inlet Thread	Air Flow Rate SCFM (LPM)	Collet Size
051141-28630-3	28630	25,000	86 (98)	1.4 (0.6)	10 (248)	1 (35)	1/4" NPT	17 (481)	1/4"*
051141-28629-7	28629	25,000	78 (90)	0.9 (0.4)	6 (152)	1 (35)	1/4" NPT	17 (481)	1/4"*
051141-28628-0	28628	18,000	80 (92)	1.5 (0.7)	11 (267)	1 (35)	1/4" NPT	17 (481)	1/4"*
051141-28627-3	28627	18,000	79 (91)	1.2 (0.5)	7 (184)	1 (35)	1/4" NPT	17 (481)	1/4"*

\*Includes 1/8" collet insert (PN55772)

## 3M™ Die Grinders: 0.5 HP (372W)

- Ideal for medium-duty applications such as polishing, buffing, shaping and deburring
- Exclusive 3M™ Gripping Material reduces vibration and provides a more secure grip



UPC	Model	Max RPM	Noise Level dBA (power)	Weight Pound (kg)	Length Inch (mm)	Height Inch (mm)	Air Inlet Thread	Air Flow Rate SCFM (LPM)	Collet Size
051141-28330-2	28330	18,000	87 (99)	1.1 (0.5)	7 (175)	3 (70)	1/4" NPT	26 (736)	1/4"
051141-28331-9	28331	18,000*	87 (99)	1.5 (0.7)	11 (270)	3 (70)	1/4" NPT	26 (736)	1/4"
051141-28332-6	28332	4,000	87 (99)	1.6 (0.7)	9 (200)	3 (70)	1/4" NPT	26 (736)	1/4"

\*With extension

## 3M™ Die Grinders: 1 HP (744W)

- Excellent for big jobs such as weld or stock removal
- Exclusive 3M™ Gripping Material reduces vibration and provides a more secure grip











UPC	Model	Max RPM	Noise Level dBA (power)	Weight Pound (kg)	Length Inch (mm)	Height Inch (mm)	Air Inlet Thread	Air Flow Rate SCFM (LPM)	Collet Size
051141-20237-2	20237	20,000	86 (98)	2.0 (0.9)	8 (197)	3 (73)	3/8" NPT	37 (1,048)	1/4"*
051141-20238-9	20238	18,000	89 (101)	2.0 (0.9)	8 (197)	3 (73)	3/8" NPT	37 (1,048)	1/4"*
051141-28770-6	28770	18,000	84 (95)	3.0 (1.4)	13 (318)	3 (73)	3/8" NPT	37 (1,048)	1/4"*
051141-20239-6	20239	12,000	N/A	2.6 (1.2)	10 (254)	3 (81)	3/8" NPT	37 (1,048)	1/4"*
051141-20240-2	20240	8,000	N/A	2.6 (1.2)	10 (254)	3 (81)	3/8" NPT	37 (1,048)	1/4"*

\*Available in metric collet





### Collet Insert Availability for 3M™ Die Grinders

Tool Model	HP	RPM	Length	Collet Insert Size and Part Number									
				1/8" (06573)	1/8" (55772)	3/16" (06574)	1/4" (06575)	1/4" (55752)	3/8" (06545)	3 mm (06576)	6 mm (06577)	8 mm (06546)	
28630	0.3	25,000	Extended		●				●				
28629	0.3	25,000	Regular		●				●				
28628	0.3	18,000	Extended		●				●				
28627	0.3	18,000	Regular		●				●				
28330	0.5	18,000	Regular	●		●	●		●	●	●	●	●
28331	0.5	18,000	Extended		●				●				
28332	0.5	4,000	Regular	●		●	●		●	●	●	●	●
20237	1	20,000	Regular	●		●	●		●	●	●	●	●
20238	1	18,000	Regular	●		●	●		●	●	●	●	●
28770	1	18,000	Extended	●		●	●		●	●	●	●	●
20239	1	12,000	Regular	●		●	●		●	●	●	●	●
20240	1	8,000	Regular	●		●	●		●	●	●	●	●

## Accessories: Abrasive Wheel Systems

Product	UPC	For Use With	Size/Description	Max RPM	Qty/Case
<b>Mandrel 990</b> 	048011-15012-3	Scotch-Brite™ Unitized Wheels with 3/16" Center Hole	1-3/4" x 1/4" x 1"	25,100	5
<b>Mandrel 936</b> 	048011-04018-9	Scotch-Brite™ Unitized Wheels with 3/8" Center Hole	2-1/16" x 1/4" x 3/4"	22,200	5
<b>Unitized Wheel Mandrels</b> <b>28848</b> 	051141-28848-2	2" or 3" OD, 1/4" thick unitized wheels with 1/4" diameter center hole	1-5/8" x 1/4" x 3/4" x 1/4"	18100 (3") 22100 (2")	5
<b>28850</b> 	051141-28847-5	2" or 3" OD, 1/8" thick unitized wheels with 1/4" diameter center hole	1-1/2" x 1/4" x 3/4" x 1/8"	18100 (3") 22100 (2")	5
<b>28838</b> 	051141-28849-9	2" or 3" OD, 1/2" thick unitized wheels with 1/4" diameter center hole	1-7/8" x 1/4" x 3/4" x 1/2"	18100 (3") 22100 (2")	5
	051141-28850-5	2" or 3" OD, 3/4" thick unitized wheels with 1/4" diameter center hole	2-1/8" x 1/4" x 3/4" x 3/4"	16100 (3") 18100 (2")	5
	051141-28851-2	2" or 3" OD, 1" thick unitized wheels with 1/4" diameter center hole	2-3/8" x 1/4" x 3/4" x 1"	16100 (3") 18100 (2")	5
	051141-28838-3	3" OD, 1/8" to 1/2" thick, 1/4" diameter center hole deburr & finish unitized wheels	2-1/2" x 1/4 in x 1"	18100	5
<b>Flange Adapter Kit No. 5</b> 	048011-16859-3	6" Wheels; Telescoping wheel adapters 1" and 1/2" wide to reduce 1" wheel cores to fit 1/2", 5/8", 3/4", or 7/8" shafts; Must be used with side flanges	1" x 1/2" x 1/2"	N/A	1 Set
	048011-16860-9		1" x 1" x 1/2"	N/A	1 set/bag 5 sets/case
<b>Flange Nut</b> 	051141-28739-3	4" x 1/4" x 5/8" CH Unitized Wheels and Depressed Center Grinding Wheels	1" x 5/8" x 3/8"; 3/8-24 INT	N/A	1 set/bag 5 sets/case
	051141-28740-9		1" x /8"; 5/8-11 INT	N/A	1 set/bag 5 sets/case
<b>Wheel Adapter Kit No.3</b> 	051144-45035-0	Two arbor hole (plug type) adapters for 6" and 8" diameter flap wheels	1" OD x 1/2" ID	N/A	1
	051144-45034-3		1" OD x 5/8" ID	N/A	1
	051144-45033-6		1" OD x 3/4" ID	N/A	1
	051144-45032-9		1" OD x 7/8" ID	N/A	1
<b>Wheel Adapter Kit No. 81A</b> 	051144-45081-7	For T84 Flap Wheels	1/4" x 1/4-20 INT	N/A	1

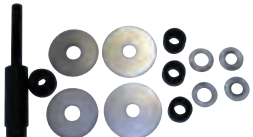
## Accessories: Abrasive Wheel Systems

Product	UPC	For Use With	Size/Description	Max RPM	Qty/Case
<b>Mandrel 933</b> 	048011-13968-5	Furnished complete with washers to fit available wheel sizes; Fits 1/4" x 5/16" center holes	1/4" Shaft Diameter; 2" x 1/4" x 1"	14,000	5
<b>Mandrel 934</b> 	048011-04021-9	Furnished complete with washers to fit available wheel sizes; Fits 1/2" center holes	1/2" Shaft Diameter; 3-1/16" x 1/4" x 2-1/2"	12,000	1
<b>3M™ Wheel Adapter Kit 28419</b> 	051141-28419-4	3M™ Inline Sanders; Wheels with 1/2"-1" center holes	1/2-20 EXT x 5/8-11 INT	See MOS of wheel	1
<b>3M™ Wheel Adapter Kit 45038</b> 	051144-45038-1	3M™ Inline Sanders; Wheels with 5/8"-1" center holes	5/8-11 EXT x 5/8-11 INT	See MOS of wheel	1
<b>3M™ Spindle Extender Kit</b> 	048011-04019-6	3M™ Inline Sanders; Wheels with 5/8"-1" center holes	Part 300	See MOS of wheel	1

### Contact Information

Large Diameter Wheel Flanges and Other Accessories are available and may be purchased directly through Contract Production Services/CPS. Please contact Contract Production Services/CPS directly to check availability and other specific information. Use the part number to identify and specify the desired item.

#### Contract Production Services/CPS

1936 Lyndale Avenue South  
 Minneapolis, MN 55403  
[cpsabrasives.com](http://cpsabrasives.com)





Toll Free: 800-843-0619  
 Tel: 612-767-2978  
 Fax: 612-872-0189

Office Hours:  
 Monday – Thursday  
 6:00 a.m. – 4:00 p.m. (Central Time)

# Inline Sanding Systems

## Level Welds Quickly to Match Directional Mill Finishes

In three easy steps, using the 3M Finishing System, you can grind and blend welds to match your finish.

		Product
<b>Step 1</b> Leveling the Weld		<b>Premium</b> 3M™ Cubitron™ II Fibre Disc 987C
		<b>Advanced</b> 3M™ Fibre Disc 787C
		<b>Advanced</b> 3M™ Fibre Disc 501C
<b>Step 2</b> Setting the Grain		<b>Premium</b> 3M™ Cubitron™ II Belt 947A
		<b>Advanced</b> 3M™ Belt 777F
<b>Step 3:</b> Final Finishing		<b>Premium</b> Scotch-Brite™ Surface Conditioning Belt A MED for a #4 finish, A CRS for a #3 finish
		<b>Premium</b> Scotch-Brite™ Match and Finish Flap Brush HS A CRS, A MED
<b>Final:</b> Blending and Touch-up Applications		<b>Premium</b> Scotch-Brite™ Hand Pad 7446 S MED

## 3M™ Belts and Scotch-Brite™ Belts and Brushes

### 3M™ Cubitron™ II Abrasive Belt 947A

- Made with revolutionary 3M precision shaped abrasive grain technology
- Flexible X wt poly-cotton backing
- Optimized for low-medium pressure applications on stainless, mild steel and aluminum



UPC	W x L	Grade	Min/Case
051125-94733-6	3-1/2" x 15-1/2"	60+	10/50
051125-94734-3	3-1/2" x 15-1/2"	80+	10/50
051125-94735-0	3-1/2" x 15-1/2"	120+	10/50

### 3M™ Cloth Belt 777F for Inline Sanders

- An abrasive belt for use with in-line drum sanders
- 3M™ Ceramic Aluminum Oxide blend abrasive grain for long lasting performance
- Grinding aid for cooler cutting action



UPC	Size	Grade	Qty/Case
051144-77476-0	3-1/2" x 15-1/2"	60	50
051144-77333-6	3-1/2" x 15-1/2"	80	50
051144-84307-7	3-1/2" x 15-1/2"	P120	50

### Scotch-Brite™ Surface Conditioning Belt for Inline Sanders

- Match and blend final finishes
- Run at low speeds to generate uniform, well-blended satin finishes
- 1 HP



UPC	Size	Grade	Color	Qty/Case
048011-09650-6	3" x 10-11/16"	A VFN	Blue	10
048011-05016-4	3-1/2" x 15-1/2"	A CRS	Brown	10
048011-05228-1	3-1/2" x 15-1/2"	A MED	Maroon	10
048011-05643-2	3-1/2" x 15-1/2"	A VFN	Blue	10

### Scotch-Brite™ Match and Finish Flap Brushes and Combi Flap Brushes

- Match final finishes back into fabricated metals like stainless steel, aluminum, brass and others
- Conforms to most surface geometrics
- Easy to control
- Easy-thread on/off attachment
- Max RPM: 3,500 RPM



UPC	D x W x CH	Grade	Color	Qty/Case
<b>Flap Brushes</b>				
051141-55748-9	4-1/2" x 4" x 5/8-11	5A XCS	Black	2
051141-55749-6	4-1/2" x 4" x 5/8-11	HS 7A CRS	Gold	2
051141-55750-2	4-1/2" x 4" x 5/8-11	HS 7A MED	Purple	2
051141-55745-8	4-1/2" x 4" x 5/8-11	5A MED	Maroon	2
051141-55747-2	4-1/2" x 4" x 5/8-11	5S MED	Gray	2
051141-55746-5	4-1/2" x 4" x 5/8-11	5A VFIN	Maroon	2
051141-55730-4	4-1/2" x 2" x 5/8-11*	5A XCS	Black	2
051141-55731-1	4-1/2" x 2" x 5/8-11*	HS 7A CRS	Gold	2
051141-55732-8	4-1/2" x 2" x 5/8-11*	HS 7A MED	Purple	2
051141-55727-4	4-1/2" x 2" x 5/8-11*	5A MED	Maroon	2
051141-55729-8	4-1/2" x 2" x 5/8-11*	5S MED	Gray	2
051141-55728-1	4-1/2" x 2" x 5/8-11*	5A VFIN	Maroon	2
<b>Combi Flap Brushes</b>				
051141-55744-1	4-1/2" x 4" x 5/8-11	A 60	Maroon	2
051141-55742-7	4-1/2" x 4" x 5/8-11	A 100	Maroon	2
051141-55743-4	4-1/2" x 4" x 5/8-11	A 150	Maroon	2
051141-55726-7	4-1/2" x 2" x 5/8-11*	A 60	Maroon	2
051141-55724-3	4-1/2" x 2" x 5/8-11*	A 100	Maroon	2
051141-55725-0	4-1/2" x 2" x 5/8-11*	A 150	Maroon	2

\*Also available in 4-way keyway attachments.

## 3M™ Power Tools: Inline Sanding Systems

### 3M™ Inline Sander: 1 HP (744W)

- Generate straight-line scratches for finishing stainless steel and other metals
- Can be used with inflatable or slotted wheel accessories and many other wheel products



UPC	Model	Shaft Size	Max RPM	Noise Level dBA (power)	Weight Pound (kg)	Length Inch (mm)	Air Inlet Thread	Airflow Rate SCFM (LPM)
051141-28339-5	28339	5/8"-11 EXT	3,500	90 (102)	3.3 (1.5)	9 (216)	3/8" NPT	37 (1,048)

### 3M™ Match and Finish Sander: 1 HP (744W)





- Generate straight-line scratches for finishing stainless steel and other metals
- Front to back motion helps prevent curved scratches
- Easy to control for reduced start/stop marks
- Easy screw-on/screw-off attachments
- Design for use with Scotch-Brite™ Match and Finish Flap Brushes, 3M™ Abrasive Belts or Scotch-Brite™ Belts\*



UPC	Model	Shaft Size	Max RPM	Noise Level dBA (power)	Weight Pound (kg)	Length Inch (mm)	Air Inlet Thread	Airflow Rate SCFM (LPM)
051141-28659-4	28659	5/8"-11 EXT	3,500	N/A	4.6 (2.1)	13.5 (343)	1/4" NPT	37 (1,048)

\*To run belt products, 3M™ Expander Wheel (28718) and Adapter Kit (28719) are required.

# Accessories: Inline Sanding Systems

Product	UPC	For Use With	Size/Description	Max RPM	Qty/Case
<b>For Inline Sander</b>					
<b>3M™ Rubber Slotted Expander Wheels</b> 	051141-28348-7	For use with belts 3-1/2" x 15-1/2" or 3" x 10-11/16"	5" x 3-1/2" 5/8" Arbor Hole	3,500	1
	051141-28349-4		3-1/4" x 3" 5/8" Arbor Hole	3,500	1
	051144-77722-8		3" x 3" x 5/8-11 IN	6,000	1
	051141-28718-8		5" x 3-1/2" x 1" AH	3,500	1
<b>3M™ Wheel Adapter Kit 45038</b> 	051144-45038-1	To mount wheels with 5/8"-1" center holes on 3M™ Inline Sanders	5/8-11 EXT x 5/8-11 INT	See MOS of wheel	1
<b>3M™ Spindle Extender Kit</b> 	048011-04019-6	To mount wheels with 5/8"-1" center holes on 3M™ Inline Sanders	Part 300	See MOS of wheel	1
<b>For 3M™ Match and Finish Sander</b>					
<b>3M™ Rubber Slotted Expander Wheel</b> 	051141-28718-8	Rubber slotted expander wheel for use with 3-1/2" x 15-1/2" belts	5" x 3-1/2" x 1" AH	3,500	1
<b>3M™ Rubber Slotted Expander Adapter Kit</b> 	051141-28719-5	Inline sander, bench grinders, bench motors, benchtop tools	1" x 5/8-11 INT	3,500	1

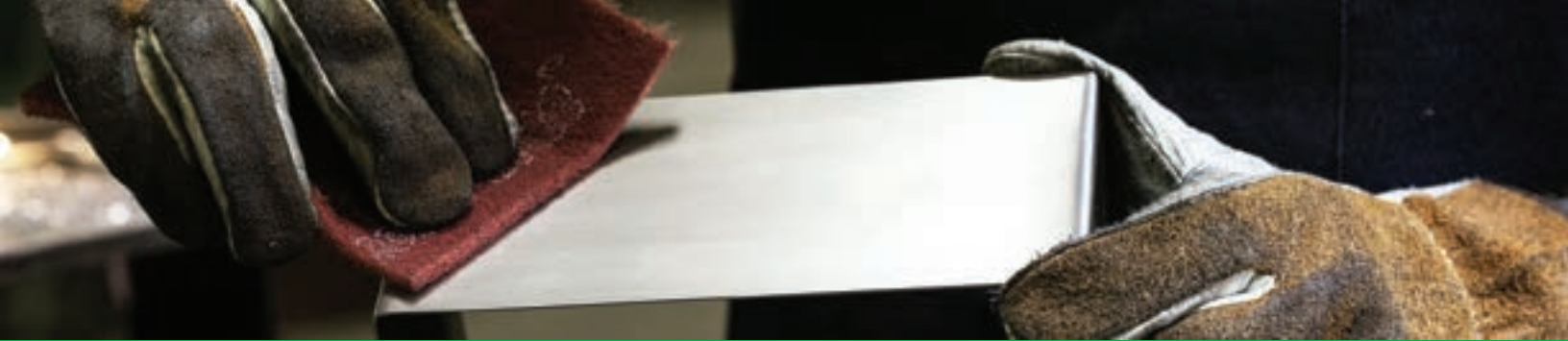

# Hand Finishing

## 3M™ Abrasive Sheets

### 3M™ Utility Cloth Sheet and Roll Selection Guide

A good choice for all your utility sanding and general maintenance work. Can be torn and rolled without shelling.

Product ID	Mineral	Backing	Features	Performance	Blending	Finishing	Cleaning
314D	Premium Aluminum Oxide	Durable Cloth	Strong bonding system for shelling resistance	Good	●	●	●
211K	Aluminum Oxide	Flexible Utility Cloth	Use for all general maintenance work	Good		●	
011K	Aluminum Oxide	Flexible Utility Cloth	Closed Coat; General purpose use	Good	●	●	●

### 3M™ Wetordry™ Sheet Selection Guide

Still a favorite for their reduced clogging, long life and great finish. Good general use sheet for hand or machine sanding. Can be run wet or dry.

Product ID	Mineral	Backing	Blending	Finishing
431Q	Silicon Carbide	C wt Paper	●	
		A wt Paper		●

### 3M™ Paper Sheet Selection Guide

Conformable and versatile, 3M™ Paper Sheets are ideal for hand or machine sanding. Various constructions available for use on wood, metal, paint, plastic and fiberglass.

Product ID	Mineral	Backing	Performance	Blending
346U	Aluminum Oxide	D wt Paper	Good	●
336U	Aluminum Oxide	C wt Paper	Good	●

# Scotch-Brite™ Hand Pads

Scotch-Brite™ Hand Pads give you a fast, consistent scuff for everyday surface preparation. Ideal for cleaning parts and scuffing prior to staining and painting. Also a great alternative to steel wool — similar performance without the rusting or splintering.

## Scotch-Brite™ Hand Pad Selection Guide

Performance	Blending	Finishing	Cleaning
Premium	7447/7448 PRO	7447/7448 PRO	8447/Durable Flex
Premium	7440, 8447	7440	7447, 7447 PRO
Premium	7446, 7447	7446	8447

Less Aggressive/Finer Finish

More Aggressive/Coarser Finish

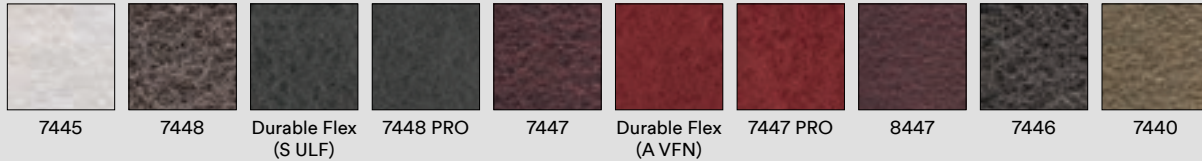

### Scotch-Brite™ Light Duty Cleansing Pad 7445

- Very mild abrasive for gentle, yet thorough cleaning
- Commonly used with liquid detergent
- Performance similar to steel wool grade 0000



UPC	W x L	Grade	Color	Qty/Case
048011-16976-7	6" x 9"	F SFN	White	60

### Scotch-Brite™ Ultra Fine Hand Pad 7448

- Ultra fine consistent finishes on metals, woods, plastics and composites
- Performance similar to steel wool grade 00



UPC	W x L	Grade	Color	Qty/Case
048011-04028-8	6" x 9"	S ULF	Gray	60

### Scotch-Brite™ Hand Pads 7448 PRO

- High performance pad takes less time to prep surface and lasts longer
- Tightly graded abrasive particles for consistent, uniform scratch throughout life of the hand pad
- New, long lasting pad made with durable non-woven nylon web is flexible enough to get into hard-to-sand places; Specially coated to minimize loading
- Ideal for everyday uses like prepping surfaces for color coat; general scuffing, cleaning and hand blending
- Center perforated for convenience

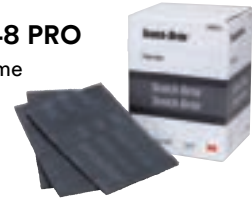

UPC	W x L	Grade	Color	Qty/Case
048011-64935-1	6" x 9"	S ULF	Gray	60
048011-64933-7	Trial Pack: Includes one each: 7447 PRO and 7448 PRO			

### Scotch-Brite™ General Purpose Hand Pad 7447

- Worldwide standard for surface conditioning
- Clean, blend, finish and deburr faster, easier, and with better results than conventional abrasives
- Performance similar to steel wool grade 1



UPC	W x L	Grade	Color	Qty/Case
048011-04029-5	6" x 9"	A VFN	Maroon	60

## Scotch-Brite™ Hand Pads

### Scotch-Brite™ Hand Pads 7447 PRO

- High performance pad takes less time to prep surface and lasts longer
- Tightly graded abrasive particles for consistent, uniform scratch throughout life of the hand pad
- New, long lasting pad made with durable non-woven nylon web is flexible enough to get into hard-to-sand places; Specially coated to minimize loading
- Ideal for everyday uses like prepping surfaces for color coat; general scuffing, cleaning and hand blending
- Center perforated for convenience



UPC	W x L	Grade	Color	Qty/Case
048011-64926-9	6" x 9"	A VFN	Maroon	60
048011-64933-7	Trial Pack: Includes one each: 7447 PRO and 7448 PRO			

### Scotch-Brite™ Durable Flex Hand Pads

- High performance pads are packed with tightly graded abrasive mineral for more consistent, fast cut
- Flexible pad cleans, blends and finishes where conformability is needed
- Ideal for prepping surfaces for primer and color coat, general scuffing, cleaning and hand blending
- S Ultra Fine (S ULF) produces a finish similar to steel wool grade 00
- A Very Fine (A VFN) produces a finish similar to steel wool grade 1

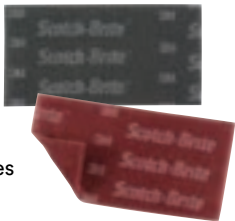

UPC	W x L	Grade	Color	Qty/Case
048011-64659-6	4-1/2" x 9"	A VFN	Maroon	100
048011-64660-2	4-1/2" x 9"	S ULF	Gray	100

### Scotch-Brite™ Production Hand Pad 8447

- High cut for paint prep, blending and scuffing
- Long life performance on aluminum, stainless steel, plastics, wood and fiberglass
- Performance similar to steel wool grade 2



UPC	W x L	Grade	Color	Qty/Case
048011-24037-4	6" x 9"	A VFN	Maroon	60

### Scotch-Brite™ Blending Hand Pad 7446

- Specially designed for hand blending and finishing stainless steel
- Mineral coarseness blends surface scratches on many metals, wood and synthetic surfaces
- Performance similar to steel wool grade 3



UPC	W x L	Grade	Color	Qty/Case
048011-65056-2	6" x 9"	S MED	Gray	40

### Scotch-Brite™ Heavy Duty Hand Pad 7440

- Most durable and aggressive pad for quick stock removal
- Cuts fast to remove contaminants and oxides in demanding cleaning and finishing applications
- Performance similar to steel wool grade 4



UPC	W x L	Grade	Color	Qty/Case
048011-65055-5	6" x 9"	A MED	Gray	40

## Scotch-Brite™ Hand Pad Trial Packs

### Scotch-Brite™ Hand Pad Trial Pack 7447 PRO and 7448 PRO

- Contains 1 each of the following:
  - Scotch-Brite™ Hand Pad 7447 PRO (Maroon)
  - Scotch-Brite™ Hand Pad 7448 PRO (Gray)



UPC	Size	Min/Case
048011-64933-7	6" x 9"	20 packs/case

### Scotch-Brite™ Hand Pad Trial Pack 961S

- Contains 1 each of the following:
  - Scrubbing Sponge 74
  - Light Duty Pad 6448
  - Heavy Duty Pad 7440
  - Light Duty Cleansing Pad 7445
  - Blending Pad 7446
  - General Purpose Pad 7447
  - Ultra Fine Pad 7448
  - Production Pad 8447
  - Twist-Lok™ Pad Holder 961



UPC	Size	Min/Case
048011-17144-9	6" x 9"	5



# Scotch-Brite™ Rolls

## Scotch-Brite™ Hand Finishing Selection Guide

Performance	Blending	Finishing	Cleaning
Premium	7447/7448 PRO/Durable Flex	7447/7448 PRO/Durable Flex	Durable Flex
Premium	—	—	High Strength A MED
Premium	Cut and Polish	Production Clean and Finish	Clean and Finish
Premium	Clean and Finish	Clean and Finish	Production Clean and Finish

### Scotch-Brite™ Production Clean and Finish Rolls

- Precision web/mineral configuration for most uniform general purpose finishing in roll form

- Excellent for critical finishes and long life



UPC	W x L	Grade	Color	Qty/Case
048011-28175-9†	4" x 30'	A VFN	Maroon	3
048011-28176-6†	6" x 30'	A VFN	Maroon	2

†Made-to-Order

### Scotch-Brite™ 7447/7448 PRO Rolls

- High performance abrasive takes less time to prep surface and lasts longer
- Tightly graded abrasive particles for consistent, uniform scratch throughout life of the abrasive
- New, long lasting pad made with durable non-woven nylon web is flexible enough to get into hard-to-sand places; Specially coated to minimize loading
- Ideal for everyday uses like prepping surfaces for color coat; general scuffing, cleaning and hand blending

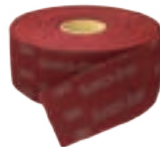

UPC	W x L	Grade	Color	Qty/Case
048011-64964-1†	Belt sizes made to order; specify UPC, grade and belt size (W" x L")	S ULF	Gray	Determined by roll size
048011-64956-6†		A VFN	Maroon	

†Made-to-Order

### Scotch-Brite™ High Strength Rolls

- Non-woven, open web abrasive stock designed to clean, denib, defuzz, and produce satin finishes
- Durable to stand up to heavy duty use
- The flexible material folds, stacks, or rolls to accommodate various contours and hard-to-reach areas



UPC	W x L	Grade	Qty/Case
048011-16804-3†	4" x 30'	A MED	3
048011-09146-4†	6" x 30'	A MED	2
048011-05213-7	4" x 30'	A VFN	3
048011-05359-2	6" x 30'	A VFN	2
048011-92426-7†	Generic	A FIN	Varies
048011-91512-8†	Generic	S VFN	Varies

†Made-to-Order

### Scotch-Brite™ Clear Blend Prep Scuff 7745

- Ideal for top coat rubbing, sealer sanding prior to lacquer, and defuzzing or denibbing wood

- Performance similar to steel wool grade 000



UPC	W x L	Grade	Color	Qty/Case
051131-07745-4	4-3/4" x 15'	A ULF	Gold	3

### Scotch-Brite™ Cut and Polish Rolls

- A unique and aggressive material for cleaning and finishing
- Sturdy, long lasting web material is great for heavy industrial cleaning and light deburring applications
- Works well for stropping and other bench applications



UPC	W x L	Grade	Qty/Case
048011-04085-1	1" x 30'	A MED	12
048011-05206-9	2" x 30'	A MED	6
048011-05207-6	4" x 30'	A MED	3

### Scotch-Brite™ Clean and Finish Rolls

- Highly conformable non-woven web can be cut to desired length for hand sanding or oscillating sanders



UPC	W x L	Grade	Qty/Case
048011-00291-0†	2" x 30'	A FIN	6
048011-00260-6	2" x 30'	A VFN	6
048011-00261-3	3" x 30'	A VFN	4
048011-00264-4	4" x 30'	A MED	3
048011-00265-1	4" x 30'	A FIN	3
048011-00266-8	4" x 30'	A VFN	3
048011-00270-5	4" x 30'	S VFN	3
048011-00263-7	4" x 30'	F SFN	3
048011-00267-5	4" x 30'	S SFN	3
048011-00268-2	4" x 30'	S ULF	3
048011-00262-0	4" x 30'	TALC	3
048011-00274-3	6" x 30'	A MED	2
048011-00275-0	6" x 30'	A FIN	2
048011-00276-7	6" x 30'	A VFN	2
048011-00284-2	12" x 30'	A VFN	1
048011-00254-5	12" x 30'	TALC	1

†Made-to-Order

# 3M™ Abrasive Sheets

## 3M™ Utility Cloth Sheets 011K

- Aluminum oxide mineral
- General purpose use



UPC	W x L	Grade	Min/Case
<b>Sheets</b>			
051144-02433-9	9" x 11"	CRS	50/250
051144-02432-2	9" x 11"	MED	50/250
051144-02431-5	9" x 11"	FINE	50/250

## 3M™ Utility Cloth Sheets and Rolls 211K

- Aluminum oxide on a J wt cloth backing
- Use these flexible utility rolls and sheets for general applications such as deburring, rust removal, strapping and all general maintenance work



UPC	W x L	Grade	Min/Case
<b>Sheets</b>			
051144-02410-0	9" x 11"	80	50/250
051144-02409-4	9" x 11"	100	50/250
051144-02408-7	9" x 11"	120	50/250
051144-02407-0	9" x 11"	150	50/250
051144-02406-3	9" x 11"	180	50/250
051144-02405-6	9" x 11"	220	50/250
051144-02404-9	9" x 11"	240	50/250
051144-02402-5	9" x 11"	320	50/250
051144-12501-2	9" x 11"	400	50/250
051144-12500-5	9" x 11"	500	50/250
<b>Utility Rolls</b>			
051144-05010-9	1" x 50 yds	80	1/5
051144-05009-3	1" x 50 yds	100	1/5
051144-05008-6	1" x 50 yds	120	1/5
051144-05007-9	1" x 50 yds	150	1/5
051144-05006-2	1" x 50 yds	180	1/5
051144-05005-5	1" x 50 yds	220	1/5
051144-05004-8	1" x 50 yds	240	1/5
051144-05002-4	1" x 50 yds	320	1/5
051144-05001-7	1" x 50 yds	400	1/5
051144-05000-0	1" x 50 yds	500	1/5
051144-05030-7	1-1/2" x 50 yds	80	1/5
051144-05029-1	1-1/2" x 50 yds	100	1/5
051144-05028-4	1-1/2" x 50 yds	120	1/5
051144-05027-7	1-1/2" x 50 yds	150	1/5
051144-05026-0	1-1/2" x 50 yds	180	1/5
051144-05025-3	1-1/2" x 50 yds	220	1/5
051144-05024-6	1-1/2" x 50 yds	240	1/5
051144-05022-2	1-1/2" x 50 yds	320	1/5
051144-05021-5	1-1/2" x 50 yds	400	1/5
051144-05020-8	1-1/2" x 50 yds	500	1/5

## 3M™ Utility Cloth Sheets and Rolls 211K (cont)

UPC	W x L	Grade	Min/Case
<b>Utility Rolls</b>			
051144-05050-5	2" x 50 yds	80	1/5
051144-05049-9	2" x 50 yds	100	1/5
051144-05048-2	2" x 50 yds	120	1/5
051144-05047-5	2" x 50 yds	150	1/5
051144-05046-8	2" x 50 yds	180	1/5
051144-05045-1	2" x 50 yds	220	1/5
051144-05044-4	2" x 50 yds	240	1/5
051144-05042-0	2" x 50 yds	320	1/5
051144-05041-3	2" x 50 yds	400	1/5
051144-05040-6	2" x 50 yds	500	1/5

## 3M™ Utility Cloth Sheets and Rolls 314D

- Aluminum oxide on X and J wt cloth backings
- Ideal for all utility jobs
- Can be torn into strips and rolled without shelling



UPC	W x L	Grade	Backing	Min/Case
<b>Sheets</b>				
051115-19775-8	9" x 11"	P40	X wt	50/250
051115-19774-1	9" x 11"	P50	X wt	50/250
051115-19773-4	9" x 11"	P60	X wt	50/250
051115-19772-7	9" x 11"	P80	J wt	50/250
051115-19771-0	9" x 11"	P100	J wt	50/250
051115-19770-3	9" x 11"	P120	J wt	50/250
051115-19769-7	9" x 11"	P150	J wt	50/250
051115-19768-0	9" x 11"	P180	J wt	50/250
051115-19767-3	9" x 11"	P220	J wt	50/250
051115-19766-6	9" x 11"	P240	J wt	50/250
051115-19765-9	9" x 11"	P280	J wt	50/250
051115-19764-2	9" x 11"	P320	J wt	50/250
051115-19763-5	9" x 11"	P400	J wt	50/250
<b>Utility Rolls</b>				
051115-19794-9	1" x 50 yds	P50	X wt	1/5
051115-19793-2	1" x 50 yds	P60	X wt	1/5
051115-19792-5	1" x 50 yds	P80	J wt	1/5
051115-19791-8	1" x 50 yds	P100	J wt	1/5
051115-19790-1	1" x 50 yds	P120	J wt	1/5
051115-19789-5	1" x 50 yds	P150	J wt	1/5
051115-19788-8	1" x 50 yds	P180	J wt	1/5
051115-19787-1	1" x 50 yds	P220	J wt	1/5
051115-19786-4	1" x 50 yds	P240	J wt	1/5
051115-19785-7	1" x 50 yds	P280	J wt	1/5
051115-19784-0	1" x 50 yds	P320	J wt	1/5
051115-19783-3	1" x 50 yds	P400	J wt	1/5
051115-19813-7	1-1/2" x 50 yds	P50	X wt	1/5
051115-19812-0	1-1/2" x 50 yds	P60	X wt	1/5

Chart continued on next page

## 3M™ Abrasive Sheets

### 3M™ Utility Cloth Sheets and Rolls 314D (cont)

UPC	W x L	Grade	Backing	Min/Case
<b>Utility Rolls</b>				
051115-19811-3	1-1/2" x 50 yds	P80	J wt	1/5
051115-19810-6	1-1/2" x 50 yds	P100	J wt	1/5
051115-19809-0	1-1/2" x 50 yds	P120	J wt	1/5
051115-19808-3	1-1/2" x 50 yds	P150	J wt	1/5
051115-19807-6	1-1/2" x 50 yds	P180	J wt	1/5
051115-19806-9	1-1/2" x 50 yds	P220	J wt	1/5
051115-19805-2	1-1/2" x 50 yds	P240	J wt	1/5
051115-19804-5	1-1/2" x 50 yds	P280	J wt	1/5
051115-19803-8	1-1/2" x 50 yds	P320	J wt	1/5
051115-19802-1	1-1/2" x 50 yds	P400	J wt	1/5
051115-19826-7	2" x 50 yds	P40	X wt	1/5
051115-19825-0	2" x 50 yds	P50	X wt	1/5
051115-19824-3	2" x 50 yds	P60	X wt	1/5
051115-19823-6	2" x 50 yds	P80	J wt	1/5
051115-19822-9	2" x 50 yds	P100	J wt	1/5
051115-19821-2	2" x 50 yds	P120	J wt	1/5
051115-19820-5	2" x 50 yds	P150	J wt	1/5
051115-19819-9	2" x 50 yds	P180	J wt	1/5
051115-19818-2	2" x 50 yds	P220	J wt	1/5
051115-19817-5	2" x 50 yds	P240	J wt	1/5
051115-19816-8	2" x 50 yds	P280	J wt	1/5
051115-19815-1	2" x 50 yds	P320	J wt	1/5
051115-19814-4	2" x 50 yds	P400	J wt	1/5

### 3M™ Wetordry™ Sheets 413Q

- Silicon carbide on an A wt paper backing
- Reduced clogging eliminates dust when used wet
- Excellent conformability



UPC	W x L	Grade	Min/Case
051144-02007-2	9" x 11"	220	50/500
051144-02006-5	9" x 11"	240	50/250
051144-02005-8	9" x 11"	280	50/250
051144-02004-1	9" x 11"	320	50/500
051144-02003-4	9" x 11"	360	50/250
051144-02002-7	9" x 11"	400	50/500

### 3M™ Wetordry™ Paper Sheets 431Q

- Silicon carbide on a C wt paper backing
- Reduced clogging eliminates dust when used wet
- Heavyweight paper backing for increased durability



UPC	W x L	Grade	Min/Case
051144-02018-8	9" x 11"	80	50/250
051144-02017-1	9" x 11"	100	50/250
051144-02016-4	9" x 11"	120	50/250
051144-02015-7	9" x 11"	150	50/250
051144-02014-0	9" x 11"	180	50/250



### 3M™ Paper Sheets 336U/346U

- Aluminum oxide on D wt (grades 36–80) and C wt (grades 100–150) paper backing
- Open coat resists loading on soft materials
- General purpose sheets ideal for hand or machine sanding of many different materials, including wood, metals, paints, plastics and fiberglass

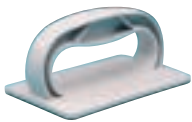

UPC	W x L	Grade	Min/Case
<b>336U</b>			
051144-02114-7	9" x 11"	100	100/1000
051144-02113-0	9" x 11"	120	100/1000
051144-02112-3	9" x 11"	150	100/1000
<b>346U</b>			
051144-02119-2	9" x 11"	36	50/250
051144-02118-5	9" x 11"	40	50/250
051144-02117-8	9" x 11"	50	50/500
051144-02116-1	9" x 11"	60	50/500
051144-02115-4	9" x 11"	80	50/500

## Accessories: Hand Finishing

Product	UPC	For Use With	Size/Description	Max RPM	Qty/Case
<b>Forked Spindle</b> 	051144-45121-0	For attaching utility cloth strips	3" x 1/16" x 3/4" x 1/4"	N/A	10
<b>3M™ Wetordry™ Sponge Pad</b> 	051131-05526-1	Wetordry™ Paper Sheets	2-3/4" x 5-1/2" x 3/8"	N/A	50
<b>3M™ Stikit™ Soft Hand Pad</b> 	051144-05530-2	Stikit™ Sheet Rolls	2-3/4" x 5-1/2" x 3/8"	N/A	5/10
<b>Scotch-Brite™ Pad Holder 961</b> 	048011-09493-4	Scotch-Brite™ Hand Pads; Provides increased leverage and eliminates "finger" marks	3-1/2" x 2-1/2" x 4-3/4"	N/A	10
<b>Mini Mandrel 935</b> 	048011-04020-2	Scotch-Brite™ Strips to clean and polish inner diameters and other tight areas	2-7/8" x 1/4"	14,000	5

# Specialty Abrasives

## 3M™ Cartridge Rolls

Cartridge rolls are ideal for getting into small, hard to reach spaces. As they wear, the wrapped layers of the cartridge roll continuously expose fresh abrasive layers for continued cutting action. Available in regular and tapered construction.

### 3M™ Cartridge Rolls 341D

- Aluminum oxide on an X wt cloth backing
- Long life and fast cut
- General purpose cartridge rolls at a value price



UPC	Dia x L x CH	Grade	Max RPM	Qty/Case
<b>Regular</b>				
051144-96959-3	1/4" x 1" x 1/8"	P60	24,000	100
051144-14021-3	1/4" x 1" x 1/8"	P80	24,000	100
051144-96961-6	1/4" x 1" x 1/8"	P120	24,000	100
051144-96963-0	1/4" x 1" x 1/8"	P180	24,000	100
051144-96968-5	1/4" x 1-1/2" x 1/8"	P60	24,000	100
051144-96969-2	1/4" x 1-1/2" x 1/8"	P80	24,000	100
051144-96971-5	1/4" x 1-1/2" x 1/8"	P120	24,000	100
051144-96973-9	1/4" x 1-1/2" x 1/8"	P180	24,000	100
051144-14024-4	3/8" x 1" x 1/8"	P60	24,000	100
051144-14023-7	3/8" x 1" x 1/8"	P80	24,000	100
051144-14022-0	3/8" x 1" x 1/8"	P120	24,000	100
051144-97008-7	3/8" x 1" x 1/8"	P180	24,000	100
051144-97013-1	3/8" x 1-1/2" x 1/8"	P60	24,000	100
051144-97015-5	3/8" x 1-1/2" x 1/8"	P120	24,000	100
051144-97017-9	3/8" x 1-1/2" x 1/8"	P180	24,000	100
051144-97041-4	1/2" x 1" x 1/8"	P60	24,000	100
051144-97042-1	1/2" x 1" x 1/8"	P80	24,000	100
051144-97044-5	1/2" x 1" x 1/8"	P120	24,000	100
051144-14028-2	1/2" x 1-1/2" x 1/8"	P60	24,000	100
051144-14027-5	1/2" x 1-1/2" x 1/8"	P80	24,000	100
051144-14026-8	1/2" x 1-1/2" x 1/8"	P120	24,000	100
051144-97059-9	1/2" x 1-1/2" x 1/8"	P180	24,000	100
051144-97162-6	3/4" x 1-1/2" x 3/16"	P60	16,000	100
051144-97163-3	3/4" x 1-1/2" x 3/16"	P80	16,000	100
051144-97165-7	3/4" x 1-1/2" x 3/16"	P120	16,000	100

### 3M™ Cartridge Rolls 341D (cont)

UPC	Dia x L x CH	Grade	Max RPM	Qty/Case
<b>Full Taper</b>				
051144-97239-5	3/8" x 1" x 1/8"	P60	24,000	100
051144-97240-1	3/8" x 1" x 1/8"	P80	24,000	100
051144-97242-5	3/8" x 1" x 1/8"	P120	24,000	100
051144-97244-9	3/8" x 1" x 1/8"	P180	24,000	100
051144-97248-7	3/8" x 1-1/2" x 1/8"	P60	24,000	100
051144-97249-4	3/8" x 1-1/2" x 1/8"	P80	24,000	100
051144-97251-7	3/8" x 1-1/2" x 1/8"	P120	24,000	100
051144-97257-9	1/2" x 1" x 1/8"	P60	24,000	100
051144-97259-3	1/2" x 1" x 1/8"	P120	24,000	100
051144-14034-3	1/2" x 1-1/2" x 1/8"	P60	24,000	100
051144-14033-6	1/2" x 1-1/2" x 1/8"	P80	24,000	100
051144-14032-9	1/2" x 1-1/2" x 1/8"	P120	24,000	100
051144-97267-8	1/2" x 1-1/2" x 1/8"	P180	24,000	100

### 3M™ Cartridge Rolls 747D

- 3M ceramic aluminum oxide blend abrasive grain on an X wt cloth backing
- Long life and fast cut
- Contains grinding aid for cooler cutting on heat sensitive alloys



UPC	Dia x L x CH	Grade	Max RPM	Qty/Case
<b>Regular</b>				
051144-80790-1	1/2" x 1-1/2" x 1/8"	60	24,000	100
051144-80796-3	1/2" x 1-1/2" x 1/8"	80	24,000	50
051144-80792-5	1/2" x 1-1/2" x 1/8"	P120	24,000	100
<b>Full Taper</b>				
051144-80786-4	1/2" x 1-1/2" x 1/8"	60	24,000	100
051144-80787-1	1/2" x 1-1/2" x 1/8"	80	24,000	100
051144-80788-8	1/2" x 1-1/2" x 1/8"	P120	24,000	100

## 3M™ Square and Cross Pads

Square pads are ideal for fast grinding/blending of channels, fillets, corners and spotting on flat surfaces. As the square pads rotate, the corners exert a fast biting action and gradually wear down to expose fresh abrasive material. Cross pads are used for close tolerance polishing of small radii and channels, deburring the ends and insides of tubing and other special applications.

### 3M™ Square Pads 341D

- Premium aluminum oxide on an X wt cloth backing
- Long life and fast cut
- General purpose pads at a value price



UPC	Size	Grade	Max RPM	Min/Case
<b>1/4–20 Eyelet</b>				
051141-27353-2†	2" x 2" x 3/8"	60	12,000	50/100
051141-27354-9†	2" x 2" x 3/8"	80	12,000	50/100
051141-27355-6†	2" x 2" x 3/8"	P120	12,000	50/100
051141-27350-1	2" x 2" x 1/2"	60	12,000	50/100
051141-27351-8	2" x 2" x 1/2"	80	12,000	50/100
051141-27352-5	2" x 2" x 1/2"	P120	12,000	50/100
051144-97723-9	3" x 3" x 1/4"	P120	9,000	50/100
051141-27356-3†	3" x 3" x 1/2"	60	9,000	50/100
051141-27357-0†	3" x 3" x 1/2"	80	9,000	50/100
051141-27358-7†	3" x 3" x 1/2"	P120	9,000	50/100

†Made-to-Order

### 3M™ Square Pads 747D

- 3M ceramic aluminum oxide blend abrasive grain on an X wt cloth backing
- Super aggressive cut rate and durability
- Contains grinding aid for cooler cutting on heat sensitive alloys



UPC	Size	Grade	Max RPM	Min/Case
<b>1/4–20 Eyelet</b>				
051141-27361-7†	2" x 2" x 1/2"	P120	7,000	50/100
051141-27363-1†	2" x 2" x 3/8"	80	7,000	50/100
051141-27364-8†	2" x 2" x 3/8"	P120	7,000	50/100
051141-27365-5†	3" x 3" x 1/2"	60	6,000	50/100
051141-27366-2†	3" x 3" x 1/2"	80	6,000	50/100
051141-27367-9†	3" x 3" x 1/2"	P120	6,000	50/100

†Made-to-Order

### 3M™ Cross Pads 341D

- Premium aluminum oxide on an X wt cloth backing
- Long life and fast cut
- General purpose pads at a value price



UPC	Size	Grade	Max RPM	Min/Case
<b>8 or 10 Ply; 8–32 Eyelet</b>				
051141-27368-6	1" x 1" x 3/8"	60	18,000	50/100
051141-27369-3	1" x 1" x 3/8"	80	18,000	50/100
051141-27370-9†	1" x 1" x 3/8"	P120	18,000	50/100
051141-27371-6	1-1/2" x 1-1/2" x 1/2"	60	18,000	50/100
051141-27372-3	1-1/2" x 1-1/2" x 1/2"	80	18,000	50/100
051141-27373-0	1-1/2" x 1-1/2" x 1/2"	P120	18,000	50/100
051144-97783-3	6" x 6" x 1-1/2"	60	9,000	50

#### 8 Ply; 1/4–20 Eyelet

051141-27374-7	2" x 2" x 1/2"	60	15,000	50/100
051141-27375-4	2" x 2" x 1/2"	80	15,000	50/100
051141-27376-1	2" x 2" x 1/2"	P120	15,000	50/100
051141-27378-5	2" x 2" x 3/4"	80	15,000	50/100
051141-27379-2	2" x 2" x 3/4"	P120	15,000	50/100
051144-97750-5	2-1/2" x 2-1/2" x 3/4"	60	15,000	50/100

#### 8 or 10 Ply; 1/4–20 Eyelet

051141-27380-8	3" x 3" x 1"	60	15,000	50/100
051141-27381-5	3" x 3" x 1"	80	15,000	50/100
051141-27382-2†	3" x 3" x 1"	P120	15,000	50/100
051144-97766-6	3-1/2" x 3-1/2" x 1-1/2"	80	12,000	50/100

#### 8 Ply; 8–32 Eyelet

051144-97768-0	4" x 4" x 1"	60	12,000	50/100
----------------	--------------	----	--------	--------

†Made-to-Order

### 3M™ Cross Pads 747D

- 3M ceramic aluminum oxide blend abrasive grain on an X wt cloth backing
- Super aggressive cut rate and durability
- Contains grinding aid for cooler cutting on heat sensitive alloys



UPC	Size	Grade	Max RPM	Min/Case
<b>8 Ply; 1/4–20 Eyelet</b>				
051141-20369-0	1-1/2" x 1-1/2" x 1/2"	80	18,000	100
051141-20372-0	1-1/2" x 1-1/2" x 1/2"	P100	18,000	100
051141-20375-1	2" x 2" x 3/4"	80	15,000	100

## 3M™ Bands

Great for getting at those hard to reach places and contours. Ideal for removing parting lines, imperfections and burrs. Use with 3M™ Die Grinders and 3M™ Rubber Slotted Expander Wheel or 3M™ Rubber Cushion Polishing Wheel.

### 3M™ Bands 341D

- Aluminum oxide on and X wt cloth backing
- Fast cut and long life
- General purpose evenrun bands at a value price



UPC	Dia x W	Grade	Max RPM	Qty/Case
051144-40243-4	1/4" x 1/2"	P80	23,000	100
051144-97428-3	1/4" x 1/2"	P120	23,000	100
051144-40228-1	1/2" x 1/2"	P60	30,000	100
051144-40227-4	1/2" x 1/2"	P80	30,000	100
051144-40252-6	1/2" x 1/2"	P120	30,000	100
051144-97458-0	1/2" x 1"	P36	15,000	100
051144-40225-0	1/2" x 1"	P60	15,000	100
051144-40224-3	1/2" x 1"	P80	15,000	100
051144-11973-8	1/2" x 1"	P120	15,000	100
051144-11976-9	3/4" x 1"	P36	17,000	100
051144-40221-2	3/4" x 1"	P60	17,000	100
051144-40220-5	3/4" x 1"	P80	17,000	100
051144-40219-9	3/4" x 1"	P120	17,000	100
051144-11977-6	3/4" x 1-1/2"	P36	10,000	100
051144-40241-0	3/4" x 1-1/2"	P80	10,000	100
051144-40214-4	1" x 1"	P36	18,000	100
051144-40211-3	1" x 1"	P60	18,000	100
051144-40210-6	1" x 1"	P80	18,000	100
051144-40208-3	1" x 1"	P120	18,000	100
051144-40207-6	1" x 1-1/2"	P36	10,000	100
051144-11980-6	1" x 1-1/2"	P60	10,000	100
051144-40205-2	1" x 1-1/2"	P80	10,000	100
051144-40203-8	1-1/2" x 1"	P36	14,000	100
051144-40202-1	1-1/2" x 1"	P60	14,000	100
051144-40200-7	1-1/2" x 1-1/2"	P36	10,000	100
051144-40197-0	1-1/2" x 1-1/2"	P60	10,000	100
051144-40196-3	1-1/2" x 1-1/2"	P80	10,000	100
051144-40274-8	1-1/2" x 1-1/2"	P120	10,000	100
051144-40267-0	1-1/2" x 2"	P60	8,000	100
051144-40184-0	2" x 2"	P60	6,000	100
051144-40183-3	2" x 2"	P80	6,000	100
051144-40178-9	3" x 3"	P36	3,000	50
051144-40175-8	3" x 3"	P60	3,000	50
051144-40174-1	3" x 3"	P80	3,000	50
051144-40172-7	3" x 3"	P120	3,000	50

### 3M™ Bands 747D

- 3M ceramic aluminum oxide blend abrasive grain on an X wt cloth backing
- Long life and fast cut
- Contains grinding aid for cooler cutting on heat sensitive alloys



UPC	Dia x W	Grade	Max RPM	Qty/Case
051144-80765-9	1/2" x 1"	50	15,000	100
051144-80769-7	1/2" x 1"	60	15,000	100
051144-80773-4	1/2" x 1"	80	15,000	100
051144-80766-6	1" x 1"	50	18,000	100
051144-80770-3	1" x 1"	60	18,000	100
051144-80774-1	1" x 1"	80	18,000	100
051144-80782-6	1" x 1"	P120	18,000	100
051144-80771-0	2" x 1"	60	11,000	100
051144-80775-8	2" x 1"	80	11,000	100
051144-80783-3	2" x 1"	P120	11,000	100

# Scotch-Brite™ Specialty Abrasives

Make tough jobs easy with these Scotch-Brite™ specialty abrasives. Unique constructions for use on contours and flat areas — on metal, wood, paint, coatings and more.

## Scotch-Brite™ EXL Unitized Mounted Points

- EXL unitized material dressed to six different ANSI shapes for delicate deburring and finishing of critical parts

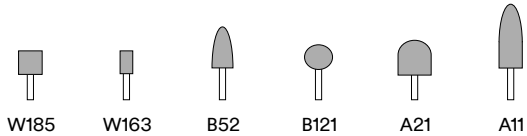

UPC	Size	Shape	Density	Grade	Qty/Case
<b>1/4" Shank</b>					
048011-64794-4	7/8" x 2" x 1/4"	A11	8	A MED	50
048011-64795-1	7/8" x 2" x 1/4"	A11	8	S FIN	50
048011-64796-8	1" x 1" x 1/4"	A21	8	A MED	50
048011-64797-5	1" x 1" x 1/4"	A21	8	S FIN	50
<b>1/8" Shank</b>					
048011-64798-2	1/2" x 1/2" x 1/8"	B121	8	A MED	50
048011-64799-9	1/2" x 1/2" x 1/8"	B121	8	A CRS	50
048011-64800-2	3/8" x 3/4" x 1/8"	B52	8	A CRS	50
048011-64801-9	3/8" x 3/4" x 1/8"	B52	8	A MED	50
048011-64802-6	3/8" x 3/4" x 1/8"	B52	8	S FIN	50
048011-64803-3	1/4" x 1/2" x 1/8"	W163	8	A CRS	50
048011-64804-0	1/4" x 1/2" x 1/8"	W163	8	S FIN	50
048011-64805-7	1/4" x 1/2" x 1/8"	W163	8	A MED	50
048011-64806-4	1/2" x 1/2" x 1/8"	W185	8	A CRS	50
048011-64807-1	1/2" x 1/2" x 1/8"	W185	8	A MED	50
048011-64808-8	1/2" x 1/2" x 1/8"	W185	8	S FIN	50

## Scotch-Brite™ Radial Bristle Brush, TA

- Excellent replacement for wire brushes
- Use on bench motors for general purpose cleaning applications
- No flying wires yet higher cut rates
- Very strong and flexible
- Comes with adapters for multiple shaft sizes (1/2", 5/8", 3/4", 7/8", 1", 2" and 8")



UPC	Dia x W	Grade	Color	Max RPM	Qty/Case
048011-24279-8	3" x 3/8"	50	Green	25,000	40
048011-24280-4	3" x 3/8"	80	Yellow	25,000	40
048011-24281-1	3" x 3/8"	120	White	25,000	40
048011-27603-8	6" x 1/2" x 1"	36	Brown	6,000	5
048011-27605-2	6" x 1/2" x 1"	50	Green	6,000	5
048011-27606-9	6" x 1/2" x 1"	80	Yellow	6,000	5

## Scotch-Brite™ Flap Brush CPFB-S and CPFB-R+

- Heavy-duty brush
- Excellent for removing handling marks and surface imperfections
- Available on 1/4" shaft (CPFB-S) or 3M™ Roloc™+ attachment system (CPFB-R+)



UPC	Dia x W x Shaft	Grade	Max RPM	Qty/Case
<b>CPFB-S</b>				
048011-16622-3	2" x 1" x 1/4"	A MED	12,000	25
048011-05974-7	3" x 1-3/4" x 1/4"	A MED	8,500	10
<b>CPFB-R+</b>				
048011-14588-4	3" x 1-3/8"	A MED	8,000	10

## Scotch-Brite™ Flap Brush CFFB-S

- Ideal for decorative finishes and light deburring applications
- Available on 1/4" shaft (CFFB-S)



UPC	Dia x W x Shaft	Grade	Max RPM	Qty/Case
048011-05975-4	3" x 1-3/4" x 1/4"	A CRS	8,500	10
048011-14781-9	3" x 1-3/4" x 1/4"	S FIN	8,500	10

## Scotch-Brite™ Combi Wheel, Combi-S

- Made of alternating flaps of coated abrasive and Scotch-Brite™ web
- Provides aggressive cut and fine finishes



UPC	Dia x W x Shaft	Grade	Max RPM	Qty/Case
<b>CFFB-S</b>				
051144-80801-4	3" x 1-3/4" x 1/4"	80	8,000	10
051144-80678-2	3" x 1-3/4" x 1/4"	P120	8,000	10
051144-80799-4	3" x 1-3/4" x 1/4"	P180	8,000	10

## Scotch-Brite™ CPD5-R and CPD5-S Discs

- Five discs made of a durable web, ganged together on a shaft
- Use for satin or antique finishing as well as light- to medium-duty cleaning applications
- Available on a 1/4" shaft (CPD5-S) or 3M™ Roloc™+ attachment system (CPD5-R)



UPC	Dia x W x (Shaft)	Grade	Max RPM	Qty/Case
<b>CPD5-S</b>				
048011-14593-8	3" x 1-1/4" x 1/4"	A MED	10,000	10
048011-14779-6	4" x 1-1/4" x 1/4"	A MED	8,000	10
<b>CPD5-R</b>				
048011-14594-5	3" x 1-1/4"	A MED	10,000	10
048011-14590-7	4" x 1-1/4"	A MED	8,000	10

## Scotch-Brite™ Specialty Abrasives

### Scotch-Brite™ Clean and Strip XT Pro Discs, Shaft Mount

- Quickly removes rust, paint, mill scale and coatings from metal
- High-strength fiber resists chunking and performs well on edges
- High conformability provides a larger contact patch for faster removal rates
- Silicon carbide mineral cuts aggressively and leaves a fine finish



UPC	Dia x AH	Grade	Max RPM	Qty/Case
061500-30349-2	4" x 1/2" x 1/4"	S XCS	12,000	10
061500-30350-0	4" x 1" x 1/4"	S XCS	12,000	10



### Scotch-Brite™ Clean and Strip XT Pro Extra Cut Discs, Shaft Mount

- Quickly removes heavy rust, thick paint, corrosion and cleans welds
- Aluminum oxide mineral aggressively removes top layer and cleans to the bare metal underneath
- High conformability provides a larger contact patch for faster removal rates
- High-strength fiber resists chunking and performs well on edges



UPC	Dia x AH	Grade	Max RPM	Qty/Case
061500-30351-8	4" x 1/2" x 1/4"	A XCS	12,000	10
061500-30352-6	4" x 1" x 1/4"	A XCS	12,000	10

### Scotch-Brite™ Stars

- Perfect for polishing internal diameters of pipe and tubing
- Conformable Scotch-Brite™ construction assures complete cleaning and polishing of all surfaces



UPC	Diameter	Grade	Max RPM	Qty/Case
048011-13370-6	1-1/2"	A CRS	24,000	100
048011-13800-8	1-1/2"	A VFN	24,000	100
048011-13371-3	2"	A CRS	24,000	100
048011-13803-9	2"	A VFN	24,000	100
048011-13372-0	3"	A CRS	18,000	50
048011-13802-2	3"	A VFN	18,000	50
048011-13373-7	4"	A CRS	18,000	50
048011-13804-6	4"	A VFN	18,000	50

### Scotch-Brite™ Cross Buffs

- Versatile and flexible shape ideal for light deburring, cleaning, finishing and polishing internal diameters and hard to reach areas
- Available in A VFN for high luster finishes or A MED for more aggressive applications requiring increased durability



UPC	Diameter	Grade	Max RPM	Qty/Case
048011-64299-4	1" x 3/8" x 2 PLY x 8-32	A MED	20,000	50
048011-64446-2	1" x 3/8" x 2 PLY x 8-32	A VFN	20,000	50
048011-64305-2	1-1/2" x 3/8" x 2 PLY x 8-32	A MED	20,000	50
048011-64526-1	1-1/2" x 3/8" x 2 PLY x 8-32	A VFN	20,000	50
048011-64447-9	1-1/2" x 1/2" x 2 PLY x 8-32	A VFN	20,000	100
048011-64312-0	2" x 1/2" x 2 PLY x 8-32	A MED	12,000	25
048011-64433-2	2" x 1/2" x 2 PLY x 8-32	A VFN	12,000	25

### Scotch-Brite™ Unitized Wheel Pack 990S

- Contains several Scotch-Brite™ external Unitized Wheels 1" x 1" x 3/16" and 3" x 1/4" x 3/8" in a variety of densities and grades
- Also includes 936 and 990 mandrels



UPC	Size	Min/Case
048011-18245-2	1" x 1" x 3/16" and 3" x 1/4" x 3/8"	1/5

# 3M™ Power Tools: Specialty Abrasives

## 3M™ Die Grinders: 0.3 HP (224W)

- Ideal for light-duty applications such as deburring, blending, finishing and polishing in intricate and hard-to-reach areas
- Exclusive 3M™ Gripping Material reduces vibration and provides a more secure grip



UPC	Model	Max RPM	Noise Level dBA (power)	Weight Pound (kg)	Length Inch (mm)	Height Inch (mm)	Air Inlet Thread	Air Flow Rate SCFM (LPM)	Collet Size
051141-28630-3	28630	25,000	86 (98)	1.4 (0.6)	10 (248)	1 (35)	1/4" NPT	17 (481)	1/4"†
051141-28629-7	28629	25,000	78 (90)	0.9 (0.4)	6 (152)	1 (35)	1/4" NPT	17 (481)	1/4"†
051141-28628-0	28628	18,000	80 (92)	1.5 (0.7)	11 (267)	1 (35)	1/4" NPT	17 (481)	1/4"†
051141-28627-3	28627	18,000	79 (91)	1.2 (0.5)	7 (184)	1 (35)	1/4" NPT	17 (481)	1/4"†

†Includes 1/8" collet insert (PN55772)

## 3M™ Die Grinders: 0.5 HP (372W)

- Ideal for medium-duty applications such as polishing, buffing, shaping and deburring
- Exclusive 3M™ Gripping Material reduces vibration and provides a more secure grip



UPC	Model	Max RPM	Noise Level dBA (power)	Weight Pound (kg)	Length Inch (mm)	Height Inch (mm)	Air Inlet Thread	Air Flow Rate SCFM (LPM)	Collet Size
051141-28330-2	28330	18,000	87 (99)	1.1 (0.5)	7 (175)	3 (70)	1/4" NPT	26 (736)	1/4"
051141-28331-9	28331	18,000*	87 (99)	1.5 (0.7)	11 (270)	3 (70)	1/4" NPT	26 (736)	1/4"
051141-28332-6	28332	4,000	87 (99)	1.6 (0.7)	9 (200)	3 (70)	1/4" NPT	26 (736)	1/4"

\*With extension

## 3M™ Die Grinders: 1 HP (744W)

- Excellent for big jobs such as weld or stock removal
- Exclusive 3M™ Gripping Material reduces vibration and provides a more secure grip



UPC	Model	Max RPM	Noise Level dBA (power)	Weight Pound (kg)	Length Inch (mm)	Height Inch (mm)	Air Inlet Thread	Air Flow Rate SCFM (LPM)	Collet Size
051141-20237-2	20237	20,000	86 (98)	2.0 (0.9)	8 (197)	3 (73)	3/8" NPT	37 (1,048)	1/4"
051141-20238-9	20238	18,000	89 (101)	2.0 (0.9)	8 (197)	3 (73)	3/8" NPT	37 (1,048)	1/4"
051141-28770-6	28770	18,000	84 (95)	3.0 (1.4)	13 (318)	3 (73)	3/8" NPT	37 (1,048)	1/4"
051141-20239-6	20239	12,000	N/A	2.6 (1.2)	10 (254)	3 (81)	3/8" NPT	37 (1,048)	1/4"
051141-20240-2	20240	8,000	N/A	2.6 (1.2)	10 (254)	3 (81)	3/8" NPT	37 (1,048)	1/4"

\*Available in metric collet

### Collet Insert Availability for 3M™ Die Grinders



Tool Model	HP	RPM	Length	Collet Insert Size and Part Number									
				1/8" (06573)	1/8" (55772)	3/16" (06574)	1/4" (06575)	1/4" (55752)	3/8" (06545)	3 mm (06576)	6 mm (06577)	8 mm (06546)	
28630	0.3	25,000	Extended		●			●					
28629	0.3	25,000	Regular		●			●					
28628	0.3	18,000	Extended		●			●					
28627	0.3	18,000	Regular		●			●					
28330	0.5	18,000	Regular	●		●	●		●	●	●	●	
28331	0.5	18,000	Extended		●			●					
28332	0.5	4,000	Regular	●		●	●		●	●	●	●	
20237	1	20,000	Regular	●		●	●		●	●	●	●	
20238	1	18,000	Regular	●		●	●		●	●	●	●	
28770	1	18,000	Extended	●		●	●		●	●	●	●	
20239	1	12,000	Regular	●		●	●		●	●	●	●	
20240	1	8,000	Regular	●		●	●		●	●	●	●	

## 3M™ Power Tools: Specialty Abrasives

### 3M™ Match and Finish Sander: 1 HP (744W)







- Generate straight-line scratches for finishing stainless steel and other metals
- Front to back motion helps prevent curved scratches
- Easy to control for reduced start/stop marks
- Easy screw-on/screw-off attachments
- Design for use with Scotch-Brite™ Match and Finish Flap Brushes, 3M™ Abrasive Belts or Scotch-Brite™ Belts\*

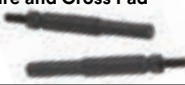

UPC	Model	Shaft Size	Max RPM	Weight Pound (kg)	Length Inch (mm)	Air Inlet Thread	Airflow Rate SCFM (LPM)
051141-28659-4	28659	4" x 5/8-11 EXT	3,500	4.6 (2.1)	13.5 (343)	1/4" NPT	37 (1,048)

\*To run belt products, 3M™ Expander Wheel (28718) and Adapter Kit (28719) are required

## Accessories: Specialty Abrasives

Product	UPC	For Use With	Size/Description	Max RPM	Qty/Case
<b>Mandrel 944</b> 	048011-13928-9	Scotch-Brite™ Stars for cleaning and polishing internal diameters of pipe and tubing	1/4" x 1/4-20 EXT	25,100	1
<b>3M™ Mandrels</b> 	051144-45119-7	Screw-type mandrels for securing cartridge rolls to tool	1/8" x 1" x 1/4"	24,000 (1/2" and smaller cartridge roll diameter); 16,000 (5/8" - 3/4" cartridge roll diameter)	25
	051144-45117-3	Screw-type mandrels for securing cartridge rolls to tool	3/16" x 1" x 1/4"		25
	051144-45118-0	Screw-type mandrels for securing cartridge rolls to tool	3/16" x 1-1/2" x 1/4"		25
<b>3M™ Square and Cross Pad Mandrel</b> 	051144-14308-5	Used for holding square and cross pads with 1/4-20 and 8-32 internal threaded inserts	1/4" x 1/4-20 EXT	Dependent upon abrasive product used	1
	051144-14307-8		1/4" x 8-32 EXT		1
	051141-28385-2		1/4" x 3-48 EXT		5
<b>Forked Spindle</b> 	051144-45121-0	For attaching utility cloth strips	3" x 1/16" x 3/4" x 1/4"	N/A	10
<b>For 3M™ Match and Finish Sander</b>					
<b>3M™ Rubber Slotted Expander Wheel</b> 	051141-28718-8	Rubber Slotted Expander Wheel for use with 3-1/2" x 15-1/2" belts	5" x 3-1/2" x 1" AH	3,500	1
<b>3M™ Rubber Slotted Expander Adapter Kit</b> 	051141-28719-5	Inline sander, bench grinders, bench motors, benchtop tools	1" x 5/8-11 INT	3,500	1



# Adhesives and Tapes

## Adhesives Selection Guide

Metal to:	Structural Adhesives: Each adhesive has high cohesive strength to bond high strength materials and potentially replace mechanical fasteners		Solvent and Water Based Spray Adhesives	
	3M™ Scotch-Weld™ Epoxy, Acrylic Adhesives	3M™ Scotch-Weld™ Instant Adhesives	3M™ Solvent and Water Based Adhesives	3M™ Aerosol Adhesives
<b>Metal</b>	Acrylics, Epoxies	CA40H	1357, 1099 (All), 1300	80, 90
<b>EPDM Rubber</b>	—	CA40H	4799	—
<b>Rubber (except EPDM)</b>	Flexible 2-part Epoxies	CA40H	1300, 847	80, 90*
<b>Glass and Ceramics</b>	Flexible 2-part Epoxies	—	1357	80, 90
<b>Leather</b>	Flexible 2-part Epoxies	—	847	80
<b>Plastics (Polyolefins)</b>	DP8005	—	—	90
<b>Plastics (ABS, PVC, Acrylic, etc.)</b>	DP8005	CA40H	1357	77, 80, 90
<b>Plastics (High Performance Nylon)</b>	DP460	CA40H	1099 (All)	77, 80, 90
<b>Plastics (Flexible Vinyl)</b>	Flexible 2-part Epoxies	CA40H	1099 (All)	80
<b>Paper and Cardboard</b>	2-part Epoxies	—	10	77
<b>Fabric, Felt, Cork and Fibrous Glass</b>	2-part Epoxies	—	—	74, 77, 80, 90
<b>Flexible Foam (Latex, Urethane)</b>	—	—	—	74, 90
<b>Rigid Foam (Beadboard, Styrene)</b>	Flexible 2-part Epoxies	—	—	—
<b>Rigid Foam (Urethane)</b>	Flexible 2-part Epoxies	CA40H	1357, 5, 10	74, 80

Note: The technical information and data on these pages should be considered representative or typical only and should not be used for specification purposes. Final product selection should be made only after consideration of a variety of factors and evaluations of sample bonds.

\*Produces a temporary bond on these materials. (1) Adhesives must be force dried and bonded while warm. (2) For best results, preheat the substrate to a minimum of 120°F (49°C). (3) Evaluate usage surface activator.



## 3M™ Aerosol Adhesives

Only a finger's touch puts a job-matched formulation to work on paper, plastic, cardboard, foam, metal and more. 3M Aerosol Adhesives contain no methylene chloride, chlorofluorocarbons (CFCs), or 1,1,1-trichloroethane (methyl chloroform) and are California compliant.

Product	Description	UPC	Spray Width	Bonding Range Surfaces One/Both	(PSI) Shear <sup>1</sup> Initial/Ultimate	Relative Adhesion		Coverage Sq Ft/ Container <sup>4</sup> (Typical)	Color	Size	Qty/ Case
						Peel Strength (PIW) <sup>2</sup>	Temperature Resistant <sup>3</sup>				
<b>3M™ FoamFast 74 Spray Adhesive</b>											
	<ul style="list-style-type: none"> <li>Fast tack with foam-tearing strength</li> <li>Soft, non-dimpling glue line</li> <li>General upholstery foam bonding</li> <li>Knife edge bonding, boxing, edge turning</li> <li>Bonds flexible urethane or latex foam together or to wood, metal and plastic</li> </ul>	021200-82242-1	1"-4" variable	N/R/ 15 min	40/205	20	120°F (49°C)	260	Orange	24 fl oz can	12
		021200-50045-9							Clear	24 fl oz can	12
<b>3M™ Super 77™ Multipurpose Spray Adhesive</b>											
	<ul style="list-style-type: none"> <li>Fast, aggressive tack for bonding many lightweight materials</li> <li>High coverage</li> <li>Low soak-in for long lasting bonds</li> <li>Bonds gaskets in water pumps, and attaches insulation to sheet metal</li> </ul>	021200-96315-5*	1-1/2"–4" fan	15 min/ 30 min	25/160	15	110°F (43°C)	220	Original Formula	24 fl oz can	12
		021200-21210-9							Low Mist	24 fl oz can	12
<b>3M™ Rubber &amp; Vinyl 80 Spray Adhesive</b>											
	<ul style="list-style-type: none"> <li>Neoprene-based contact adhesive with plasticizer resistance</li> <li>Adheres stainless steel panels, stiffeners, metal kick plates, leather and most supported vinyl, plastics, laminates, wood products and rubbers (except EPDM)</li> </ul>	021200-82618-4	3"	N/R/ 1 hr	50/400	35	200°F (93°C)	75/304	—	24 fl oz can	6
<b>3M™ Hi-Strength 90 Spray Adhesive</b>											
	<ul style="list-style-type: none"> <li>High contact bond for decorative laminate</li> <li>Adheres to polyethylene and polypropylene to wood, metal and more</li> <li>One minute dry time</li> </ul>	076308-86235-0	1"-4" variable	N/R/ 15 min	45/230	25	160°F (71°C)	100	—	24 fl oz can	12

1 ATD T.M. C-700: 1/8" birch veneer bonded to 1/8" birch veneer

2 ATD T.M. C-449

3 ATD T.M. C-483: 500 g load for 1 hour at noted temperature

4 Plastic laminate bonding @ 3-5 g/sq ft coverage

5 Coverage based on container sizes 24 fluid ounce or 16 fluid ounce size cans

N/R = Not Recommended







\*Not for sale in California

**Note:** The technical information and data on these pages should be considered representative or typical only and should not be used for specification purposes.

# 3M™ Plastic Adhesives

## Rubber, Gasket and Industrial Adhesives.

These Adhesives are designed to provide solutions for a wide variety of applications.



Product	Description/UPC	Solids Weight (Approx)	Flash Point (Closed Cup)	Consistency	Color Dry Film	Application Method	Bonding Range	Overlap Shear Strength (PSI)		Peel Strength (PSI)	Size	Qty/Case
								75°F (24°C)	180°F (82°C)	75°F (24°C)		
<b>3M™ Nitrile High Performance Plastic Adhesive 1099</b>												
	<ul style="list-style-type: none"> <li>Fast drying and heat curable</li> <li>Resists weathering, water, oil, plasticizer migration, aliphatic fuels</li> <li>A very strong plastic adhesive</li> <li>Bonds most plastic and vinyl</li> </ul>											
	021200-19808-3	32%	0°F (-18°C)	Medium Liquid	Light Tan	Brush, Flow	Up to 40 min	1,306*	643*	313	5 oz tube	36
<b>3M™ Nitrile High Performance Plastic Adhesive 1099L</b>												
	<ul style="list-style-type: none"> <li>Lower viscosity</li> <li>Sprayable version of 1099 Adhesive</li> </ul>											
	021200-22578-9	24%	0°F (-18°C)	Thin Liquid	Tan	Spray, Brush	Up to 20 min	1,306*	643*	313	5 gal pail	1
<b>3M™ Nitrile High Performance Industrial Plastic Adhesive 4693H</b>												
	<ul style="list-style-type: none"> <li>Clear, elastomeric adhesive</li> <li>Exceptional adhesion to metal and plastic</li> <li>Unique in its ability to bond hard-to-hold materials like polypropylene, polyethylene and high impact polystyrene</li> </ul>											
	021200-30088-2	36%	1°F (-17°C)	Medium Liquid	Clear	Flow, Brush	Up to 60 min	—	—	223	5 oz tube	36
<b>3M™ Nitrile High Performance Rubber and Gasket Adhesive 847</b>												
	<ul style="list-style-type: none"> <li>Quick drying and flexible with fuel and oil resistance</li> <li>Heat and solvent reactivatable</li> <li>Curable with heat</li> </ul>											
	021200-19718-5	36%	0°F (-18°C)	Medium Liquid	Brown	Flow, Brush	Up to 15 min	2,004	94	403	5 oz tube	36
	021200-19721-5										1 qt.	12
<b>3M™ Neoprene High Performance Rubber and Gasket Adhesive 1300</b>												
	<ul style="list-style-type: none"> <li>High immediate strength</li> <li>Fast-drying and heat resistant for rubber and metal</li> </ul>											
	021200-19868-7	37%	-14°F (-26°C)	Medium Liquid	Yellow	Flow, Brush	Up to 12 min	5,491	1,364	523	5 oz tube	36
<b>3M™ Industrial Adhesive 4799</b>												
	<ul style="list-style-type: none"> <li>Brushable paste consistency with low soak-in on porous surfaces</li> <li>Can bond EPDM rubber</li> </ul>											
	021200-21354-0	36%	-14°F (-26°C)	Thin Paste	Black	Brush, Trowel	Up to 15 min	—	—	283	5 oz tube	36

\*After supplemental heat cure, see TDS.

Note: The technical information and data on these pages should be considered representative or typical only and should not be used for specification purposes.

## 3M™ Neoprene Contact Adhesives

This line offers a wide range of choices for contact adhesives applications. Select from bonding ranges, strengths, solids contents and solvent formulations to meet requirements for bonding laminate, foam and more.

Product	Description/UPC	Solids Weight (Approx)	Flash Point (Closed Cup)	Consistency	Color Dry Film	Application Method	Bonding Range	Overlap Shear Strength (PSI)		Peel Strength (PSI)	Color	Size	Qty/Case	
								75°F (24°C)	180°F (82°C)	75°F (24°C)				
<b>3M™ Neoprene Contact Adhesive 5</b>														
	<ul style="list-style-type: none"> <li>• Rapid strength buildup</li> <li>• Heat and creep resistant bond</li> <li>• Bonds many high pressure plastic laminates to metal and other surfaces</li> </ul>													
	021200-21232-1	19%	-14°F (-26°C)	Thin Liquid	Green	Spray	30 min max	482 <sup>1</sup>	65 <sup>1</sup>	19 <sup>2</sup>	Green	5 Gal Pail	1	
	021200-20333-6				Light Yellow						Light Yellow	5 Gal Pail	1	
<b>3M™ Neoprene Contact Adhesive 10</b>														
	<ul style="list-style-type: none"> <li>• Similar performance to Contact Adhesive 5</li> <li>• Brushable with higher coverage</li> <li>• Bonds aluminum, steel, rubber and other porous and non-porous materials to each other or to themselves</li> </ul>													
	021200-20272-8	22%	-14°F (-26°C)	Thin Liquid	Light Yellow	Brush, Roller	30 min max	482 <sup>1</sup>	65 <sup>1</sup>	19 <sup>2</sup>	Light Yellow	1 Quart	12	
	021200-20274-2											1 Gal	4	
	021200-20276-6											5 Gal Pail	1	
<b>3M™ Neoprene High Performance Contact Adhesive 1357</b>														
	<ul style="list-style-type: none"> <li>• Rapid buildup to a very high strength bond for metal</li> <li>• Resists heat and continuous load stress</li> <li>• Adheres well to metal, rubber, wood and glass</li> </ul>													
	021200-19887-8	25%	-14°F (-26°C)	Thin Liquid	Gray-green, Light Yellow	Brush, Spray	30 min max	536 <sup>1</sup>	199 <sup>1</sup>	42 <sup>2</sup>	Gray Green	5 oz tube	36	
	021200-19890-8											1 Pint	12	
	021200-19892-2											1 Quart	12	
	021200-19894-6											1 Gal	4	
	021200-19897-7											5 Gal Pail	1	
	021200-22586-4											Light Yellow	1 Gal	4
	021200-64963-9											Light Yellow	5 Gal Pail	1





1 Birch plywood to birch plywood @ 0.1 inches/minute separation rate

2 Canvas to cold rolled steel @ 2.0 inches/minute separation rate

**Note:** The technical information and data on these pages should be considered representative or typical only and should not be used for specification purposes.

## 3M™ Sealants





Help keep air, dirt, fuel, cold, heat or other elements in or out, you'll find formulations from acrylic to polyurethane.

Product	Description/UPC	Solids Weight (Approx)	Flash Point (Closed Cup)	Consistency	Color (Dry)	Application Method	Cure or Dry Time	Service Temperature Range	Size	Qty/Case
<b>3M™ Polyurethane Sealant 540</b>										
										
	<ul style="list-style-type: none"> <li>• Polyurethane</li> <li>• One-component</li> <li>• Moisture cures rapidly to flexible seal/bond for many plastics, metal, wood and more</li> <li>• 250 psi tensile strength</li> </ul>									
	021200-41594-4	90%	136°F (58°C)	Paste	Gray	Hand or Pressure Caulk	24 hours (1/8" Dia bead)	-40° to 194°F (-40° to 90°C)	10.5 oz cartridge	12
	068060-47198-7								400mL sausage pack	12
<b>3M™ Polyurethane Adhesive Sealant 560</b>										
										
	<ul style="list-style-type: none"> <li>• Similar to 540 but with 580 psi tensile strength</li> <li>• May replace mechanical fasteners</li> <li>• Polyurethane</li> <li>• One-component</li> <li>• Moisture cures rapidly to flexible seal/bond for many plastics, metal, wood and more</li> </ul>									
	021200-41596-8	90%	136°F (58°C)	Paste	Gray	Hand or Pressure Caulk	24 hours (1/8" Dia bead)	-40° to 194°F (-40° to 90°C)	10.1 fl oz cartridge	12
<b>3M™ Scotch-Seal™ Tamper Proof Sealant 1252</b>										
										
	<ul style="list-style-type: none"> <li>• Fire retardant seal</li> <li>• Resists oil, gasoline, water, jet fuel and fungus</li> <li>• Will not corrode metal</li> <li>• Tack-free in 20 seconds</li> </ul>									
	021200-20193-6	70%	20°F (-7°C)	Thin Paste	White	Pressure-Flow Gun	24 hours (1/8" Dia bead)	-20° to 250°F (-29° to 121°C)	5 oz tube	36
<b>3M™ Scotch-Seal™ Metal Sealant 2084</b>										
										
	<ul style="list-style-type: none"> <li>• Seals metal to glass in windows and doors</li> <li>• Resists weather, water, oil and gasoline</li> </ul>									
	021200-20227-8	46%	0°F (-18°C)	Heavy Liquid	Silver	Brush or Flow	24 hours (1/8" Dia bead)	-30° to 250°F (-34° to 121°C)	5 oz tube	36

Note: The technical information and data on these pages should be considered representative or typical only and should not be used for specification purposes.

## 3M™ Scotch-Weld™ Epoxy and Acrylic Adhesives

Used as an alternative for mechanical or fusion fastening due to its greater design latitude, cleaner lines, lighter weight, greater durability, less machining and often less cost.

Product/Color <sup>1</sup>	Description/UPC	Mix Ratio (Vol) B:A	Approx <sup>2</sup> Viscosity 75°F (24°C) (CPS)	Approx <sup>3</sup> Worklife at 75°F (24°C)	Floating Roller Peel at 75°F (24°C)	Overlap Shear Strength <sup>5</sup> (PSI)			Size	Qty/Case
						-20°F (-29°C)	75°F (24°C)	180°F (82°C)		
<b>3M™ Scotch-Weld™ Epoxy Adhesive DP100 Clear</b>										
	<ul style="list-style-type: none"> <li>Fast cure rigid epoxy</li> <li>15–20 minute handling strength</li> <li>Transparent when cured</li> </ul>									
	638060-08994-1	1:1	13,000	5 min	2	900	1,500	300	48.5mL	12
<b>3M™ Scotch-Weld™ Epoxy Adhesive DP100 Plus</b>										
	<ul style="list-style-type: none"> <li>Very flexible adhesive</li> <li>Fast 4 minute work life with handling strength in 20 minutes at room temperature</li> <li>Good high shear and peel strength</li> </ul>									
	638060-08976-7	1:1	8,500	4 min	55	3,000	3,500	200	48.5mL	12
<b>3M™ Scotch-Weld™ Epoxy Adhesive DP420 Black</b>										
	<ul style="list-style-type: none"> <li>Medium worklife, toughened epoxy</li> <li>1–2 hours handling strength</li> <li>Tough, durable structural bonds</li> <li>Very high performance, two-part epoxy adhesive</li> <li>Great for bonding metal, plastic and wood</li> </ul>									
	638060-08978-1	2:1	30,000	20 min	75	4,500	4,500	1,250	50mL	12
<b>3M™ Scotch-Weld™ Epoxy Adhesive 2216 B/A Gray</b>										
	<ul style="list-style-type: none"> <li>Long worklife flexible epoxy</li> <li>8–12 hours handling strength</li> <li>Bonds plastic, metal and other dissimilar materials</li> </ul>									
	021200-20356-5	2:3	80,000	90 min	50	3,000	3,200	400	Quart Kit	6
<b>3M™ Scotch-Weld™ Epoxy Adhesive DP460 Off-White</b>										
	<ul style="list-style-type: none"> <li>Long worklife toughened epoxy</li> <li>2–4 hours handling strength</li> <li>Very high performance epoxy adhesive</li> <li>Great for bonding a wide variety of materials with outstanding reliability and durability</li> </ul>									
	638060-08998-9	2:1	30,000	60 min	80	4,500	4,500	700	50mL	12

1 Color is mixed if two-part product

2 Brookfield viscometer viscosity values are typical values for the mixed product







3 The time during which an adhesive will adequately wet-out on a substrate

4 80° peel tested on .030" aluminum per ASTM D 1876-61T

5 Tested per ASTM D 1002-64

Note: The technical information and data on these pages should be considered representative or typical only and should not be used for specification purposes.

# 3M™ Scotch-Weld™ Epoxy and Acrylic Adhesives

Product/Color <sup>1</sup>	Description/UPC	Mix Ratio (Vol) B:A	Approx <sup>2</sup> Viscosity at 75°F (24°C) (CPS)	Approx <sup>3</sup> Worklife at 75°F (24°C)	Floating Roller Peel at 75°F (24°C)	Overlap Shear Strength <sup>5</sup> (PSI)			Size	Qty/Case
						-20°F (-29°C)	75°F (24°C)	180°F (82°C)		
<b>3M™ Scotch-Weld™ Low Odor Acrylic Adhesive DP810</b>										
	<ul style="list-style-type: none"> <li>Acrylic bonds many metals and plastics without surface prep</li> <li>Fast strength buildup</li> <li>Fully cured in 8 hours</li> <li>Low odor</li> <li>High peel and shear strength on slightly oily steel, aluminum, glass and painted surfaces</li> </ul>									
	638060-08967-5 (Black)	1:1	20,000	10 min	30	1,200	3,600	500	48.5mL	12
	638060-08986-6 (Tan)									12
<b>3M™ Scotch-Weld™ Low Odor Acrylic Adhesive DP810NS Tan</b>										
	<ul style="list-style-type: none"> <li>Non-sag version of DP810</li> <li>10-15 minute handling strength</li> </ul>									
	021200-49082-8	1:1	95,000	10 min	20	1,200	4,000	500	48.5mL	12
<b>3M™ Scotch-Weld™ Structural Plastic Adhesive DP8005</b>										
	<ul style="list-style-type: none"> <li>2-part acrylic adhesive bonds to polyethylene and polypropylene with no surface preparation</li> <li>Tough bond strength to resist vibration and impact</li> <li>Bonds most difficult-to-bond LSE (low surface energy) plastics</li> </ul>									
	051128-99349-1 (Off-White)	10:1	25,000	3 min	N/A	750	2,200	500	45mL	12
	051128-99352-1 (Black)					875	2,000	475		12
<b>3M™ Scotch-Weld™ Low Odor Acrylic Adhesive DP8810NS Green</b>										
	<ul style="list-style-type: none"> <li>10 minute work life</li> <li>Low odor</li> <li>Fast rate of strength build up</li> </ul>									
	051128-99432-0	10:1	80,000	10 min	30 min	900	3,600	800	45mL	12
	051128-99431-3								490mL	6
<b>3M™ Scotch-Weld™ Low Odor Acrylic Adhesive DP8805NS Green</b>										
	<ul style="list-style-type: none"> <li>5 minute work life</li> <li>Low odor</li> <li>Fast rate of strength build-up</li> </ul>									
	076308-98433-5	10:1	80,000	5 min	30 min	800	3,600	900	45mL	12
	076308-98439-7								490mL	6
<b>3M™ Scotch-Weld™ Acrylic Adhesive DP8405NS Green</b>										
	<ul style="list-style-type: none"> <li>5 minute work life</li> <li>High impact resistance</li> <li>Minimal surface prep</li> </ul>									
	051115-68963-5	10:1	70,000	5 min	50 min	2,600	4,100	900	45mL	12
	051115-68964-2								490mL	6
<b>3M™ Scotch-Weld™ Metal Bonder Acrylic Adhesive DP8407NS</b>										
	<ul style="list-style-type: none"> <li>7 minute work life</li> <li>Withstands powder coat and paint bake cycles</li> <li>High shear, peel and impact strength</li> </ul>									
	638060-14631-6	10:1	20,000	7 min	50 min	3,400	4,500	1,400	45mL	12
	638060-14643-9								490mL	6

1 Color is mixed if two-part product  
 2 Brookfield viscometer viscosity values are typical values for the mixed product  
 3 The time during which an adhesive will adequately wet-out on a substrate  
 4 80° peel tested on .030" aluminum per ASTM D 1876-61T  
 5 Tested per ASTM D 1002-64

**Note: The technical information and data on these pages should be considered representative or typical only and should not be used for specification purposes.**







# 3M™ Scotch-Weld™ Anaerobic Adhesives

Description	UPC	Product	Typical Use	Color	Typical Viscosity (CPS)	Temp Range (°F)	Time to Handling (sec)	Full Cure (hrs)	Bottle Size	Qty/Case
-------------	-----	---------	-------------	-------	-------------------------	-----------------	------------------------	-----------------	-------------	----------

### 3M™ Scotch-Weld™ Threadlockers

- Prevent vibration loosening
- Seal against leakage and corrosion
- Replaces wide variety of traditional and sometimes ineffective vibration proofing methods, reducing cost and increasing performance

	048011-62601-7	TL22	Screwlock — Low removal torque for small fasteners less than 1/4" (6mm) (Hand tool for removal)	Purple	1,200	-65° to 300°	<20	24	10mL	10
	048011-62603-1								250mL	2
	048011-62602-4								50mL	10
	048011-62604-8	TL42	Nutlock — Medium strength, general purpose (Hand tool for removal)	Blue	1,200	-65° to 300°	<20	24	10mL	10
	048011-62605-5								1L	10
	048011-62607-9								250mL	2
	048011-62606-2								50mL	10
	051115-25137-5	TL72	High temperature studlock with gap filling for larger diameter coarse threaded parts (Heat and hand tool for removal)	Red	7,000	-65° to 300°	<20	24	50mL	10
	048011-62615-4	TL90	Penetrating adhesive for pre-assembled fastener and porosity sealing of welds (Heat and hand tool for removal)	Green	20	-65° to 300°	<20	24	1mL	10
	048011-62617-8								250mL	2
	048011-62616-1								50mL	10

### 3M™ Scotch-Weld™ Retaining Compounds

- Used in the assembly of coaxial components such as bearings, gears, shafts, bushes, pulleys, cylinder liners and rotors
- Increases load bearing characteristics of cylindrical joints, reducing assembly stresses, assembly costs and preventing fretting and corrosion

	048011-62661-1	RT09	General Purpose: For tight tolerances and press fit augmentation	Green	125	-65° to 300°	10–30	24	10mL	10
	048011-62663-5								250mL	2
	048011-62662-8								50mL	10

Product	Description/UPC	Product	Color	Typical Viscosity (CPS)	Temp Range (°F)	Cured Speed Unprimed (Primed)	Cured State	Size	Qty/Case
---------	-----------------	---------	-------	-------------------------	-----------------	-------------------------------	-------------	------	----------

### 3M™ Scotch-Weld™ Gasket Makers

- Creates formed-in-place gaskets on flanges and housing to eliminate the need for large inventories of pre-cut gaskets
- Will not relax or shrink
- Exceptional pressure and solvent resistance

	048011-62660-4	GM18	Red	Paste	-65° to 300°	4–24 hours (30 min–4 hours)	Flexible	300gm cart	10
	048011-62658-1							50mL tube	10

Product	Description/UPC	Product	Color	Size	Qty/Case
---------	-----------------	---------	-------	------	----------

### 3M™ Scotch-Weld™ Anaerobic Activator

- Acetone-based primer for inactive or very cold surfaces
- 30 day part life for pre-application

	048011-62708-3	AC649	Green	2 fl oz bottle	10
	048011-62709-0			8 fl oz bottle	4

Note: The technical information and data on these pages should be considered representative or typical only and should not be used for specification purposes.

## 3M™ VHB™ Tapes

3M™ VHB™ Tapes are high-strength bonding tapes and a proven alternative to screws, rivets, welds and other mechanical fasteners. Unlike screws or rivets — which join materials at a single point — high-strength bonding tape permanently adheres one substrate to another while spreading the stress load across the entire length of the joint. Once materials are joined with 3M™ VHB™ Tape a virtually indestructible “weld” is created.

3M™ VHB™ Tape’s all-acrylic construction seals against moisture and most solvents, providing long-term resistance to UV and temperature cycles. The tape’s unique foam acts as a shock absorber for outstanding impact resistance. Unlike the stress points common to mechanical fasteners, 3M™ VHB™ Tapes distribute the stress. You can use thinner, light-weight materials with less material fatigue.

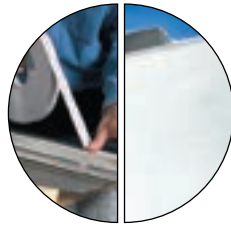

3M™ VHB™ Tapes

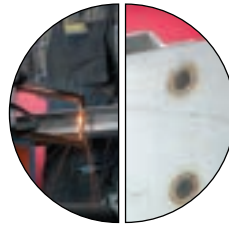



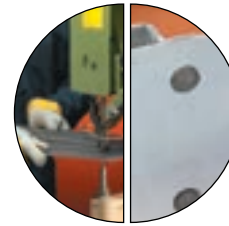

Welds



Rivets

## High-Strength Bonding Tapes

Product	UPC	Product	Typical Use	Color	Thickness	Temperature Resistance		Size	Qty/Case
						Short	Long		
<b>3M™ VHB™ Tapes</b>									
	021200-64886-1	4941	<ul style="list-style-type: none"> <li>Conformable and plasticizer resistant</li> <li>Good adhesion to metals, plastics and plasticized vinyls</li> </ul>	Gray	45 mils	300°F (149°C)	200°F (93°C)	1/2" x 36 yds	18
	021200-64887-8							3/4" x 36 yds	12
	021200-64888-5							1" x 36 yds	9
	638060-14299-8	GPH-110	<ul style="list-style-type: none"> <li>3M VHB Tape GPH family's high temperature resistance allows it to be bonded prior to powder coat or liquid painting processes</li> <li>This reduces the number of "touches," leading to a more streamlined manufacturing process</li> </ul>	Gray	45 mils	450°F (232°C)	300°F (149°C)	1/2" x 36 yds	18
	638060-14300-1							3/4" x 36 yds	12
	638060-14301-8							1" x 36 yds	9
	021200-59967-5	5952	<ul style="list-style-type: none"> <li>Bonds to most liquid and powder painted surfaces, and ABS blends, without the need to prime the surface first</li> </ul>	Dark Gray	45 mils	300°F (149°C)	250°F (121°C)	1/2" x 36 yds	18
	021200-56229-7							1" x 36 yds	9
	021200-16961-8	4945	<ul style="list-style-type: none"> <li>Plasticizer resistant</li> <li>High strength firm core</li> <li>Bonds to most painted substrates</li> <li>Good adhesion to substrates containing plasticizers</li> </ul>	White	45 mils	300°F (149°C)	200°F (93°C)	1/2" x 36 yds	18
	021200-16954-0							3/4" x 36 yds	12
	021200-16955-7							1" x 36 yds	9
	021200-18090-3	4950	<ul style="list-style-type: none"> <li>Bonds to most metals and high surface energy substrates</li> </ul>	White	45 mils	300°F (149°C)	200°F (93°C)	1/2" x 36 yds	18
	021200-18091-0							3/4" x 36 yds	12
	021200-18092-7							1" x 36 yds	9

To evaluate how 3M VHB Tapes can be used in your applications, contact your 3M Sales Specialist or call 1-800-362-3550.

Note: The technical information and data on these pages should be considered representative or typical only and should not be used for specification purposes.

# Masking Made Simple

Five 3M™ Industrial Masking Tapes tapes, built on increasing levels of performance and a common goal of helping you finish jobs worth finishing.

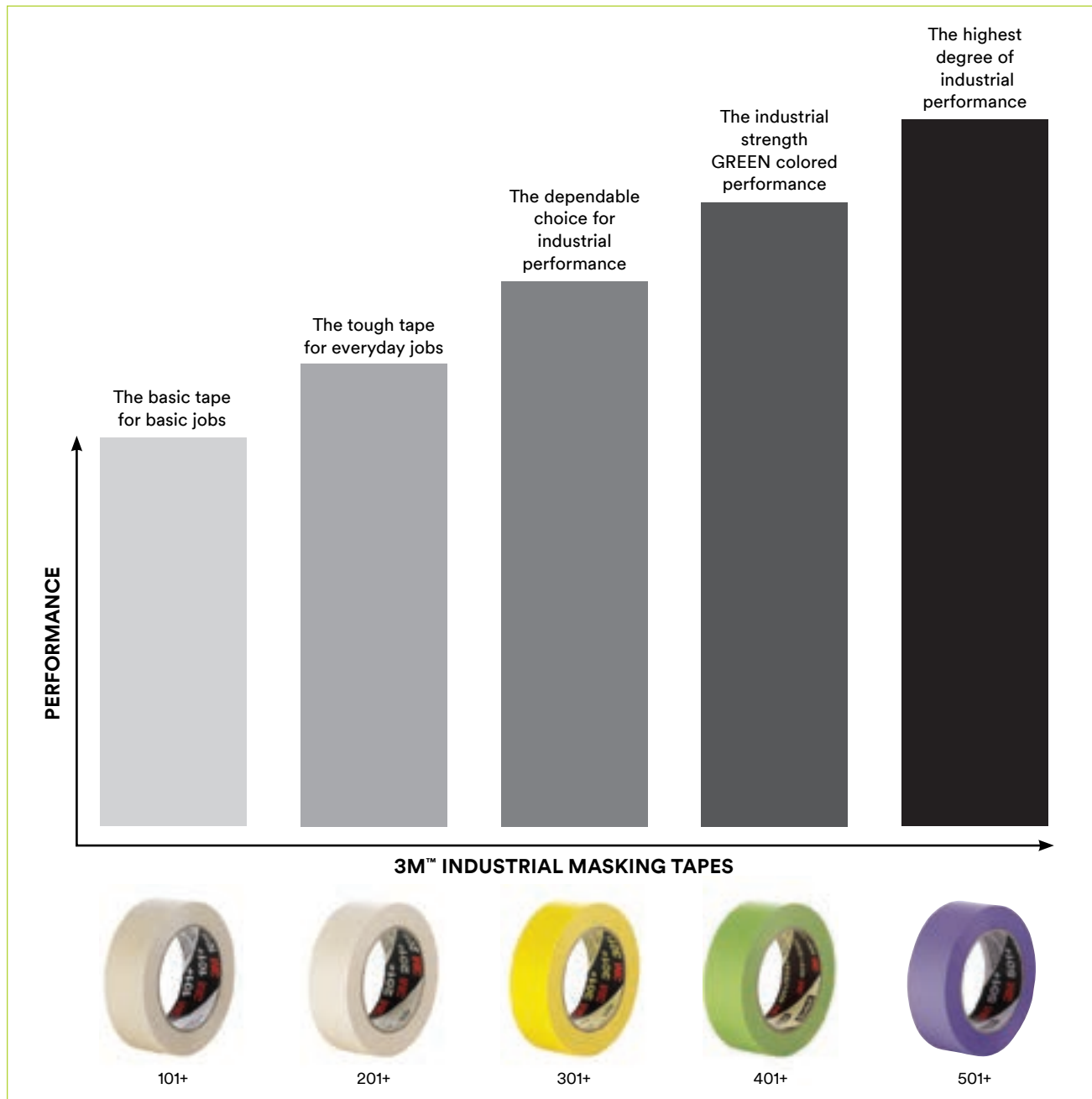

# Industrial Masking Tapes

Product	Description	UPC	Backing/ Adhesive	Total Thickness mils (mm)	Temperature Range °F (°C)	Size	Qty/ Case
<b>3M™ Value Masking Tape 101+</b>							
	<ul style="list-style-type: none"> <li>Indoor use</li> <li>Light-duty applications</li> <li>Ideal for marking, temporary holding, wrapping, and sealing</li> <li>Easy unwind</li> </ul>	051115-68707-5	Crepe Paper/ Rubber	5.1 (0.13)	Up to 150°F (66°C)*	18mm x 55m	48
		051115-68708-2				24mm x 55m	36
		051115-68709-9				36mm x 55m	24
		051115-68710-5				48mm x 55m	24
		051115-67811-2				72mm x 55m	12
<b>3M™ General Use Masking Tape 201+</b>							
	<ul style="list-style-type: none"> <li>Light-to-medium duty</li> <li>Smooth and conformable</li> <li>Sticks with confidence to a wide variety of surfaces</li> <li>Easy to handle, apply and remove in one piece</li> <li>Ideal for bundling, labeling and identifying</li> </ul>	051115-64739-0	Crepe Paper/ Rubber	4.4 (0.11)	Up to 200°F (93°C)*	18mm x 55m	48
		051115-64740-6				24mm x 55m	36
		051115-64741-3				36mm x 55m	24
		051115-64742-0				48mm x 55m	24
		051115-64743-7				72mm x 55m	12
<b>3M™ Performance Yellow Masking Tape 301+</b>							
	<ul style="list-style-type: none"> <li>Good conformability to irregular surfaces</li> <li>Resists paint bleed-through and offers great paint lines</li> <li>Yellow backing ensures good visibility</li> <li>Ideal for industrial paint masking, bundling, holding, marking, color coding and sealing</li> </ul>	051115-64750-5	Smooth Crepe Paper/Rubber	6.3 (0.16)	Up to 225°F (107°C)*	18mm x 55m	48
		051115-64751-2				24mm x 55m	36
		051115-64752-9				36mm x 55m	24
		051115-64753-6				48mm x 55m	24
		051115-64754-3				72mm x 55m	12
<b>3M™ High Performance Green Masking Tape 401+</b>							
	<ul style="list-style-type: none"> <li>Superior adhesion to metal, rubber, glass and plastic, while removing cleanly in one piece with no adhesive residue</li> <li>High conformable to many surfaces</li> <li>Resists paint bleed-through and creates sharp paint lines</li> <li>Green backing improves visibility and accuracy during paint masking</li> <li>Ideal for high performance industrial painting, including two-tone color applications</li> </ul>	051115-64760-4	Smooth Crepe Paper Treated with a Heat Resistant Saturant/ Natural Synthetic Rubber Blend	6.7 (0.17)	Up to 250°F (121°C)*	18mm x 55m	48
		051115-64761-1				24mm x 55m	24
		051115-64762-8				36mm x 55m	16
		051115-64763-5				48mm x 55m	12
		051115-64764-2				72mm x 55m	8
<b>3M™ Specialty High Temperature Purple Masking Tape 501+</b>							
	<ul style="list-style-type: none"> <li>Exceptionally conformable to irregular surfaces</li> <li>Superior adhesion to metal, rubber, glass and plastic</li> <li>Removes cleanly in one piece</li> <li>Extra-strong high-temperature purple crepe paper backing resists bleed-through from most industrial paints</li> <li>Creates super-sharp paint lines</li> <li>Ultra-high strength holding power to prevent paint blow-by on a variety of surfaces</li> </ul>	054596-11630-6	Smooth Crepe Paper Treated with a Heat Resistant Saturant/ Rubber	7.3 (0.185)	Up to 300°F (149°C)*	18mm x 55m	48
		054596-11635-1				24mm x 55m	36
		054596-11637-5				36mm x 55m	24
		054596-11639-9				48mm x 55m	24
		054596-11645-0				72mm x 55m	12

\*Up to 30 minutes

Note: The technical information and data on these pages should be considered representative or typical only and should not be used for specification purposes.

## High-Strength Tapes: Bundling and Reinforcing Solutions

### Scotch® Filament and Strapping Tapes

When you need tough tapes to live up to the challenges of metalworking, 3M high strength tapes are resistant to abrasion, moisture and scuffing for bundling and reinforcing. Applications for these high performance products can vary — from tabbing the end lap of metal coils to stabilizing pallets to reinforcing large bulk containers or just a single carton.

These tapes balance strength and adhesive holding power, even under extreme conditions, providing secure, cost-effective solutions for a variety of strapping, holding, bundling and reinforcing applications.

### Scotch® Filament Tapes Selection Guide

Application	880MSR	890MSR	898MSR	8919MSR	880	894	898	8899HP
<b>Coil Tabbing &amp; Closure</b> <ul style="list-style-type: none"> <li>• Process aid in fabricating and converting large metal sources to smaller metal products</li> <li>• Effectively secure coil for further processing</li> <li>• Impact resistance — coils experience shifting and stacking</li> <li>• Strong holding power — high shear and tensile strength</li> <li>• Nick and scratch resistance — metals are sharp</li> </ul>	•	•	•	•				
<b>Bundling &amp; Strapping</b> <ul style="list-style-type: none"> <li>• Strongest tensile strength products on the market</li> <li>• High abrasion, nick and cut resistance</li> <li>• Adhesion — metal surfaces can have different properties</li> </ul>	•	•			•	•	•	•
<b>Coil Splicing</b> <ul style="list-style-type: none"> <li>• MSR adhesive sticks well to oily surfaces</li> <li>• Increased processing speed</li> <li>• Confidence with high initial adhesion tack to hold the metal</li> </ul>	•	•	•	•				

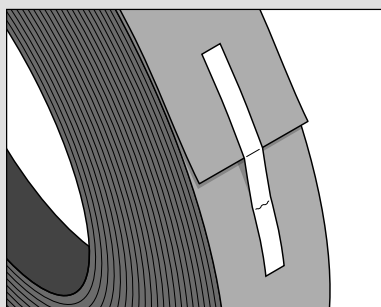

#### Coil Tabbing & Closure

##### Product Value Story:



**Strength**  
High shear, tensile and adhesion strengths



**Cost Saving**  
No waste of metal if tape is used as no damage



**Adhesion**  
Substrates are often oily

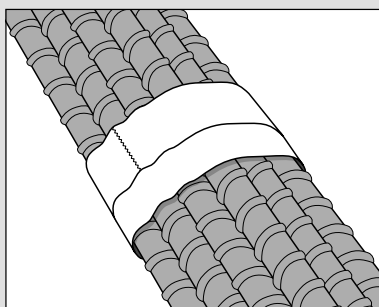

#### Bundling & Strapping

##### Product Value Story:



**Adhesion**  
Substrates are often oily or dusty



**Safety**  
No injury risk, safer to use tape than any indirect competition



**Nick/Scratch Resistance**  
Metals are sharp

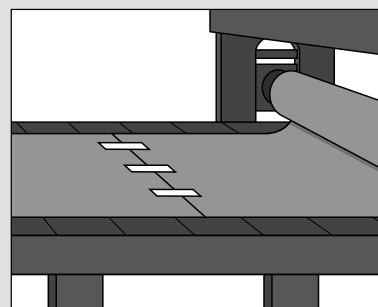

#### Coil Splicing

##### Product Value Story:



**Cost Saving**  
No waste of metal if tape is used as no damage



**Speed**  
No need for additional tools or operators



**Strength**  
Metals are heavy



**Adhesion**  
Adhere to oily surface, no cleaning required

Note: The technical information and data on these pages should be considered representative or typical only and should not be used for specification purposes.

# Scotch® Filament Tapes

Product	Description/UPC	Color	Backing	Reinforcement	Adhesive	Elongation at Break	Tensile Strength (lbs/in)	Size	Qty/Case
<b>Scotch® High Strength Filament Tape 890MSR</b>									
	<ul style="list-style-type: none"> <li>Ideal for heavy gauge metals, metal bundling, coil tabbing, high strength reinforcing, lift flap closure, and heavy duty strapping</li> <li>Specially formulated adhesive to provide optimum oily metal adhesion</li> <li>High adhesion and long term holding power for a variety of demanding metal working applications</li> </ul>								
	051125-74058-6	Clear	Polyester Film	Fiberglass	Modified Synthetic Rubber (MSR)	3%	600	18mm x 55m	48
	051125-74059-3							24mm x 55m	36
	689330-19592-3							48mm x 55m	24
	051125-74063-0	UV-Resistant Black	Polyester Film	Fiberglass	Modified Synthetic Rubber (MSR)	3%	600	18mm x 55m	48
	051125-74064-7							24mm x 55m	36
051125-74061-6	48mm x 55m							24	
<b>Scotch® Filament Tape 880MSR</b>									
	<ul style="list-style-type: none"> <li>Ideal for metal bundling, coil tabbing, high strength reinforcing, lift flap closure, and heavy duty strapping</li> <li>Specially formulated adhesive to provide optimum oily metal adhesion</li> <li>Best cut resistance</li> </ul>								
	051125-74065-4	Clear	Polyester Film	Fiberglass	Modified Synthetic Rubber (MSR)	19%	270	18mm x 55m	48
	051125-74066-1							24mm x 55m	36
	051125-74068-5							48mm x 55m	24
<b>Scotch® Filament Tape 898MSR</b>									
	<ul style="list-style-type: none"> <li>Most versatile tape featuring MSR adhesive</li> <li>Specially formulated adhesive to provide optimum oily metal adhesion</li> <li>Good cut resistance</li> </ul>								
	051125-74069-2	Clear	Polyester Film	Fiberglass	Modified Synthetic Rubber (MSR)	3%	380	18mm x 55m	48
	051125-74080-7							24mm x 55m	36
<b>Scotch® Filament Tape 8919MSR</b>									
	<ul style="list-style-type: none"> <li>Thicker backing for easier dispensing and handling</li> <li>Specially formulated adhesive to provide optimum oily metal adhesion</li> <li>Long term holding power for a variety of demanding metal working applications</li> </ul>								
	051125-74051-7	Clear	Polyester Film	Fiberglass	Modified Synthetic Rubber (MSR)	3%	380	18mm x 55m	48
	051125-74052-4							24mm x 55m	36
	051125-74054-8							48mm x 55m	24
<b>Scotch® Filament Tape 880</b>									
	<ul style="list-style-type: none"> <li>High impact and cut resistance</li> <li>Long term holding power to fiberboard, non-oily metals and printed and painted surfaces</li> </ul>								
	021200-39842-1	Clear	Poly-propylene	Polyester	Synthetic Rubber (SR)	19%	270	12mm x 55m	72
	021200-39844-5							18mm x 55m	48
<b>Scotch® Filament Tape 894</b>									
	<ul style="list-style-type: none"> <li>General purpose packaging tape</li> <li>When used in bundling, reinforcing or coil tabbing applications with high temperatures and/or oily surfaces, tests should be conducted to determine the tape's suitability</li> </ul>								
	021200-88131-2	Black	Poly-propylene	Fiberglass	Synthetic Rubber (SR)	4.5%	300	18mm x 55m	48
<b>Scotch® Filament Tape 898</b>									
	<ul style="list-style-type: none"> <li>Transparent backing provides excellent abrasion, moisture and scuff resistance</li> <li>High tensile strength ensures a tighter hold with less tape</li> <li>Resists breaking or tearing even if nicked or punctured during handling</li> </ul>								
	051131-06897-1	Clear	Poly-propylene	Fiberglass	Synthetic Rubber (SR)	5%	380	18mm x 55m	48
	051131-06898-8							24mm x 55m	36
	021200-39869-8							48mm x 55m	24



Note: The technical information and data on these pages should be considered representative or typical only and should not be used for specification purposes.

# Scotch® Filament Tapes

Product	Description/UPC	Color	Backing	Reinforcement	Adhesive	Elongation at Break	Tensile Strength (lbs/in)	Size	Qty/Case
<b>Scotch® Clean Removal Strapping Tape 8899HP</b>									
	<ul style="list-style-type: none"> <li>Removes cleanly and resists stains on common surfaces, such as painted metal, plastic and glass</li> <li>Proprietary 3M pressure-sensitive rubber adhesive is specifically formulated to adhere evenly and bond firmly to long lasting hold</li> <li>High strength film backing resists breaking, abrasion, moisture and scuffs and includes proper stiffness for manual or semi-automatic dispensing</li> </ul>								
	076308-86417-0	White	Polypropylene	None	Natural Rubber	30%	160	24mm x 55m	36
	076308-98892-0	Blue						18mm x 55m	48
	076308-98893-7							24mm x 55m	36
	076308-98895-1							48mm x 55m	24
<b>Scotch® Bi-Directional Filament Tape 8959</b>									
	<ul style="list-style-type: none"> <li>Bi-directionally fiberglass reinforced tape provides cut and tear resistance</li> <li>Transparency provides clear visibility of box graphics, printing and illustrations</li> <li>Extra security for boxes and bundles</li> </ul>								
	021200-88229-6	Clear	Polypropylene	Bi-Directional Fiberglass	Synthetic Rubber (SR)	6%	150	75mm x 50m	12
	021200-88228-9							50mm x 50m	18
	051128-99456-6							36mm x 55m	24
	021200-88227-2							25mm x 50m	36
021200-88226-5	19mm x 50m							48	
<b>3M™ Polyester Tape 8402</b>									
	<ul style="list-style-type: none"> <li>Film tapes with a silicone adhesive for holding down bagging materials and parts during composite and metal bonding operations</li> <li>Ideal for splicing applications on surfaces that are difficult to adhere to, such as silicone coated papers and films</li> </ul>								
	021200-37750-1	Green	Polyester	Fiberglass	Silicone	125%	25	1/2" x 72 yd	72
	021200-38702-9							3/4" x 72 yd	48
	021200-05687-1							1" x 72 yd	36
	021200-04368-0							2" x 72 yd	24
	021200-05689-5							3" x 72 yd	12
	021200-38715-9							4" x 72 yd	8
	051115-05535-5							12" x 72 yd	4
	051138-94803-0							8" x 72 yd	4
	021200-39135-4							18" x 72 yd	1
<b>3M™ Polyester Tape 8403</b>									
	<ul style="list-style-type: none"> <li>Thicker version of 3M™ Polyester Tape 8402, providing more durability and longer wear</li> </ul>								
	021200-61456-9	Green	Polyester	Fiberglass	Silicone	140%	41	1/2" x 72 yd	72
	021200-61457-6							3/4" x 72 yd	48
	021200-61458-3							1" x 72 yd	36
	021200-61460-6							2" x 72 yd	24
	021200-61459-0							1-1/2" x 72 yd	24
	021200-61461-3							3" x 72 yd	12
	021200-39114-9							2-3/4" x 72 yd	12
	021200-38712-8							6" x 72 yd	8
	021200-38729-6							4" x 72 yd	8
	051138-94754-5							9" x 72 yd	4
	051115-11707-7							36" x 72 yd	1
	021200-30290-9							24" x 72 yd	1
	051115-11858-6							14" x 72 yd	1

Note: The technical information and data on these pages should be considered representative or typical only and should not be used for specification purposes.



## Scotch® Filament Tape Dispensers

Product	UPC	Description	Size	Qty/Case
<b>Scotch® Filament Tape Dispenser H121</b>				
	051111-97744-6	<ul style="list-style-type: none"> <li>• Portable, lightweight, all metal hand-held dispenser</li> <li>• Use for a wide variety of on-the-spot bundling and holding applications</li> <li>• For Scotch® Filament Tapes up to 1" (24mm) wide on a 3" core</li> </ul>	1"	6
<b>Scotch® Box Sealing Tape Dispenser H128</b>				
	021200-06909-3	<ul style="list-style-type: none"> <li>• Durable, heavy-duty metal dispenser</li> <li>• Lightweight steel construction</li> <li>• Adaptable for a variety of on-the-spot bundling and holding applications</li> <li>• Accommodates tapes up to 2" (48mm) wide on a 3" core</li> </ul>	2"	6
<b>Scotch® Definite Length Dispenser M82</b>				
	021200-18959-3	<ul style="list-style-type: none"> <li>• Heavy-duty filament and strapping dispenser</li> <li>• Handles multiple tape rolls simultaneously from 1/2" (12mm) to a maximum combined width of 4" (98mm)</li> <li>• Applications include definite tape lengths for holding, appliance and electronics reinforcing, strapping, or bundling</li> </ul>	4"	1







## 3M™ Specialty Tapes

When you need tapes to withstand the heat and rigors of metal processing, 3M™ Specialty Tapes meet your needs. Whether you need an acid-resistant tape for plating masking, a tape that will come off cleanly after high temperature powder coating, or a tape with thermal conductivity, 3M specialty tapes are there.

These tapes come in a variety of performance backings from glass cloth, aluminum foil, polyester, polyimide, PTFE, vinyls and nylon.

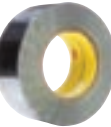
Product	Description/UPC	Product	Color	Backing	Adhesive	Elongation at Break	Tensile Strength (lbs/in)	Size	Qty/Case
<b>3M™ Polyester Tapes 8901/8902/8905</b>									
	<ul style="list-style-type: none"> <li>• Works in demanding conditions and high temperatures ranging from -60°F (-50°C) to 400°F (204°C)</li> <li>• Clean removal during high-temperature masking operations such as powder coating</li> <li>• Polyester film offers excellent thermal and chemical resistance while maintaining flexibility</li> </ul>								
	051111-92767-0	8901	Blue	Polyester	Silicone	115%	26	1" x 72 yds	36
	051111-92769-4							2" x 72 yds	24
	051111-92777-9	8902				1" x 72 yds	36		
	051111-92778-6					2" x 72 yds	24		
	051115-62868-9	8905				1" x 72 yds	36		
051111-92782-3	2" x 72 yds					24			
<b>3M™ Polyester Tape 8991/8992</b>									
	<ul style="list-style-type: none"> <li>• Works in demanding conditions and high temperatures ranging from -60°F (-50°C) to 400°F (204°C)</li> <li>• Clean removal during high-temperature masking operations such as powder coating</li> <li>• Chemical resistance is ideal for anodization processes</li> <li>• Polyester film offers excellent thermal and chemical resistance while maintaining flexibility</li> <li>• Silicone adhesive provides clean removal from a variety of surfaces</li> <li>• Lined versions available</li> </ul>								
	051115-64730-7	8991	Blue	Polyester	Silicone	100%	29	1" x 72 yds	36
	051115-64732-1							2" x 72 yds	24
	051115-64715-4	8992				Green	1" x 72 yds	36	
	051115-64719-2						2" x 72 yds	24	
<b>3M™ Polyimide Tape 8997/8998</b>									
	<ul style="list-style-type: none"> <li>• Ideal for high temperature applications</li> <li>• Seals tight on contact, peels off clean up to 500°F/260°C</li> <li>• High dimensional and tensile strength to break through cured paint</li> <li>• Excellent thermal, chemical and abrasion resistance</li> <li>• Thin backing for sharp paint line</li> <li>• Lined versions available</li> </ul>								
	051128-98857-2	8997	Amber	Polyimide	Silicone	37%	26	1" x 36 yd	36
	051128-98859-6							2" x 36 yd	24
	051128-98866-4	8998				1" x 36 yd	36		
	051128-98868-8					2" x 36 yd	24		



# 3M™ Specialty Tapes

Product	Description/UPC	Product	Color	Backing	Adhesive	Elongation at Break	Tensile Strength (lbs/in)	Size	Qty/Case
<b>3M™ Electroplating Tape 470</b>									
	<ul style="list-style-type: none"> <li>Conformable with excellent resistance to most chemicals used in typical electroplating operations</li> <li>Abrasion resistant backing can protect during bead blasting and shot peening</li> </ul>								
	021200-85616-7	470	Tan	Vinyl	Rubber	180%	20	1" x 36 yds	36
	021200-85617-4							2" x 36 yds	24
<b>3M™ Glass Cloth Tape 361</b>									
	<ul style="list-style-type: none"> <li>Withstands 450°F and intermittent temperatures up to 550°F or higher, depending on heat source</li> <li>Very strong abrasion resistant backing for use as masking protection in thermal spray operations</li> <li>Silicone adhesive provides long aging, good holding power for a wide range of operations</li> <li>Can be certified to meet F.A.R. 25.853, flame resistant specification</li> </ul>								
	021200-03017-8	361	White	Glass Cloth	Silicone	10%	146	1" x 60 yds	36
	021200-04275-1							2" x 60 yds	24
<b>3M™ High Temperature Aluminum Foil/Glass Cloth Tape 363</b>									
	<ul style="list-style-type: none"> <li>High tensile strength, glass cloth reinforced foil tape offers puncture, fracture and tear resistance</li> <li>Performs continuously over a wide temperature range from -65°F/-54°C to 600°F/316°C</li> <li>Light and flexible construction easily conforms to curved or irregular surfaces</li> <li>Thermally conductive and reflective backing assists with heat shielding</li> </ul>								
	021200-17295-3	363	Silver	Aluminum Foil/ Glass Cloth	Silicone	7%	135	2" x 36 yd	24
<b>3M™ Lead Foil Tape 420/421</b>									
	<ul style="list-style-type: none"> <li>Very good conformability and can be die-cut into specific shapes</li> <li>Adhesion to steel: 45 oz/in width</li> <li>Electrically and thermally conductive</li> <li>Good thermal properties; performs over a wide variety of temperatures (-60° to 225°F; -54° to 106°C); use indoors or out</li> </ul>								
	051138-95413-0	420	Dark Silver	Lead Foil	Rubber	12%	20	1" x 36 yds	9
	051138-95414-7							2" x 36 yds	6
	051138-95308-9	421				14%	15	1" x 36 yds	9
	051138-95309-6							2" x 36 yds	6
<b>3M™ Aluminum Foil Tape 425</b>									
	<ul style="list-style-type: none"> <li>Good candidate as a maskant in electroplating of aluminum because it will not contaminate the bath</li> <li>Adhesion to steel: 47 oz/in width</li> <li>An acrylic adhesive, combined with a durable aluminum backing, offers ideal properties for long serviceable life indoors and out</li> <li>Aluminum backing provides excellent reflection of both heat and light</li> </ul>								
	051125-85388-0	425	Shiny Silver	Dead Soft Aluminum	Acrylic	8%	30	1" x 60 yds	36
	051125-85311-8							2" x 60 yds	24
<b>3M™ PTFE Tapes 5490 and 5498</b>									
	<ul style="list-style-type: none"> <li>Non-stick PTFE film lies flatter than typical skived PTFE film tapes and provides an exceptionally slick surface for easy clean-up</li> <li>Silicone adhesive provides clean removal from a variety of surfaces</li> <li>Wide temperature range for performance on heated machinery and equipment</li> <li>Excellent chemical resistance enables tape to withstand challenging applications</li> </ul>								
	021200-07281-9	5490	Gray	PTFE	Silicone	170%	17	1" x 36 yd	9
	021200-07283-3							2" x 36 yd	6
	021200-24842-9	5498	Brown		Rubber	388%	19	1" x 36 yd	36
	021200-24965-5							2" x 36 yd	24
<b>3M™ High Temperature Nylon Film Tape 855</b>									
	<ul style="list-style-type: none"> <li>Excellent for high-temperature applications without silicone adhesives</li> <li>Rubber adhesive removes cleanly after short high temperature bake cycles 400°F (204°C) or extended autoclave cycles to 350°F (177°C)</li> <li>Tough nylon backing adds temperature resistance with one piece removal</li> <li>Elongation properties make for effective masking and faster removal</li> </ul>								
	021200-04354-3	855	White	Nylon	Rubber	460%	32	2" x 72 yds	24
<b>3M™ High Temperature Nylon Film Tape 8555</b>									
	<ul style="list-style-type: none"> <li>Thick 5.0 mil version of 3M™ Nylon Film Tape 855</li> <li>Features excellent performance in high temperature bake cycles (400°F/204°C)</li> <li>Non-silicone adhesive provides clean removal for subsequent bonding or painting</li> <li>Nylon backing offers toughness and high elongation, and removes quickly for simple application</li> </ul>								
	051128-99959-2	8555	White	Nylon	Rubber	375%	95	48" x 72 yds	1
	051128-99957-8							1/2" x 72 yds	72
	021200-24331-8							1" x 72 yds	36
	021200-48785-9							2" x 72 yds	24

## Scotch® Box Sealing Tapes

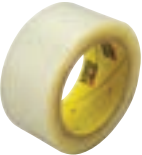

With Scotch® Box Sealing Tapes, you have the flexibility to seal boxes in a wide range of environments for durable and secure closure in packing stations. The tape is tough enough to resist score-line breaking and center-seam splitting, even when subject to rough handling.

Features strong backing with either pressure-sensitive hot melt synthetic rubber resin adhesive or acrylic adhesives for reliable closures. A variety of hand-held dispensers allow for quick and easy application.

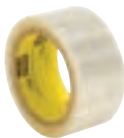

Product	Description	UPC	Backing/ Adhesive	Total Thickness mils (mm)	Color	Size	Qty/ Case
<b>Scotch® Box Sealing Tape 355</b>							
	<ul style="list-style-type: none"> <li>Used for demanding packaging applications</li> <li>Considered water resistant as per ASTM D5570</li> <li>Adheres instantly to most surfaces, including cartons containing high levels of recycled content</li> <li>Superior performance ensures reliable closures</li> <li>Withstands scoreline breaking and center seam splitting</li> </ul>	021200-72330-8	Polyester Film/ Hot Melt Rubber Resin	3.43 (0.089)	Clear	48mm x 50m	36
		021200-72300-1				48mm x 914m	4
		021200-72331-5				72mm x 50m	24
		021200-72333-9				72mm x 914m	2
		051131-06651-9			Tan	48mm x 50m	36
		021200-72327-8				72mm x 50m	24
<b>Scotch® Box Sealing Tape 371</b>							
	<ul style="list-style-type: none"> <li>Industrial packaging tape for medium-duty applications on a wide range of materials</li> <li>High edge tear and split resistance</li> <li>Polypropylene backing with synthetic rubber adhesive delivers conformability under stress</li> </ul>	021200-13679-5	Polypropylene/ Hot Melt Rubber Resin	1.8 (0.046)	Clear	48mm x 50m	36
		021200-19279-1				72mm x 50m	24
		021200-15873-5				48mm x 100m	36
		021200-13681-8				48mm x 914m	6
		021200-61823-9				48mm x 1500m	6
		021200-19280-7				72mm x 100m	24
		021200-18198-6				72mm x 914m	4
		021200-62455-1				72mm x 1500m	4
		021200-14105-8			Tan	48mm x 50m	36
		021200-18197-9				72mm x 50m	24
		021200-15872-8				48mm x 100m	36
		021200-14107-2				48mm x 914m	6
		021200-61525-2				72mm x 100m	24
<b>Scotch® Box Sealing Tape 373</b>							
	<ul style="list-style-type: none"> <li>High performance, ideal for shipping heavy packages on a wide range of material</li> <li>Sturdy polypropylene backing with synthetic rubber adhesive resists abrasions, moisture and scuffing for lasting hold</li> <li>1.6 mil backing and 2.5 mil total thickness for heavy-duty packaging applications</li> <li>Conformable backing flexes under stress</li> </ul>	021200-72368-1	Polypropylene Synthetic Rubber	2.5 (0.064)	Clear	48mm x 50m	36
		021200-72377-3				48mm x 914m	6
		021200-72379-7				48mm x 1500m	3
		021200-69605-3				72mm x 50m	24
		021200-73079-5				48mm x 100m	36
		021200-73080-1				72mm x 100m	24
		021200-72378-0				72mm x 914m	4
		021200-72359-9			Tan	48mm x 50m	36
		021200-72361-2				72mm x 50m	24
		021200-73081-8				48mm x 100m	36
		021200-73082-5				72mm x 100m	24

Note: The technical information and data on these pages should be considered representative or typical only and should not be used for specification purposes.

## Scotch® Box Sealing Tapes



Product	Description	UPC	Backing/ Adhesive	Total Thickness mils (mm)	Color	Size	Qty/ Case
<b>Scotch® Box Sealing Tape 375</b>							
	<ul style="list-style-type: none"> <li>High performance, ideal for shipping heavy packages including overpacked, double or triple-walled boxes</li> <li>Sturdy polypropylene backing with synthetic rubber adhesive resists abrasions, moisture and scuffing for lasting hold</li> <li>2.0 mil backing and 3.1 mil total thickness</li> <li>Conformable backing flexes under stress</li> </ul>	021200-72406-0	Polypropylene/ Hot Melt Rubber Resin	3.1 (0.079)	Clear	48mm x 50m	36
		021200-72408-4				48mm x 914m	6
		021200-72407-7				72mm x 50m	24
		021200-72409-1				72mm x 914m	4
		021200-72401-5				48mm x 50m	36
		021200-72402-2				72mm x 50m	24
<b>Scotch® Box Sealing Tape 311</b>							
	<ul style="list-style-type: none"> <li>Industrial performance box sealing tape designed specifically for utility type applications on light weight boxes</li> <li>Adheres instantly to a variety of surfaces, even in colder and damper environments</li> <li>Backing easily conforms around edges</li> <li>High edge tear and split resistant</li> <li>Good aging in sunlight or fluorescent lighting</li> </ul>	076308-86493-4	Polypropylene/ Pressure Sensitive Acrylic	2.05 (0.052)	Clear	48mm x 100m	36
		076308-86907-6				48mm x 1500m	6
		076308-86494-1				72mm x 100m	24
<b>Tartan™ Box Sealing Tape 305</b>							
	<ul style="list-style-type: none"> <li>General purpose packaging tape used for non-critical box sealing applications</li> <li>A conformable backing</li> <li>Good closure for lightweight boxes exposed to minimal distribution hazards</li> </ul>	021200-39809-4	Polypropylene/ Pressure Sensitive Acrylic	1.8 (0.046)	Clear	48mm x 100m	36
		021200-39810-0				48mm x 914m	6

## Scotch® Box Sealing Tape Dispensers



Product	Description	UPC	Size	Qty/Case
<b>Scotch® Box Sealing Tape Dispenser H122</b>				
	<ul style="list-style-type: none"> <li>Hand braking system lets you control the amount of tape you use</li> <li>Popular, light, plastic, contoured hand held dispenser</li> <li>Small and portable, yet allows you to dispense tape up to 2" wide on a 3" core</li> </ul>	021200-06925-3	48mm (2")	6
<b>Scotch® Low Noise Tape Dispenser H150</b>				
	<ul style="list-style-type: none"> <li>Hand-held, roll-on, pistol-grip dispenser</li> <li>Designed to reduce the noise of tape unwind during application</li> <li>Sturdy, durable, and easy to load and operate</li> <li>Metal and high-impact plastic construction</li> <li>Operates smoothly and quietly, making it usable in noise sensitive places</li> </ul>	021200-39518-5	48mm (2")	6
<b>Scotch® Low Noise Tape Dispenser H153</b>				
	<ul style="list-style-type: none"> <li>Same features as the H150 dispenser</li> <li>Metal and high-impact plastic construction</li> <li>Operates smoothly and quietly, making it usable in noise sensitive places</li> </ul>	021200-39820-9	72mm (3")	6

Note: The technical information and data on these pages should be considered representative or typical only and should not be used for specification purposes.

## Scotch® Box Sealing Tape Dispensers

Product	Description	UPC	Size	Qty/Case
<b>Scotch® Box Sealing Tape Dispenser H180</b>				
	<ul style="list-style-type: none"> <li>• Hand held, portable and easy to use roll-on motion</li> <li>• Features an adjustable, hub-mounted tape brake allowing control of tension and delivery</li> <li>• Dispenses tapes 2" (48mm) wide and is constructed of plastic and metal</li> </ul>	021200-19008-7	48mm (2")	6
<b>Scotch® Box Sealing Tape Dispenser H183</b>				
	<ul style="list-style-type: none"> <li>• Tough enough to operate in high-volume shipping, warehouse and other work environments</li> <li>• Metal and high-impact plastic construction for durability and long-life performance</li> <li>• Hand-held dispenser features adjustable tape brake</li> <li>• Built to dispense wider tapes up to 3" (72mm) wide</li> </ul>	021200-61850-5	72mm (3")	5
<b>Scotch® Box Sealing Tape Dispenser H192</b>				
	<ul style="list-style-type: none"> <li>• Hand control for tighter, more precise seals</li> <li>• High impact plastic construction</li> <li>• Dispenses box sealing tape up to 2" (48mm) wide</li> </ul>	021200-86512-1	48mm (2")	6

## 3M™ Duct Tapes

Product	Description	UPC	Backing/ Adhesive	Total Thickness mils (mm)	Temperature Range °F (°C)	Color	Size	Qty/ Case
<b>3M™ Performance Plus Duct Tape 8979</b>								
	<ul style="list-style-type: none"> <li>• <b>Class 1: Clean Removal Duct Tape</b></li> <li>• Removes cleanly from most opaque surfaces for up to six months</li> <li>• Indoors or outdoors, this tape stays on the job without deteriorating for up to twelve months</li> <li>• Water resistant and sunlight/UV resistant</li> </ul>	048011-53922-5	Polyethylene film over cloth scrim/ Rubber	12.1 (0.31)	Up to 200°F (93°C)	Slate Blue	24mm x 54.8mm	48
		021200-56468-0					48mm x 54.8mm	24
		021200-56469-7					72mm x 54.8mm	12
		021200-56470-3					96mm x 54.8mm	12
<b>3M™ Multi-Purpose Duct Tape 3900</b>								
	<ul style="list-style-type: none"> <li>• <b>Class II: Heavy Duty Duct Tape</b></li> <li>• Polyethylene coated cloth with rubber adhesive</li> <li>• General purpose duct tape</li> <li>• Good choice for general maintenance, wrapping, sealing and protecting</li> </ul>	051131-06976-3	Polyethylene film over cloth scrim/ Rubber	7.6 (0.19)	Up to 200°F (93°C)	Silver	48mm x 54.8mm	24
		021200-49833-6				Black	48mm x 54.8mm	24
		021200-49828-2				Yellow	48mm x 54.8mm	24
<b>3M™ Vinyl Duct Tape 3903</b>								
	<ul style="list-style-type: none"> <li>• <b>Class III: Utility Duct Tape</b></li> <li>• Embossed vinyl film coated with rubber adhesive</li> <li>• Designed for general sealing, color coding, masking, wrapping and bundling, protecting and other light duty applications where easy unwind, easy tear is important</li> </ul>	051131-06984-8	Embossed Vinyl/ Rubber	7.3 (0.19)	Up to 200°F (93°C)	Gray	2" x 50 yds	24
		051131-06995-4				Black	2" x 50 yds	24
		051131-06982-4				Yellow	2" x 50 yds	24









Note: The technical information and data on these pages should be considered representative or typical only and should not be used for specification purposes.

# Safety Products

## 3M™ Particulate Respirators

**WARNING:** Before use of these respiratory protection products, a written respiratory protection program must be implemented, meeting all the requirements of OSHA 29 CFR 1910.134 such as training, fit testing, medical evaluation and applicable OSHA substance specific standards. **Misuse may result in sickness or death.**

**PLEASE NOTE:** All products contain Advanced Electrostatic Media, noseclip and two straps.

3M™ Particulate Respirator	UPC	Suggested Application	Nose Foam	3M™ Cool Flow™ Valve	Braided Comfort Strap	Carbon Media	Nose-clip	Welding Web	Adj Straps	Individual Additional Features	Qty/Case
<b>Dusty Conditions</b>											
	8210, N95	051138-46457-3	Grinding, Bagging, Sanding, Sweeping, Other dusty operations	●			A			Proprietary Filter Media	160
	8210V, N95	051131-49711-0	Grinding, Bagging, Sanding, Sweeping, Other dusty operations	●	●		A			Proprietary Filter Media	80
	8271, P95	051138-54285-1	Grinding, Machining, Sanding, Sweeping, Other dusty/hot/oily operations		●	●	M			Proprietary Filter Media, Faceseal	80
	8511, N95	051138-54343-8	Grinding, Bagging, Sanding, Sweeping, Other hot/dusty operations		●	●	M			Proprietary Filter Media, Soft Inner Materials	80
<b>Welding and Metal Pouring</b>											
	8212, N95	051138-54141-0	Welding, Torch cutting, Brazing, Soldering, Metal pouring		●	●	A	●	●	Proprietary Filter Media, Faceseal, Cake Resistant Media	80
	8214, N95	051138-66192-7	Welding, Torch cutting, Brazing, Soldering, Metal pouring, Stainless, Galvanized		●	●	OV* OZ**	A	●	Proprietary Filter Media, Faceseal, Cake Resistant Media	80
	8514, N95	051138-66299-3	Welding, Soldering and other applications where metal fumes are present including ozone**and nuisance level organic vapors*	●	●	●	OV* OZ**	A	●	Proprietary Filter Media, Cake Resistant Media	80
	8515, N95	051131-07189-1	Welding, Torch cutting, Brazing, Soldering		●	●	M	●		Proprietary Filter Media	80

\*OV: 3M recommended for relief against nuisance levels of organic vapors. Nuisance level refers to concentrations not exceeding the OSHA PEL or applicable government exposure limits, whichever is lower.





\*\*OZ: 3M recommended for ozone protection up to 10 times the OSHA PEL. Not NIOSH approved for use against ozone.

M = M-noseclip

A = Adjustable noseclip

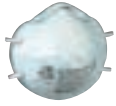
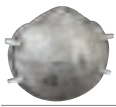
3M PPE products are for occupational use only. See warnings on page 126.

# 3M™ Particulate Respirators

3M™ Particulate Respirator	Suggested Application	UPC	Nose Foam	3M™ Cool Flow™ Valve	Braided Comfort Strap	Carbon Media	Nose-clip	Welding Web	Adj Straps	Individual Additional Features	Qty/Case
<b>Nuisance Level Odor</b>											
	8246, R95	Aluminum, Smelting, Paper processing, Brewing operations, Glass etching, Chemical processing	051131-54357-5	●	●	AG+	A			—	120
	8247, R95	Foundry operations, Undercoating, Lab settings, Agriculture, Petrochemical processing	051131-54358-2	●	●	OV*	A			—	120
	8516, N95	Aluminum, Smelting, Paper processing, Brewing operations, Glass etching, Chemical processing	051131-66392-1		●	●	AG+	M		Soft Inner Materials	80
	8576, P95	Aluminum, Smelting, Paper processing, Brewing operations, Glass etching, Chemical processing	051131-54370-4		●	●	AG+	M		Soft Inner Materials	80
	8577, P95	Foundry operations, Undercoating, Lab settings, Agriculture, Petrochemical processing	051131-54371-1		●	●	OV*	M		Soft Inner Materials	80









\*OV: 3M recommended for relief against nuisance levels of organic vapors. Nuisance level refers to concentrations not exceeding the OSHA PEL or applicable government exposure limits, whichever is lower.

\*AG: 3M recommended for relief against nuisance level acid gases. Nuisance level refers to concentrations not exceeding the OSHA PEL or applicable government exposure limits, whichever is lower.

M = M-noseclip

A = Adjustable noseclip

## Technologies

	<b>3M™ Cool Flow™ Exhalation Valve.</b> Helps reduce heat and humidity build-up inside the respirator.		<b>Advanced Electrostatic Media.</b> Electrostatically charged microfibers help make breathing easier.		<b>Adjustable Buckle Straps.</b> A single tug helps provide a comfortable, secure fit.
	<b>M-noseclip.</b> Adjusts easily for fewer pressure points and greater comfort.		<b>Carbon Filter Material.</b> Carbon layers remove many nuisance level odors* for greater wearer comfort.		<b>P-series Filter.</b> Featuring Advanced Electrostatic Media, appropriate for prolonged use in oil and non-oil containing environments.
	<b>Face Seal.</b> Soft and secure, conforms closely to face for long-lasting comfort.		<b>Cake-resistant Filter Media.</b> Specially designed filter layers for welding provide longer respirator life and easier breathing.		<b>Compatibility.</b> Accommodates a wide range of safety equipment, including eye and hearing protection.

\*Nuisance level odors refers to concentrations not exceeding the OSHA PEL or other applicable government exposure limits, whichever is lower.

3M PPE products are for occupational use only. See warnings on page 126.

# 3M™ Full and Half Facepiece Reusable Respirators

3M provides a full line of reusable respirators to meet the needs of most work environments. Half or full facepiece reusable respirators help protect against both particles and/or gases and vapors.

## 1. Choose Facepiece

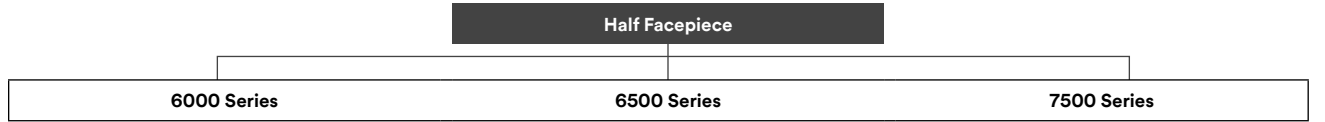

### Features and Benefits

- Made from soft, lightweight thermoplastic elastomer
- Easy to adjust head straps
- Supplied with reclosable storage bag
- Swept back design improves balance and visibility
- NIOSH approved for negative pressure air purifying and supplied air dual airline applications
- Can be used with 3M™ Filters and Cartridges or 3M™ Dual Airline System



### Features and Benefits

- Resilient silicone face seal provides comfort, durability, and stability with a soft but firm seal
- Optional Quick Latch mechanism makes it easy to drop down the respirator from face without removing head straps
- Cool Flow™ Valve helps make breathing easier with unique valve design and enhanced comfort by reducing heat and moisture
- Adjustable Head Harness for comfort with three-size adjustable head cradle
- Easy on and off as you move in and out of contaminated areas



### Features and Benefits

- Advanced silicone material for increased comfort and greater durability
- Head harness design allows respirator to be worn in drop-down mode when used in non-hazardous environments
- 3M™ Cool Flow™ Exhalation Valve helps direct hot, humid exhaled air outside the respirator



## Full Facepiece

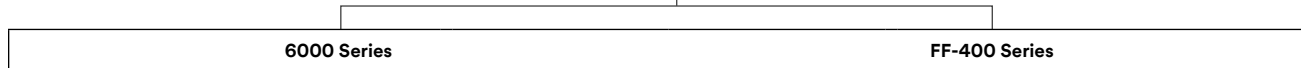

### Features and Benefits

- Soft, silicone face seal
- Four strap suspension for easy donning and doffing
- Bayonet attachment
- Wide field of vision
- Meets the requirements of ANSI Z87.1-2010 standard for face and eye protection
- Valve cover directs exhaled breath and moisture downward
- Available with negative pressure and dual airline models



### Features and Benefits

- Large lens featuring Scotchgard™ Protector
- Passive speaking diaphragm
- Meets the requirements of ANSI Z87.1-2010 standard for face and eye protection
- Durable, long-lasting head harness and comfort cradle
- Soft, silicone nose cup and face seal



## 3M™ Half Facepiece Respirator

UPC	Product	Model	Size	Qty/Case
051131-07024-5	6000 Series	6100	S	24
051131-07025-2	6000 Series	6200	M	24
051131-07026-9	6000 Series	6300	L	24
051131-49488-1	6500 Series	6501QL	S	10
051131-49490-4	6500 Series	6502QL	M	10
051131-49492-8	6500 Series	6503QL	L	10
051131-37081-9	7500 Series	7501	S	10
051131-37082-6	7500 Series	7502	M	10
051131-37083-3	7500 Series	7503	L	10

## 3M™ Full Facepiece Respirator

UPC	Product	Model	Size	Qty/Case
051131-54145-8	6000 Series	6700	S	4
051131-54146-5	6000 Series	6800	M	4
051131-54159-5	6000 Series	6900	L	4
051135-89418-2	FF-400 Series	FF-401	S	4
051135-89421-2	FF-400 Series	FF-402	M	4
051135-89424-3	FF-400 Series	FF-403	L	4

Note: When used in supplier air mode, employer must provide a minimum of Grade D breathing air in accordance with OSHA requirements.

3M PPE products are for occupational use only. See warnings on page 126.

# 3M™ Particulate Filters and Gas/Vapor Cartridges

These filters and cartridges can be used interchangeably with 3M™ Reusable Respirators 6000, 6500, 7500, 7800S and FF-400 Series Full and Half Facepieces.

## 2. Choose Filter/Cartridge Combination

### Particles

#### 3M™ Particulate Filters 2000 Series

- 99.97% filter efficiency meets NIOSH P100-series test criteria
- Protection against oil and non-oil based particulate contaminants
- Bayonet compatibility allows use with many 3M half and full facepiece designs
- The 3M 2200 Series is engineered with 3-layer advanced Electrostatic Filter Media for even easier breathing and is approximately 25% easier to breathe through compared with the standard 2000 Series\*
- The 3M 2200 Series is engineered with more advanced netting construction technology to increase durability



UPC	Product	Description	Qty/Case
051131-07000-9	2091	Particulate Filter, P100	100
051131-07184-6	2097	Particulate Filter, P100, with Nuisance Level Organic Vapor Relief**	100
051131-17170-6	2291	Advanced Particulate Filter, P100	100
051131-17172-0	2297	Advanced Particulate Filter, P100, with Nuisance Level Organic Vapor Relief**	100

### Gases and Vapors

#### 3M™ Gas/Vapor Cartridges 6000 Series and 95 Class Filters

- Full range of cartridges and filters to meet your needs
- Swept-back design allows an enhanced field of view and comfort
- Bayonet compatibility allows use with many 3M half and full facepiece designs



UPC	Product	Description	Qty/Case
051138-21674-5	6001	Cartridge, Organic Vapor	60
051138-07047-4	6003	Cartridge, Organic Vapor/Acid Gas	60
051138-54186-1	6006	Cartridge, Multi Gas/Vapor	60
051138-17668-1	501	Filter Retainer	100
051138-46464-1	5N11	N95 Prefilter	100
051138-07668-5	5P71	P95 Prefilter	100

### Particles and Vapors

#### 3M™ Combination Cartridges/P100 Particulate Filters 6000 Series

- P100 Particulate filter is permanently attached to cartridge for easy, one-step assembly
- Full range of cartridges
- Swept-back design allows an enhanced field of view and comfort
- Bayonet compatibility allows use with many 3M half and full facepiece designs



UPC	Product	Description	Qty/Case
051138-46465-8	60921	Cartridge/Filter, Organic Vapor/P100	60
051138-46467-2	60923	Cartridge/Filter, Organic Vapor/Acid Gas/P100	60
051138-54187-8	60926	Cartridge/Filter, Multi-Gas/Vapor/P100	60

\*Percent change based on the 95% confidence interval for the mean initial pressure drop for 2200 and 2000. The 3M 2291 filter is 26% easier to breathe through than the 3M 2091 filter, and the 3M 2297 filter is 28% easier to breathe through than the 3M 2097 filter.

\*\*3M recommended for relief against nuisance levels of organic vapors. Nuisance level organic vapor refers to concentrations not exceeding OSHA PEL or applicable government occupational exposure limits, whichever is lower. Do not use for respiratory protection against organic vapors.

3M PPE products are for occupational use only. See warnings on page 126.

# 3M™ Welding Products



06-0100-30iSW

## 3M™ Speedglas™ Welding Helmet Series 9100

- 3M™ Speedglas™ Filter 9100XX and 9100XXi are 30% larger than any other Speedglas™ welding filter
- Seven user selectable dark shades for most types of arc welding
- Built in magnifying lens holder making installation easier

UPC	Product	Description	Qty/Case
051131-49527-2	06-0100-30HASW	3M™ Speedglas™ Welding Helmet 9100 with Hard Adapter, SideWindows, 3M™ Speedglas™ Auto-Darkening Filter 9100XX (Hard Hat not included)	1
051141-56475-3	06-0100-30iSW	3M™ Speedglas™ Welding Helmet 9100 with Auto-Darkening Filter 9100XXi	1

## 3M™ Speedglas™ Welding Helmet 9002NC

- Dual dark shade 8–12
- Sleek, signature design for a modern, professional look
- Helmet exhaust vents provide comfort
- Comes with 3M™ Speedglas™ welding filter 9002NC, using natural color technology auto-darkening filter



04-0100-20NC

UPC	Product	Description	Qty/Case
051131-27607-9	04-0100-20NC	3M™ Speedglas™ Welding Helmet 9002NC	1

## 3M™ Speedglas™ G5-01 and 9100MP Welding Helmets

- Clear, wide grinding visor offers a greater field of view in all directions, while a smooth flip-up pivot mechanism assures effortless transition from welding to grinding modes
- G5-01VC welding filter features our first ever Variable Color Technology which allows welders to select between 3 different color options (clear, cool, or warm). These variable colors may allow welders to improve their ability to see the weld puddle, joint, and arc better than our previous filters. Dark shade options include 5, 8-14



46-1101-30iVC

46-5702-30iVC

37-1101-30iSW

UPC	Product	Description	Qty/Case
076308-94489-6	46-1101-30iVC	3M™ Speedglas™ Heavy-Duty Welding Helmet G5-01 with ADF G5-01VC and 3M™ Adflo™ High-Altitude PAPR Assembly	1
076308-94491-9	46-5702-30iVC	3M™ Speedglas™ Heavy-Duty Welding Helmet G5-01 with 3M™ V-100 Vortex™ Cooling Valve Assembly, ADF G5-01VC, 46-5702-30iVC	1
076308-94383-7	37-1101-30iSW	3M™ Adflo™ PAPR with 3M™ Speedglas™ Welding Helmet 9100MP 37-1101-30iSW, HE filter, Lithium Ion Battery, Hard Hat, ADF 9100XXi	1

## 3M™ Welding Helmet, Welding Safety M-409SG

- Helmet with integrated face shield and welding shield with Assigned Protection Factor (APF) of 1000
- For use with Speedglas™ 9100 Series Auto-Darkening Filter
- May be configured for use with either Adflo™ or Versaflo™ Turbo Units and Supplied Air



M-409SG

UPC	Product	Description	Qty/Case
076308-94282-3	M-409SG	3M™ Versaflo™ Respiratory M-Series Helmet Assembly Leather Shroud, Flame Resistant Helmet Cover and Speedglas™ Weld Shield (No ADF) M-409SG	1

## 3M™ Versaflo™ M-Series Faceshields, Hard Hats and Helmets

- Lightweight, compact and easy to maintain, 3M headgear for powered and Supplied Air respirators protect from a range of hazards
- Versatility and comfort helps make them popular for many applications



M-207



M-307



M-407

UPC	Product	Description	Qty/Case
051141-56740-2	M-207	3M™ Versaflo™ Respiratory Faceshield M-207	1
051131-17317-0	M-307	3M™ Versaflo™ Respiratory Hardhat Assembly M-307 with Premium Visor and Face Seal	1
051131-17323-1	M-407	3M™ Versaflo™ Respiratory Helmet Assembly M-407 with Premium Visor and Flame Resistant Shroud	1

3M PPE products are for occupational use only. See warnings on page 126.

# 3M™ Welding Products

## Take a good look

Improved optics in the 3M™ Speedglas™ 9100XXi and 9002NC Welding Filters help you see your welds in a new light, providing more contrast and natural-looking color as shown in these photos.



9100XXi and 9002NC  
ADF Shade 3



Traditional Speedglas™  
ADF Shade 3



Sample Competitor  
ADF Shade 3

Product	UPC	Product	Abbreviated Description	Qty/Case
<b>3M™ Speedglas™ Welding Helmet Accessories</b>				
	051141-56473-9	06-0000-30i	3M™ Speedglas™ 9100XXi Auto Darkening Filter 06-0000-30i, Shades 5, 8-13	1
	051131-49677-4	06-0700-51	3M™ Speedglas™ Wide-View Clear Grinding Visor 9100 FX	5
	051141-56193-6	06-0200-51-B	3M™ Speedglas™ Outside Protection Plate 9100, Standard	50
	051141-56195-0	06-0200-52-B	3M™ Speedglas™ Outside Protection Plate 9100, Scratch Resistant	
	051135-89399-4	06-0200-53-B	3M™ Speedglas™ Outside Protection Plate 9100, High Temperature	
	051141-56138-2	06-0200-10-B	3M™ Speedglas™ Inside Protection Plate 9100V	25
	051141-56140-5	06-0200-20-B	3M™ Speedglas™ Inside Protection Plate 9100X	
	051141-56142-9	06-0200-30-B	3M™ Speedglas™ Inside Protection Plate 9100XX	
<b>3M™ Adflo™ PAPR Accessories</b>				
	051131-92600-9	15-0299-99×06	3M™ Adflo™ Powered Air Purifying Respirator (PAPR) High Efficiency Particulate Filter	6
	051131-92601-6	15-0299-99×36	3M™ Adflo™ Powered Air Purifying Respirator (PAPR) High Efficiency Particulate Filter	36
	051131-37144-1	15-0099-99×06	3M™ Adflo™ Prefilter	6
	051131-92598-9	15-0099-99×12	3M™ Adflo™ Prefilter	12
	051141-56084-7	35-0699-99X01	3M™ Adflo™ PAPR Nuisance Odor Pad Assembly	1
	051131-49901-5	15-0499-99×02	3M™ Adflo™ Replacement Cartridges, Organic Vapor/Acid Gas(OV/SD/CL/HC)	2
	051141-56081-6	35-0099-08	3M™ Adflo™ PAPR Battery Smart Charger for Lithium Ion Battery	1
	051141-56082-3	35-1099-07	3M™ Adflo™ Powered Air Purifying Respiratory (PAPR) Battery, Lithium Ion	1
	051131-37268-9	SG-30W	3M™ Speedglas™ Self-Adjusting Breathing Tube	1
<b>3M™ Versaflo™ Back Pack</b>				
	051131-17358-3	BPK-01	3M™ Versaflo™ Back Pack for Adflo™ and TR-600/800 PAPR	1

3M PPE products are for occupational use only. See warnings on page 126.

Safety Products

# Hearing Conservation











3M offers a wide variety of solutions to help reduce noise exposure. A full line of comfortable, easy-to-use hearing protectors, including earplugs, earmuffs, and banded hearing protectors are available from 3M.

Product	UPC	Product	Abbreviated Description	NRR*	Qty/Case
<b>One Touch™ Pro Earplug Dispenser and Refill Bottles</b>					
	078371-66803-7	391-0000	One Touch™ Pro Earplug Dispenser	N/A	1
	080529-91001-1	391-1001	Classic™ Refill Bottle	29 dB	2,000
	080529-91002-8	391-1002	Classic™ SuperFit™ 30 Refill Bottle	30 dB	2,000
	080529-91004-2	391-1004	E-A-Rsoft™ Yellow Neons™, Regular Refill Bottle	33 dB	2,000
	080529-91005-9	391-1005	E-A-Rsoft™ Yellow Neons™, Large Refill Bottle	33 dB	1,600
	080529-91012-7	391-1010	E-A-Rsoft™ Yellow Neon Blasts™ Refill Bottle	33 dB	2,000
	080529-91010-3	391-1254	E-A-Rsoft™ SuperFit™ Refill Bottle	33 dB	2,000
	080529-19102-1	391-1100	1100 Foam Earplug, Refill Bottle	29 dB	2,000
	078371-66832-7	391-1012	E-A-Rsoft™ FX™ One Touch™ Refill Bottle	33 dB	2,000
	078371-67050-4	391-0010	One Touch™ Pro Adapter Plate	N/A	1
<b>E-A-R™ Classic™ Earplugs</b>					
	080529-10000-6	310-1001	Uncorded, Pillow Pack	29 dB	2,000
	080529-11001-2	311-1101	Corded, Poly Bag	29 dB	2,000
	080529-12002-8	312-1201	Uncorded, Poly Bag	29 dB	2,000
	093045-93247-1	VP311-1101	Corded, Vending Pack	29 dB	500
	080529-19091-5	VP312-1201	Uncorded, Vending Pack	29 dB	500
	080529-10052-5	310-1103	Small, Uncorded, Pillow Pack	29 dB	2,000
	080529-11024-1	311-1106	Small, Corded, Poly Bag	29 dB	2,000
<b>E-A-R™ Classic™ Superfit™ Earplugs</b>					
	080529-10063-1	310-1009	Uncorded, Pillow Pack	30 dB	2,000
	080529-11050-0	311-1126	Corded, Poly Bag	30 dB	2,000
<b>E-A-R™ Classic™ Grippers™ Earplugs</b>					
	080529-12090-5	312-6001	Corded, Poly Bag	31 dB	2,000
<b>E-A-Rsoft™ Yellow Neons™ Earplugs</b>					
	080529-10065-5	310-1250	Regular, Uncorded, Pillow Pack	33 dB	2,000
	080529-11033-3	311-1250	Regular, Corded, Poly Bag	33 dB	2,000
	080529-11034-0	311-1251	Large, Corded, Poly Bag	33 dB	2,000
	080529-12064-6	312-1251	Large, Uncorded, Poly Bag	33 dB	2,000
<b>E-A-Rsoft™ Yellow Neon Blasts™ Earplugs</b>					
	080529-11035-7	311-1252	Corded, Poly Bag	33 dB	2,000
	080529-12065-3	312-1252	Uncorded, Poly Bag	33 dB	2,000
<b>3M™ Foam Earplugs</b>					
	051138-29008-0	1100	Uncorded, Poly Bag	29 dB	1,000
	051138-29009-7	1110	Corded, Poly Bag	29 dB	500
<b>E-A-R™ UltraFit™ Earplugs</b>					
	080529-40000-7	340-4001	Uncorded, Carrying Case	25 dB	200
	080529-40001-4	340-4002	Corded, Carrying Case	25 dB	200
	080529-40002-1	340-4003	Uncorded, Poly Bag	25 dB	400
	080529-40003-8	340-4004	Corded, Poly Bag	25 dB	400
	093045-93248-8	VP340-4004	Corded, Vending Pack	25 dB	500
<b>E-A-R™ UltraFit™ Silicone Earplugs</b>					
	051131-27515-2	340-3002	Corded, Carrying Case	24 dB	400

\*NOTE: U.S. EPA specifies the NRR as the measure of hearing protector noise reduction. However, 3M makes no warranties as to the suitability of the NRR for this purpose. 3M strongly recommends personal fit testing of hearing protectors. Research suggests that users may receive less noise reduction than indicated by the attenuation label value(s) on the packaging due to variation in fit, fitting skill, and motivation of the user. Refer to applicable regulations for guidance on how to adjust attenuation label values. It is recommended that the NRR be reduced by 50% to better estimate typical protection.

3M PPE products are for occupational use only. See warnings on page 126.





# Hearing Conservation

Product	UPC	Product	Abbreviated Description	NRR*	Qty/Case
<b>Tri-Flange™ Earplugs</b>					
	093045-98016-8	P3000	Vinyl Cord, Poly Bag	26 dB	400
	093045-98017-5	P3001	Cloth Cord, Poly Bag	26 dB	400
<b>E-A-R™ Push-Ins™ Earplugs</b>					
	080529-18000-8	318-1000	Uncorded, Poly Bag	28 dB	400
	080529-18001-5	318-1001	Corded, Poly Bag		
	080529-18004-6	318-1004	Uncorded, Econopack	28 dB	1500
	080529-18005-3	318-1005	Corded, Econopack		
	080529-19092-2	VP318-1001	Corded, Vending Pack	28 dB	500
<b>E-A-R™ Flexible Fit Earplugs</b>					
	051131-27932-2	328-1000	Uncorded, Poly Bag	25 dB** or 30 dB**	400
	051131-27940-7	328-1001	Corded, Poly Bag		
<b>Pistonz™ Earplugs</b>					
	093045-93401-7	P1400	Uncorded, Poly Bag	29 dB	400
	093045-93402-4	P1401	Corded, Poly Bag		
<b>Skull Screws™ Earplugs</b>					
	093045-92951-8	P1300	Uncorded, Poly Bag	32 dB	480
	093045-92952-5	P1301	Corded, Poly Bag		
	080529-19142-4	VP-P1301	Corded, Vending Pack	32 dB	500
<b>No Touch Earplugs</b>					
	093045-98014-4	P2000	Uncorded, Poly Bag	29 dB	400
	093045-98015-1	P2001	Corded, Poly Bag		
<b>PELTOR™ Optime™ 95 Earmuffs</b>					
	093045-08062-2	H6B/V	Behind-the-Head	21 dB	10
<b>PELTOR™ Optime™ 101 Earmuffs</b>					
	093045-08072-1	H7B	Behind-the-Head	26 dB	10
<b>PELTOR™ Optime™ 105 Earmuffs</b>					
	093045-08102-5	H10B	Behind-the-Head	29 dB	10
<b>PELTOR™ Welding</b>					
	093045-93640-0	H505B	Behind-the-Head	17 dB	10
<b>PELTOR™ Earmuffs X Series</b>					
	093045-93723-0	X1A	Over-the-Head, Green	22 dB	10
	093045-93724-7	X2A	Over-the-Head, Yellow	24 dB	
	093045-93725-4	X3A	Over-the-Head, Red	28 dB	
	093045-93726-1	X4A	Over-the-Head, Light Green	27 dB	
	093045-93727-8	X5A	Over-the-Head, Black	31 dB	

\*NOTE: U.S. EPA specifies the NRR as the measure of hearing protector noise reduction. However, 3M makes no warranties as to the suitability of the NRR for this purpose. 3M strongly recommends personal fit testing of hearing protectors. Research suggests that users may receive less noise reduction than indicated by the attenuation label value(s) on the packaging due to variation in fit, fitting skill, and motivation of the user. Refer to applicable regulations for guidance on how to adjust attenuation label values. It is recommended that the NRR be reduced by 50% to better estimate typical protection.

\*\*Noise Reduction Rating (NRR) 25 dB for one-hand insertion and 30 dB for two-hand insertion.

# 3M™ Protective Eyewear

Product	UPC	Product	Color	Qty/Case	Features
<b>3M™ SecureFit™ Protective Eyewear – 200 Series</b>					
	078371-65717-5	SF201AF	Lens: Clear Frame: Clear Coating: Anti-Fog/Anti-Scratch	20	<ul style="list-style-type: none"> <li>Secure, comfortable fit with 3M™ Pressure Diffusion Temple (PDT) Technology</li> <li>Polycarbonate lens absorbs 99.9% UVA &amp; UVB; meets the requirements of ANSI Z87.1-2015</li> <li>Contemporary and lightweight, weighs less than 1 ounce</li> <li>Molded nose bridge</li> </ul>
	078371-65720-5	SF201AS	Lens: Clear Frame: Clear Coating: Anti-Scratch		
	078371-65718-2	SF202AF	Lens: Gray Frame: Gray Coating: Anti-Fog/Anti-Scratch		
	078371-65721-2	SF202AS	Lens: Gray Frame: Gray Coating: Anti-Scratch		
	078371-65719-9	SF203AF	Lens: Amber Frame: Amber Coating: Anti-Fog/Anti-Scratch		
	078371-65722-9	SF203AS	Lens: Amber Frame: Amber Coating: Anti-Scratch		
<b>3M™ SecureFit™ Protective Eyewear – 400 Series</b>					
	051131-27715-1	SF401SGAF-RED	Lens: Clear Frame: Red/Gray Coating: Scotchgard™ Anti-Fog/Anti-Scratch	20	<ul style="list-style-type: none"> <li>Motion-inspired, contoured piping in bold, modern colors</li> <li>Proprietary 3M™ Pressure Diffusion Temple (PDT) Technology minimizes pressure over the ear without compromising security</li> <li>Available in a variety of lens colors for a range of applications; polycarbonate lenses absorb 99.9% of UVA and UVB rays</li> <li>All options meet the requirements of ANSI Z87.1 Standard as an Impact Rated spectacle</li> <li>Effective for at least 25 washes with water,* 3M™ Scotchgard™ Protector Anti-Fog Coating provides abrasion and fog resistance</li> </ul>
	051131-27728-1	SF401SGAF-BLU	Lens: Clear Frame: Blue/Gray Coating: Scotchgard™ Anti-Fog/Anti-Scratch		
	051131-27731-1	SF401SGAF-BLU-F	Lens: Clear w/Foam Gasket Frame: Blue/Gray Coating: Scotchgard™ Anti-Fog/Anti-Scratch		
	051131-27734-2	SF402SGAF-BLU	Lens: Gray Frame: Blue/Gray Coating: Scotchgard™ Anti-Fog/Anti-Scratch		
	051131-27735-9	SF403SGAF-YEL	Lens: Amber Frame: Yellow/Black Coating: Scotchgard™ Anti-Fog/Anti-Scratch		
	051131-27729-3	SF407SGAF-BLU	Lens: Indoor/Outdoor Gray Frame: Blue/Gray Coating: Scotchgard™ Anti-Fog/Anti-Scratch		
	078371-66211-7	SF401AF	Lens: Clear Frame: Green/Black Coating: Anti-Fog/Anti-Scratch	20	<ul style="list-style-type: none"> <li>Secure, comfortable fit with 3M™ Pressure Diffusion Temple (PDT) Technology</li> <li>Dual-injected, padded temple touchpoints for added comfort over ears</li> <li>Motion-inspired, contoured piping in a bold modern color palette for an infusion of style</li> <li>Soft one-piece nose bridge</li> <li>Optional removable foam-lined gasket helps keep debris out of your eyes while providing comfort and cushioning</li> </ul>
	051131-27475-9	SF401AF-FM	Lens: Clear w/Foam Gasket Frame: Green/Black Coating: Anti-Fog/Anti-Scratch		
	051131-27565-7	SF402AF-FM	Lens: Gray w/Foam Gasket Frame: Green/Black Coating: Anti-Fog/Anti-Scratch	20	
	078371-66213-1	SF410AS	Lens: Indoor/Outdoor Mirror Frame: Green/Black Coating: Anti-Scratch	20	

\*Based on 3M internal testing per EN168 test method when compared with traditional anti-fog coatings.







3M PPE products are for occupational use only. See warnings on page 126.

# 3M™ Protective Eyewear

Product	UPC	Product	Color	Qty/Case	Features
<b>3M™ SecureFit™ Protective Eyewear – 600 Series</b>					
	051131-27337-0	SF601SGAF	Lens: Clear Frame: Gray Coating: Scotchgard™ Anti-Fog/ Anti-Scratch	20	<ul style="list-style-type: none"> <li>Secure, comfortable fit with 3M™ Pressure Diffusion Temple (PDT) Technology</li> <li>Long lasting clarity with 3M™ Scotchgard™ Anti-fog Coating which retains its effectiveness for at least 25 washings with water</li> <li>Stylish yet sturdy frame that nearly anyone can wear</li> <li>Optional removable foam-lined gasket helps keep debris out of your eyes while providing comfort and cushioning</li> <li>Additional personal protective equipment may be required for SF617AS, SF630AS and SF650AS</li> </ul>
	051131-27340-0	SF601SGAF-FM	Lens: Clear w/ Foam Gasket Frame: Gray Coating: Scotchgard™ Anti-Fog/ Anti-Scratch		
	051151-27338-7	SF602SGAF	Lens: Gray Frame: Gray Coating: Scotchgard™ Anti-Fog/ Anti-Scratch		
	051131-27344-8	SF617AS	Lens: Low IR Frame: Gray Coating: Anti-Scratch	20	
	051131-27345-5	SF630AS	Lens: Shade 3 Frame: Gray Coating: Anti-Scratch		
	051131-27346-2	SF650AS	Lens: Shade 5 Frame: Gray Coating: Anti-Scratch		
<b>3M™ Solus™ – 1000 Safety Eyewear</b>					
	051131-27186-4	S1101SGAF	Clear Scotchgard™ Anti-Fog Lens, Blue/Black Frame	20	<ul style="list-style-type: none"> <li>Long lasting clarity with 3M™ Scotchgard™ Protector Anti-Fog Coating which retains its effectiveness for at least 25 washings with water</li> <li>Lens colors: Clear and Gray</li> <li>Removable temples</li> <li>Soft nose bridge</li> <li>Padded temples for added comfort</li> <li>Optional vented, removable foam gasket to help reduce eye exposure</li> <li>Optional elastic strap helps keep eyewear in place</li> </ul>
	051131-27189-5	S1101SGAF-KT	<b>Kit:</b> Clear Scotchgard™ Anti-Fog Lens, Blue/Black Frame, Foam Gasket and Strap		
	051131-27187-1	S1102SGAF	Gray Scotchgard™ Anti-Fog Lens, Blue/Black Frame	20	
	051131-27557-2	S1102SGAF-KT	<b>Kit:</b> Gray Scotchgard™ Anti-Fog Lens, Blue/Black Frame, Foam Gasket and Strap		
	051131-27182-6	S1201SGAF	Clear Scotchgard™ Anti-Fog Lens, Green/Black Frame	20	
	051131-27185-7	S1201SGAF-KT	<b>Kit:</b> Clear Scotchgard™ Anti-Fog Lens, Green/Black Frame, Foam Gasket and Strap		
	051131-27183-3	S1202SGAF	Gray Scotchgard™ Anti-Fog Lens, Green/Black Frame	20	
	051131-27573-2	S1202SGAF-KT	<b>Kit:</b> Gray Scotchgard™ Anti-Fog Lens, Green/Black Frame, Foam Gasket and Strap		









## 3M™ DBI-SALA® Fall Protection

The Height of Confidence — It is our mission at 3M to provide those responsible for the safety of workers at height with reliable fall arrest equipment. We offer the knowledge and support to help take the fear out of working at height.

Product	Description	Part / UPC	Qty
<b>Harness</b>			
 <p>1112478</p>	 <p>1113010</p>	<p><b>3M™ DBI-SALA® ExoFit™ STRATA™</b></p> <ul style="list-style-type: none"> <li>• Vest-style, full-body safety harness</li> <li>• Aluminum back D-ring</li> <li>• Tri-Lock Revolver™ Quick-Connect Buckles</li> <li>• Comfort padding</li> <li>• Size: XLarge</li> </ul>	<p>1112478 840779-10927-2</p> <p>1</p>
 <p>1103088</p>	 <p>1105475</p>	<p><b>3M™ DBI-SALA® ExoFit™ NEX™ Arc Flash</b></p> <ul style="list-style-type: none"> <li>• Vest-style, full-body safety harness</li> <li>• Nomex®/Kevlar® fiber web for hot work use</li> <li>• PVC-coated aluminum back D-ring</li> <li>• Locking quick-connect buckles</li> <li>• Comfort padding</li> <li>• Size: XLarge</li> </ul>	<p>1103088 840779-01225-1</p> <p>1</p>
<b>Lanyards</b>			
 <p>1246306</p>	 <p>1244610</p>	<p><b>3M™ DBI-SALA® EZ-Stop™ Arc Flash</b></p> <ul style="list-style-type: none"> <li>• Nomex®/Kevlar® fiber web and shock pack</li> <li>• Ideal for high heat environments</li> <li>• Snap hooks at each end</li> <li>• 6 ft (1.8m)</li> <li>• Meets ASTM F887</li> </ul>	<p>Single-leg</p> <p>1246306 648250-16596-6</p> <p>1</p>
<p><b>3M™ DBI-SALA® ShockWave™ 2 Arc Flash</b></p> <ul style="list-style-type: none"> <li>• Tubular Nomex®/Kevlar® fiber web</li> <li>• Ideal for high heat environments</li> <li>• Snap hook at ends</li> <li>• 6 ft (1.8m)</li> <li>• Meets ASTM F887</li> </ul>			
<p>Single-leg</p> <p>1244610 648250-16138-8</p> <p>1</p>			

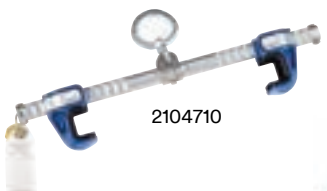
3M PPE products are for occupational use only. See warnings on page 126.

# 3M™ DBI-SALA® Fall Protection

Product	Description	Part / UPC	Qty
<b>Self-Retracting Lifeline</b>			
 3101491  3101499  3504430  3504552	<b>3M™ DBI-SALA® Nano-Lok™ Hot Works</b> <ul style="list-style-type: none"> <li>• Kevlar® fiber to withstand sparks/weld splatter/high heat</li> <li>• Steel Snap Hook</li> <li>• Single- and twin-leg connectors available</li> <li>• 6 ft (1.8m)</li> </ul>	Single-leg 3101491 648250-17149-3	1
	<b>3M™ DBI-SALA® Ultra-Lok™</b> <ul style="list-style-type: none"> <li>• 3/16" (5mm) galvanized steel cable</li> <li>• Thermoplastic housing</li> <li>• Steel swivel hook</li> <li>• 30 ft (9.1m)</li> </ul>	3504430 648250-16622-2	1
	<b>3M™ DBI-SALA® Ultra-Lok™ RSQ SRL</b> <ul style="list-style-type: none"> <li>• 3/16" (5mm) stainless steel cable</li> <li>• Exclusive RSQ Dual-Mode Decent</li> <li>• Stainless steel swivel hook</li> <li>• 50 ft (15.2m)</li> </ul>	3504552 840779-00220-7	1
<b>Anchor</b>			
 1002202  2104710  8513158	<b>3M™ DBI-SALA® Tie-Off Adapter</b> <ul style="list-style-type: none"> <li>• Kevlar® fiber web for high-heat environments</li> <li>• Pass-through type</li> <li>• 6 ft (1.8 m)</li> </ul>	1002202 840779-00781-3	1
	<b>3M™ DBI-SALA® Sliding Beam Anchor</b> <ul style="list-style-type: none"> <li>• Fits 3-1/2"- 14" wide I-beam flange up to 1-1/4" thick</li> <li>• Use above head or at feet</li> <li>• High strength steel and aluminum construction</li> <li>• 360° swiveling D-ring optimizes your mobility on the beams</li> </ul>	2104710 840779-15803-4	1
	<b>3M™ DBI-SALA® Tripod UCT-300</b> <ul style="list-style-type: none"> <li>• Telescoping adjustable locking legs</li> <li>• Lightweight, durable aluminum construction</li> <li>• 7 ft (2.13m), 450 lbs capacity</li> </ul>	8513158 840779-00880-3	1
<b>Self-Rescue</b>			
 3320030/3320031	<b>3M™ DBI-SALA® Self-Rescue Device</b> <ul style="list-style-type: none"> <li>• Detachable self-rescue system</li> <li>• Easily accessible primary release cord</li> <li>• Self-contained nylon pack with molded padding</li> <li>• Lightweight, low profile</li> <li>• Retrofits to virtually any safety harness</li> <li>• 50 ft and 100 ft lengths available</li> </ul>	50 ft (15.2m) 3320030 840779-14129-6	1
			100 ft (30.5m) 3320031 840779-14130-2
<b>Fall Protection for Tools</b>			
 1500130  1500089	<b>3M™ DBI-SALA® Utility Pouch</b> <ul style="list-style-type: none"> <li>• 2 inside pockets, 2 outside pockets</li> <li>• Tools can be tethered to D-rings</li> <li>• Zipper closure</li> </ul>	1500130 852684-93511-2	1
	<b>3M™ DBI-SALA® Adjustable Radio/Cell Phone Holster</b> <ul style="list-style-type: none"> <li>• Holster adjusts to fit many devices</li> <li>• Can be worn on belt or harness</li> <li>• Clip2Loop Coil Tether</li> <li>• Micro D-ring</li> </ul>	1500089 852684-93169-5	1

3M PPE products are for occupational use only. See warnings on page 126.

Safety Products

## Safety Warnings



### **! WARNING: RESPIRATORS**

These respirators help protect against certain airborne contaminants. Before use, the wearer must read and understand the User Instructions provided as a part of the product packaging. A written respiratory protection program must be implemented meeting all the requirements of OSHA 29 CFR 1910.134 including training, fit testing and medical evaluation. In Canada, CSA standards Z94.4 requirements must be met and/or requirements of the applicable jurisdiction, as appropriate. **Misuse may result in sickness or death.** For correct use, consult supervisor and User Instructions or call 3M Technical Service in the U.S.A. at 1-800-243-4630. In Canada, call 1-800-267-4414.

### **! WARNING: WELDING PRODUCTS**

These welding safety products must be used only by qualified persons trained in their use and maintenance and only in strict accordance with and adherence to the detailed instructions and precautionary statements provided in the instruction manual which accompanies each product. **Failure to comply with these instructions could result in sickness, serious bodily injury or death.** For correct use, consult supervisor and User Instructions and WARNINGS on the package. Any questions concerning proper use should be directed to your supervisor, on-site training specialist, industrial hygienist or 3M Technical Service in the U.S.A. at 1-800-243-4630. In Canada, call 1-800-267-4414.

### **! WARNING: HEARING PROTECTION**

These hearing protectors help reduce exposure to hazardous noise and other loud sounds. **Misuse or failure to wear hearing protectors at all times that you are exposed to noise may result in hearing loss or injury.** For correct use, consult supervisor and User Instruction, or call 3M Technical Service in the U.S.A. at 1-800-243-4630. In Canada, call 1-800-267-4414. If there is any drainage from your ear or you have an ear infection, consult with your physician before wearing earplugs. Failure to do so may result in hearing loss or injury.

### **! WARNING: PROTECTIVE EYEWEAR**

These eye and face protection products help provide limited eye and face protection. **Misuse or failure to follow warnings and instructions may result in serious potential injury, including blindness or death.** For proper use, selection, and applications against flying particles, optical radiation and/or splash, consult supervisor and User Instructions and warnings on package, or call 3M Technical Service in the U.S.A. at 1-800-243-4630. In Canada, call 1-800-267-4414.

### **! WARNING: FALL PROTECTION**

Compliant fall protection and emergency rescue systems help prevent serious injury during fall arrest. Users must read and understand the User Instructions provided with the product and be properly trained by their employer prior to use per OSHA 1910.66 and 1926.503 or applicable local standards. **Misuse or failure to follow warnings and instructions may result in serious personal injury or death.** For correct use, consult supervisor and User Instructions, or call 3M Technical Service in the U.S.A. at 1-800-243-4630. In Canada, call 1-800-267-4414.

## Three easy ways to contact us for all 3M Industrial Products

- ① Contact your local 3M authorized distributor directly. To find a 3M distributor or sales representative in your area, contact us at the numbers below:

For the contiguous 48 United States:

Call **1-866-279-1288**

FAX **1-877-369-2923**

- ② Email us at **3MIndustrial@mmm.com**
- ③ For additional product information: Call **1-800-3M Helps** or visit **3M.com**

Prices subject to change without notice.

**Product Use:** Many factors beyond 3M's control and uniquely within user's knowledge and control can affect the use and performance of a 3M product in a particular application. Given the variety of factors that can affect the use and performance of a 3M product, user is solely responsible for determining whether it is fit for a particular purpose and suitable for user's method of application.

**Warranty and Limited Remedy:** 3M warrants this tool against defects in workmanship and materials under normal operating conditions for one (1) year from the date of purchase. 3M MAKES NO OTHER WARRANTIES, EXPRESS OR IMPLIED, INCLUDING, BUT NOT LIMITED TO, ANY IMPLIED WARRANTY OF MERCHANTABILITY OR FITNESS FOR A PARTICULAR PURPOSE OR ANY IMPLIED WARRANTY ARISING OUT OF A COURSE OF DEALING, CUSTOM OR USAGE OF TRADE. User is responsible for determining whether the 3M tool is fit for a particular purpose and suitable for user's application. User must operate the tool in accordance with all applicable operating instructions, safety precautions, and other procedures stated in the operating manual to be entitled to warranty coverage. 3M shall have no obligation to repair or replace any tool or part that fails due to normal wear, inadequate or improper maintenance, inadequate cleaning, non-lubrication, improper operating environment, improper utilities, operator error or misuse, alteration or modification, mishandling, lack of reasonable care, or due to any accidental cause. If a tool or any part thereof is defective within this warranty period, your exclusive remedy and 3M's sole obligation will be, at 3M's option, to repair or replace the tool or refund the purchase price.

**Limitation of Liability:** Except where prohibited by law, 3M will not be liable for any loss or damage arising from the 3M product, whether direct, indirect, special, incidental or consequential, regardless of the legal theory asserted, including warranty, contract, negligence or strict liability.



3M Abrasive Systems Division  
3M Center  
Building 223-6S-03  
St. Paul, MN 55144-1000

3M.com/abrasives

3M, the color yellow for earplugs, Adflo, Classic, Cool Flow, Cubitron, DBI-SALA, Delta, E-A-R, E-A-Rsoft, ExoFit, ExoFit NEX, Express, EZ-Stop, Finesse-it, FX, Green Corps, Grippers, Hookit, Nano-Lok, One Touch, Optime, Pistonz, Pod Plugs, Push-Ins, Roloc, Scotch, Scotchgard, Scotch-Brite, Scotch-Seal, Scotch-Weld, SecureFit, Skull Screws, ShockWave, Solus, Speedglas, Stikit, STRATA, Super 77, SuperFit, Tartan, Tri-Flange, Tri-Lock Revolver, Trizact, UltraFit, Ultra-Lok, Versaflo, VHB, Wetordry, Yellow Neon Blasts and Yellow Neons are trademarks of 3M used under license in Canada. PELTOR is a trademark of 3M Svenska AB, used under license in Canada. Nomex® and Kevlar® are registered trademarks of E.I. du Pont de Nemours and Company or its affiliates.

Please recycle. Printed in U.S.A. © 3M 2020. All rights reserved. 61-5002-8280-3 Rev. 04/20